

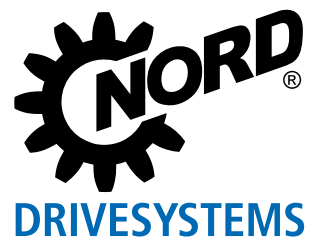

Frequency inverter for decentralised applications

NORDAC *FLEX* SK 200E series



Master of adaptation

NORDAC FLEX, SK 200E series



NORDAC FLEX

Frequency inverters are now essential components of electrical drive technology. They are used for a wide range of automation tasks in almost all fields of application.

Universal

The NORDAC FLEX, the all-rounder among decentralised frequency inverters, has established itself in almost all areas of engineering and industry.

This is due not only to the wide range of available powers (up to 22 kW - which by no means is something that can be taken for granted in decentralised drive technology) but also to the wide selection of functions and the flexibility offered by its comprehensive range of accessories.

Economical

The series has been structured with various function levels in order to take efficiency and customers' application-specific requirements into consideration. In addition, we have arranged the series into two equipment groups which optimally cater for typical customer applications for conveyors, pumps and fans.

Energy-saving

Even, or especially for applications in which a frequency inverter is not strictly necessary from a technical point of view (constant speed with 50 Hz), the NORDAC FLEX beats every unregulated drive unit with its enormous energy-saving characteristics, particularly in partial load operation



Basic configuration

- Sensorless **current vector control** and **V/f characteristic curve**
- 4 switchable **parameter sets** for flexible use of parameter settings
- All common **drive functions** e.g. acceleration / braking on a ramp, PI controller
- **Parameters** with pre-set standard values
- **POSICON** for relative and absolute positioning
- **Incremental encoder interface** for speed feedback
- **Stator resistance measurement**
- **PLC functionality** for drive-related functions
- Operation of **three-phase asynchronous motors (ASM) and permanent magnet synchronous motors (PMSM)**

Optional

- Interfaces for **8 field bus systems at present**
- **Various control options** (switch, potentiometer or control and parameterisation units)
- Versions with **functional safety** (Safe Stop)
- **IO modules** for additional analogue and digital inputs and outputs
- **System plug connectors** for power connection of mains and motor cables (industrial plug connectors) as well as for control and signal cables (M12 plug connectors)
- **ATEX versions** for operation in zone 22-3D

Pump/fan applications with the SK 2x0E

1~	230 V	0.25	-	0.55 kW
3~	230 V	0.25	-	11.0 kW
3~	400 V	0.55	-	22.0 kW

Typical requirements

- ▶ Speed setpoints/process signals via analogue input, e.g. pressure sensors
- ▶ Stand-alone operation of individual drive units or mobile systems, thanks to integrated control voltage
- ▶ No motor or brake control necessary



Conveyor applications with SK 2x5E (SK 2x0E, Size 4)

1~	115 V	0.25	-	0.75 kW
1~	230 V	0.25	-	1.1 kW
3~	230 V	0.25	-	4.0 kW (11.0 kW)
3~	400 V	0.55	-	7.5 kW (22.0 kW)

Typical requirements

- ▶ Separate voltage levels 400 V / 24 V, e.g. for separate start-up of bus system / control level and power
- ▶ Adjustable brake control with integrated rectifier
- ▶ No processing of analogue values required as bus control is frequently used

Basic configuration SK 2x0E series



4 digital inputs

e.g. for left/right enabling, fixed frequencies or parameter set switchover



2 digital outputs

e.g. for reporting errors or various limit values



1 or 2 analogue inputs

e.g. connection for speed setpoint or process signals



Integrated 24 V power supply

24 V control voltage for stand-alone operation

Basic configuration SK 2x5E series



4 digital inputs

e.g. for left/right enabling, fixed frequencies or parameter set switchover



1 digital output

e.g. for reporting errors or various limit values



Connection for external 24 V power supply

Separate voltage levels for power and control, e.g. for separate start-up or online availability when the power is switched off



Integrated brake rectifier

Application and release time optimally adjustable via parameter

BRE

If you are looking for a controlled drive unit

If you are looking for a drive unit with which your machine can perform specific functions.

We can supply the optimum device. A drive unit consisting of a combination of series production units that is perfectly tailored to your requirements. A drive unit which can be easily retrofitted with a wide range of accessories to adapt it to changed conditions.

If you have: Limited space



- ▶ Restricted installation space in the machine

High performance requirements



- ▶ High-performance drive units
- ▶ High breakaway torques

A need for high-precision speed control



- ▶ Speed fluctuations are not permissible
- ▶ Perfect load take-up (lifting equipment) is required
- ▶ Compensation for fluctuating loads (conveyor belts/conveying equipment)

A need for high-precision positioning



- ▶ Master-slave synchronisation
- ▶ Movement to fixed positions (storage and retrieval machines)
- ▶ Movement to relative positions (endless belts in bottling plants)
- ▶ Movement of a drive unit to a changing position of a moving drive system (flying saw)

A need for high flexibility



- ▶ Short timeframe in case of service
- ▶ Frequent changes of use of your machine
- ▶ Existing motor and gear unit

A need for plug and play



- ▶ E.g. for large projects or series production machinery
- ▶ Replacement devices for 1:1 exchange in case of service

A need for sustainability



- ▶ Resource-saving operation
- ▶ Use of products with low levels of hazardous substances

Our solution: Space-saving

- ▶ A compact device designed for the smallest possible overall dimensions
- ▶ Integrable optional modules (e.g. interfaces for field bus connection)
- ▶ Wall mounting kits for installation close to the motor



Powerful

- ▶ Unbeatable power range from 0.25 kW to 22.0 kW
- ▶ Optimised for continuous operation in 4 matching sizes
- ▶ Genuinely usable overload reserves of up to 200% of the rated power



Fast

- ▶ Comprehensive measuring methods for recording the actual electrical data as the basis for excellent control of the drive unit
- ▶ Integrated, precise and fast-acting current vector control for immediate adaptation to actual load conditions
- ▶ Integrated interface for connection of an incremental encoder to detect the actual motor speed (prerequisite for precise control)



Precise

- ▶ Integrated, precise, fast and completely autonomous positioning function (POSICON)
- ▶ Integrated interface for connection of an absolute encoder to detect the actual position



Adaptable

- ▶ Integrated DIP switches for basic configuration without modification of the software
- ▶ Comprehensive selection of plug connectors for control and power cable connections
- ▶ Easily accessible exchangeable data carrier (EEPROM) for simple exchange of parameter settings between identical devices
- ▶ Devices can also be supplied individually



Configurable

- ▶ Mounted on the geared motor
- ▶ Equipped with the necessary accessories (braking resistor, bus interface, encoders, etc.)
- ▶ Pre-parameterised for the specified drive application
- ▶ Equipped with the necessary system plug connectors







Environmentally friendly

- ▶ Low-loss use of energy
- ▶ Energy-saving function to match the power output to the actual demand in partial load operation
- ▶ Consideration of environmental protection even during manufacture (e.g. RoHS)



Standards and approvals

All devices of the entire series comply with the standards and directives listed below.

Approval	Directive	Applied standards	Certificates	Code
CE (European Union)	Low Voltage Directive 2014/35/EU	EN 61800-5-1	C310700	
	EMC 2014/30/EU	EN 60529	C310401	
	RoHS 2011/65/EU	EN 61800-3 EN 63000		
	Delegated directive (EU) 2015/863	EN 61800-9-1 EN 61800-9-2		
	Ecodesign 2009/125/EG			
	Regulation (EU) 2019/1781 Ecodesign			
UL (USA)		UL 61800-5-1	E171342	
CSA (Canada)		C22.2 No. 274-13	E171342	
RCM (Australia)	F2018L00028	EN 61800-3	133520966	
EAC (Eurasia)	TR CU 004/2011, TR CU 020/2011	IEC 61800-5-1 IEC 61800-3	EAЭС N RU Д-DE. HB27.B.02727/20	
UkrSEPRO (Ukraine)		EN 61800-5-1 EN 60529 EN 61800-3 EN 63000 EN 60947-1 EN 60947-4 EN 61558-1 EN 50581	C311900	
UKCA (United Kingdom)		EN 61800-5-1 EN 60529 EN 61800-3 EN 63000 EN 61800-9-1 EN 61800-9-2	C350700, C350401	

Devices which are configured and approved for use in explosion hazard environments comply with the following directives and standards.

Approval	Directive	Applied standards	Certificates	Code
CE (European Union)	LATEX	2014/34/EU	EN 60079-0	C432410
	Low Voltage Directive	2014/35/EU	EN 60079-31	
	EMC	2014/30/EU	EN 61800-5-1	
	RoHS	2011/65/EU	EN 60529	
	Delegated directive (EU)	2015/863	EN 61800-3	
	Ecodesign	2009/125/EG	EN 63000	
	Regulation (EU)	2019/1781	EN 61800-9-1	
	Ecodesign		EN 61800-9-2	

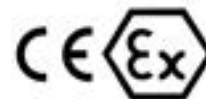

Type code

Frequency inverter - Basic device

SK 205E-370-323-A (-C) (xxx)

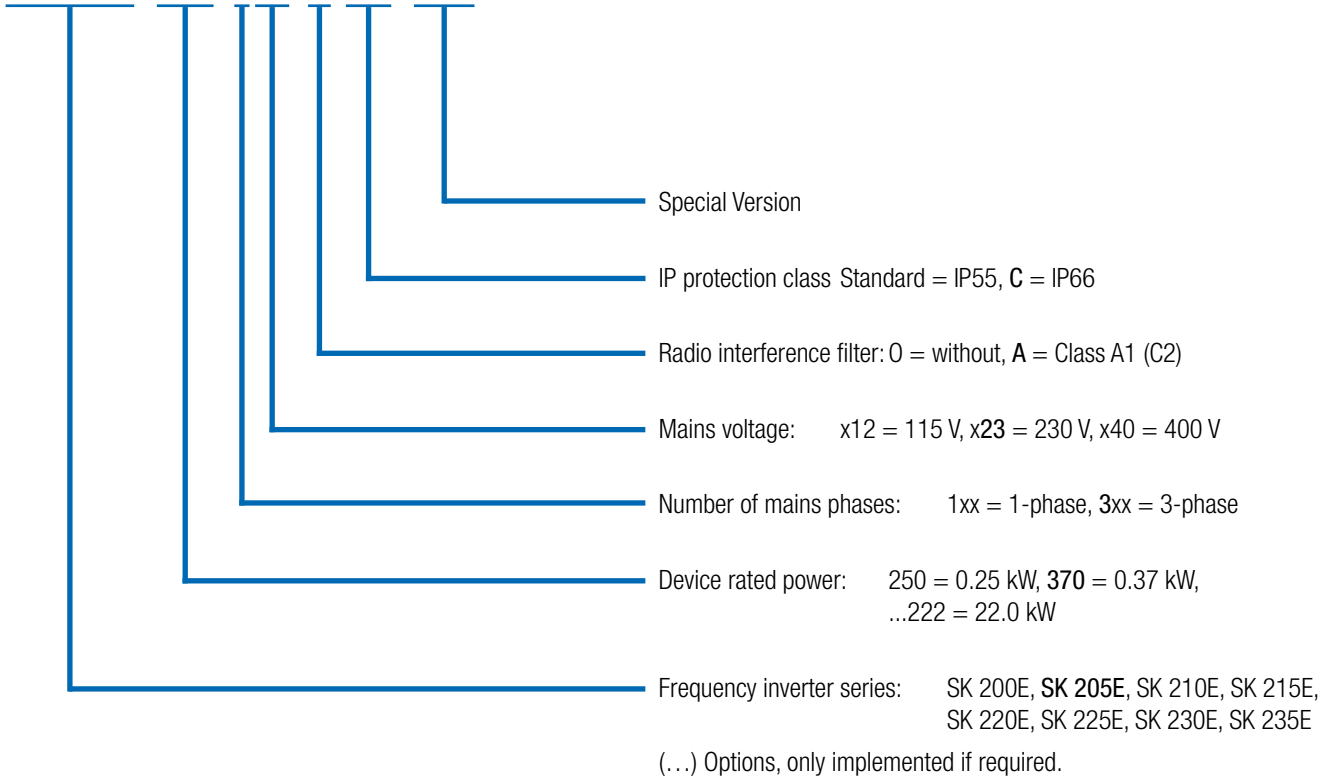

Frequency inverter - Connection unit

SK TI4-1-205-1 (-C-EX)

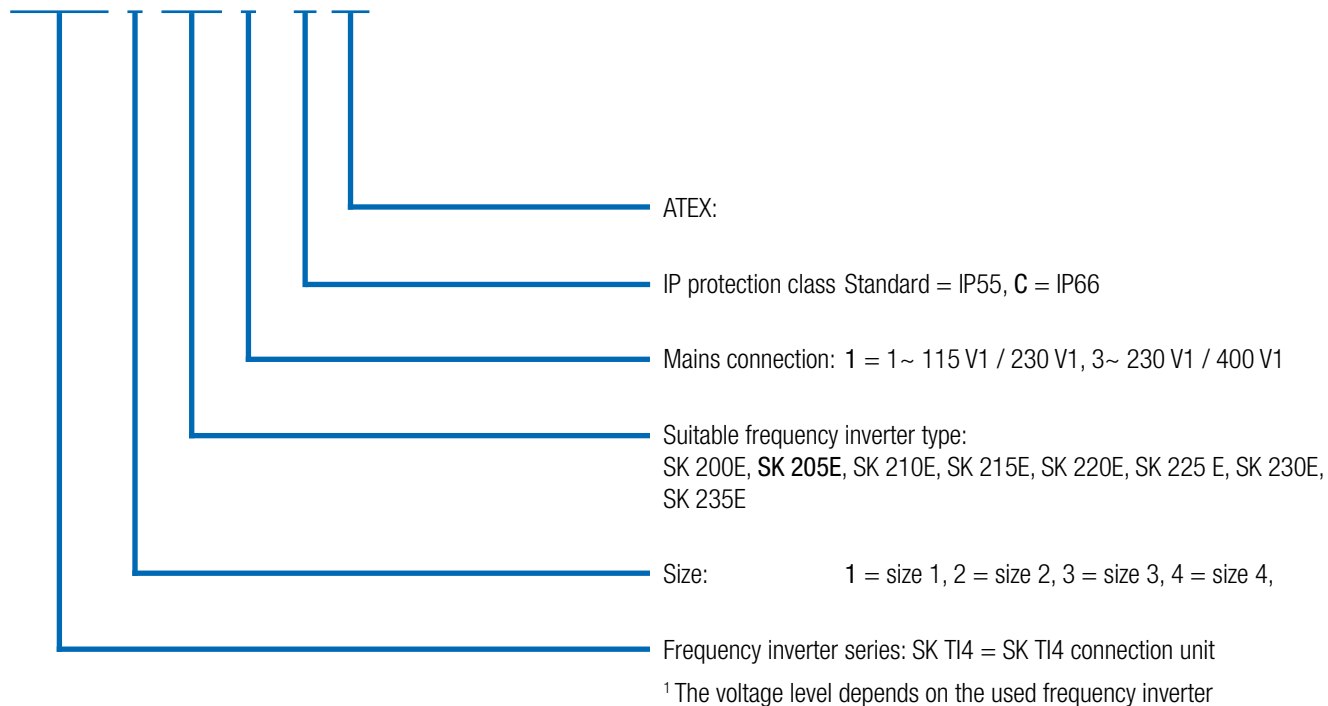

Versatile and sustainable

The frequency inverter with „servo genes“

CANopen



Standard encoder interfaces

The frequency inverters' speed control is extremely precise thanks to sophisticated and fast measuring methods and calculation algorithms in combination with integrated high-precision current vector control.

However, there are applications where precision of a thousandth of a motor revolution and very high dynamics (maximum acceleration, cyclic operation, synchronous rotation relative to other drive units) are needed. In such cases, precise feedback from the mechanical momentary values of the motor or the drive unit is required. This feedback is provided by **incremental encoders**, which are normally mounted on the motor shaft and provide information about its actual position. These values enable the motor to be precisely controlled by the frequency inverter so that even with large load fluctuations an asynchronous motor can be operated with a performance similar to that of a servo motor.

Absolute encoders round off the concept so that high-precision drive applications such as

- ▶ Synchronisation of multiple drive units
- ▶ Dynamic synchronisation of a drive unit to a different drive unit (flying saw)
- ▶ Relative positioning tasks (cyclical drives)
- ▶ Absolute positioning tasks (automatic warehouse equipment / high-bay storage, lifting equipment with defined positions)

are possible.

Each frequency inverter is equipped with a corresponding interface.

- ▶ HTL incremental encoder interface (connection via 2 digital inputs) - primarily for speed control
- ▶ CANopen absolute encoder interface (connection via system bus) - primarily for positioning

Available in all size

Modern automation systems



Power
(115 V / 230 V / 400 V)

AS-Interface
including 24 V supply SK 2xxE

Modern automation systems have a wide range of requirements, so that a suitable bus system and drive components must be selected in order to ensure efficient implementation.

For the lower field level, the AS-Interface is a cost-effective solution which enables the networking of binary sensors and actuators. With NORDAC *FLEX*, special versions which provide an appropriate solution by means of an **AS-Interface**, are available for this price-sensitive area.

The supply voltage (power) is connected separately via the corresponding terminals. Depending on the version of the device, the control voltage of the frequency inverter is generated either via an integrated power supply unit or is supplied separately via the yellow AS-Interface cable. This eliminates the need for an additional AUX cable (black). The type of addressing possible (standard or A/B slaves) also depends on the version of the device.

Device SK ...	220E/230E	225E/235E
Slave profile	S-7.A.	S-7.0.
Slave type	A/B-Slave	Standard
Control voltage	Internal power supply	Yellow AS-I cable
Inputs/Outputs	4/4	4/4
Configuration via DIP switch	●	●
Configuration via parameters	●	●

ATEX-compliant drive systems, zone 22 3D

Size 1-3 devices can be modified for operation in explosive atmospheres.

This allows the operation of the frequency inverter directly in a hazardous area (ATEX 22-3D). The advantages are obvious:

- ▶ Compact drive unit
- ▶ No complex protective devices
- ▶ No motor cables
- ▶ Optimum EMC
- ▶ Permissible characteristic curves 50 Hz / 87 Hz
- ▶ Control range up to 100 Hz or 3000 rpm

Depending on the area of application (conductive or non-conductive dust) the modification includes, among others, replacement of the transparent diagnostic caps with a version made of aluminium and glass.

It must be noted that operation of the device within the hazard area is only permitted with integrable modules (SK CU4 modules, internal brake resistors) or specially approved accessories (ATEX potentiometer „SK ATX-POT“).

There are exceptions for SK TU4 modules, which are described in detail in the manual for the device. Other accessories (e.g. external brake resistors, plug connectors) are not approved for use within a hazardous area.



Approval

- ▶ According to 2014/34/EU
- ▶ ATEX Zone 22 - 3D
 - ▶ Version for non-conducting dust: IP55
 - ▶ Version for conducting dust: IP66

Available in all size 1-3 devices



The entire team

All device versions at a glance

	SK 200E	SK 210E	SK 220E	SK 230E	SK 205E	SK 215E	SK 225E	SK 235E
	Size 1-4, 0.25 - 22.0 kW				Size 1-3, 0.25 - 7.5 kW			
Motor and wall mounting possible ¹	●	●	●	●	●	●	●	●
Energy bus - loop-through of mains supply cables ²	●	●	●	●	●	●	●	●
Communication bus for various devices ²	●	●	●	●	●	●	●	●
Sensorless current vector control (ISD control)	●	●	●	●	●	●	●	●
Brake chopper (brake resistor optional)	●	●	●	●	●	●	●	●
RS-232 diagnostic interface	●	●	●	●	●	●	●	●
4 switchable parameter sets	●	●	●	●	●	●	●	●
Parameters pre-set with standard values	●	●	●	●	●	●	●	●
Automatic determination of motor data	●	●	●	●	●	●	●	●
Energy-saving function, optimised efficiency in partial load operation	●	●	●	●	●	●	●	●
Integrated EMC line filter according to EN 61800-3, Category C2 up to 5 m motor cable and for motor assembly	●	●	●	●	●	●	●	●
Extensive monitoring functions	●	●	●	●	●	●	●	●
Load monitor	●	●	●	●	●	●	●	●
PI controller	●	●	●	●	●	●	●	●
Process controller / compensator control	●	●	●	●	●	●	●	●
Plug-in memory module (EEPROM)	●	●	●	●	●	●	●	●
Incremental encoder evaluation (speed control)	●	●	●	●	●	●	●	●
POSICON positioning control	●	●	●	●	●	●	●	●
PLC functionality	●	●	●	●	●	●	●	●
Synchronous motor operation (PMSM)	●	●	●	●	●	●	●	●
Modification for operation in an IT network by means of jumpers	●	●	●	●	●	●	●	●
All common field bus systems	●	●	●	●	●	●	●	●
Brake management for mechanical holding brake	● ³	● ³	● ³	● ³	●	●	●	●
Lifting gear functionality	●	●	●	● ³	●	●	●	●
Safe Stop function (STO, SS1)	○	●	○	●	○	●	○	●
AS-Interface on board	○	○	●	●	○	○	●	●
Evacuation run	○ ³	○ ³	○ ³	○ ³	●	●	●	●
Internal 24 V power supply unit to supply the control board	●	●	●	●	●	●	●	●
External 24 V power supply for the control board	● ⁴	● ⁴	● ⁴	● ⁴	●	●	●	●
Internal / external braking resistors	●	●	●	●	●	●	●	●
Switch and potentiometer versions	●	●	●	●	●	●	●	●
Plug connectors for connection of control, motor and mains cables	●	●	●	●	●	●	●	●

¹ Wall mounting: wall mounting kit required
 Motor mounting: an adapter for connection to the motor terminal box may be necessary.

² Direct connection to the terminal bar or via system plug connectors

³ Size 4: standard

⁴ Size 1 -3: no, Size 4: optional

● Available as standard

● Optional

○ Not available

The senses

Control connections on the frequency inverter

	SK 200E	SK 210E	SK 220E	SK 230E	SK 200E	SK 210E	SK 220E	SK 230E	SK 205E	SK 215E	SK 225E	SK 235E	
	Size 1-3, 0.25 - 7.5 kW				Size 4, 11 - 22.0 kW				Size 1-3, 0.25 - 7.5 kW				
Control terminals	Number of digital inputs (DIN)	4	3	4	3	4	3	4	3	4	3	4	3
	Fail-safe digital input	○	●	○	●	○	●	○	●	○	●	○	●
	Number of digital outputs (DOUT)	2	2	2	2	2	2	2	2	1	1	1	1
	Number of analogue inputs (AIN) ¹	2	2	1	1	2	2	2	2	○	○	○	○
	Integrated brake rectifier	○	○	○	○	●	●	●	●	●	●	●	●
	Temperature sensor (PTC)	●	●	●	●	●	●	●	●	●	●	●	●
	Encoder interfaces	HTL	●	●	●	●	●	●	●	●	●	●	●
CANopen ^{®2}		●	●	●	●	●	●	●	●	●	●	●	●
Communication	RS 485 / RS232	●	●	●	●	●	●	●	●	●	●	●	●
	AS-I	○	○	●	●	○	○	●	●	○	○	●	●

¹ 0(2) - 10 V, 0(4) - 20 mA
² via system bus

Note

Control terminals can be supplemented by optional modules (IOs, brake management).

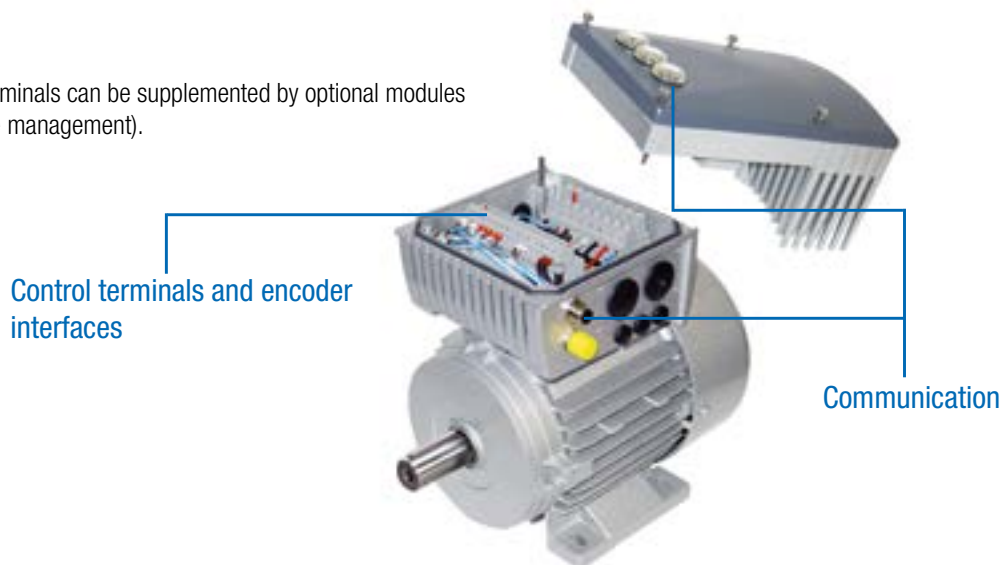

Configuration and monitoring

Integrated aids for safe operation

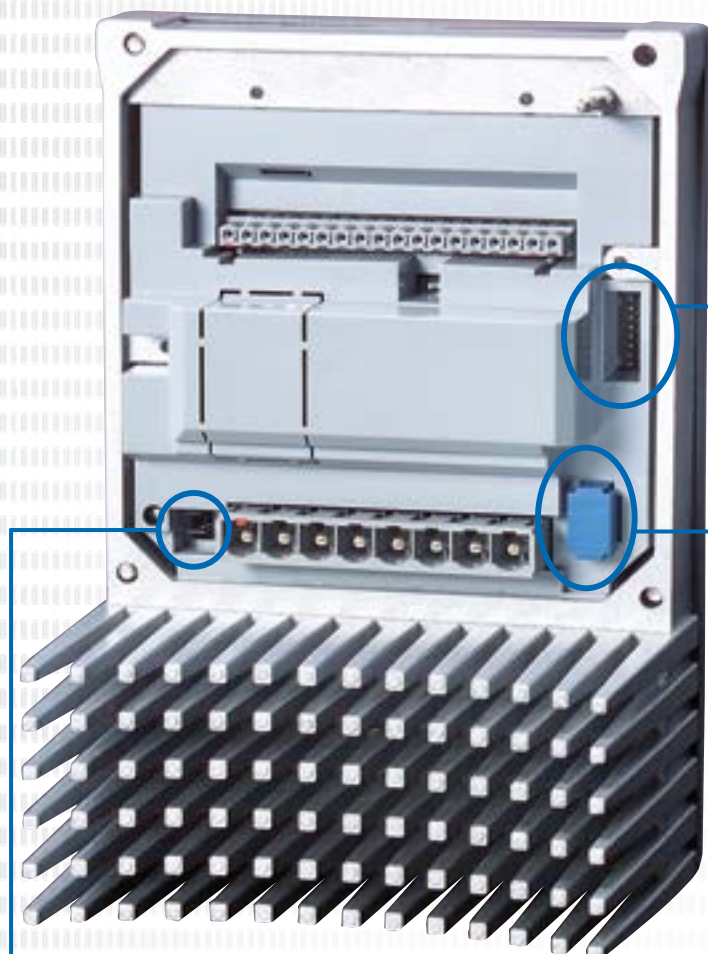

Commissioning with a screwdriver

Various basic functions can be simply set via easily accessible DIP switches so that commissioning is possible without parameterisation software. Even when an EEPROM is plugged in, the DIP switch settings have priority over the relevant parameters.



Plug-in EEPROM

The frequency inverter is equipped with two EEPROMs for saving the individual parameter settings of the device. One EEPROM is integrated into the device and another EEPROM can be plugged in and is easily accessible. All parameter settings are managed by the internal EEPROM. The data is mirrored to the external EEPROM. Because of the easy access, data sets can be exchanged between identical drive units via the plug-in EEPROM. Via an optional parameterisation adapter (SK EPG-3H) devices can be parameterised „in the laboratory“ so that only the plug-in EEPROM needs to be transferred between the system and the „laboratory“.

Jumpers for mains adaptation

It is possible to adapt the frequency inverter for operation in an IT network by plugging in a jumper. However, this adaptation has a negative effect on the emission of electromagnetic interference. Compliance with the specified degree of radio interference suppression can no longer be guaranteed in this case.

Status and diagnostic cockpit

Depending on the type of device, various aids for monitoring the device or for diagnostics in case of faults are located behind 3 transparent cover caps. In addition, there are further elements (e.g. DIP switches or similar) which are useful for screwdriver-assisted commissioning.



Example: SK 2x0E

SK 2x0E in Sizes 1-3

(Size 4 as for SK 2x5E)

1 Diagnostic interface, RS-232 and RS-485

RJ12 interface for connection of a diagnostic and parameterisation tool (e.g. PC with NORDCON software, ParameterBox). Analysis, diagnostics, parameterisation and monitoring of the drive unit via software is possible during commissioning or service.

2 DIP switches for analogue inputs

The integrated analogue inputs of the device can be configured to the signal form of setpoint values (current or voltage) via the DIP switches.

3 Status LED for frequency inverter and system bus

In addition to status and readiness indicators, the current overload level, warnings and error messages are indicated in coded form by the LEDs

SK 2x5E and SK 2x0E in Size 4

1 Diagnostic interface, RS-232 and RS-485

RJ12 interface for connection of a diagnostic and parameterisation tool (e.g. PC with NORDCON software, ParameterBox). Analysis, diagnostics, parameterisation and monitoring of the drive unit via software is possible during commissioning or service.

2 Status and diagnostic LEDs

In addition to the operating status of the system bus, various signal statuses (e.g. of the digital IOs) can be read out here.

3 Potentiometer and status LEDs

The two potentiometers are used for the fixed setting of various dynamic factors (setpoint frequency, frequency band, acceleration time). The two diagnostic LEDs indicate the operating statuses and error messages of the device or the AS-Interface (if present).

NORDAC *FLEX* frequency inverter

1~ 110 ... 120 V and 1/3~ 200 ... 240 V

Output frequency	0.0 ... 400.0 Hz	Protection class	IP55, optionally IP66, NEMA type1 (higher NEMA classifications on request)
Pulse frequency	3.0 ... 16.0 kHz	Regulation and control	Sensorless current vector control (ISD), linear V/f characteristic curve
Typical overload capacity	150 % for 60 s, 200 % for 3.5 s	Motor temperature monitoring	I ² t Motor PTC / bi-metal switch
Energy efficiency class	IE2	Leakage current	<40 mA for standard configuration of integrated line filter <20 mA for configuration for "operation on IT network"
Efficiency	> 95 %		
Ambient temperature	-25 °C ... +50 °C (depending on type of operation)		

Frequency inverters SK 2xxE ...	SK 2x0E	SK 2x5E	Nominal motor power		Nominal output current rms [A]	Mains voltage	Output voltage
			230 V [kW]	240 V [hp]			
-250-112-0 (-C)	○	●	0.25	1/3	1.7	1~ 110 ... 120 V, +/- 10 %, 47 ... 63 Hz	3~ 0 up to double the mains voltage
-370-112-0 (-C)	○	●	0.37	1/2	2.2		
-550-112-0 (-C)	○	●	0.55	3/4	3.0		
-750-112-0 (-C)	○	●	0.75	1	4.0		

Frequency inverters SK 2xxE ...	SK 2x0E	SK 2x5E	Nominal motor power		Nominal output current rms [A]	Mains voltage	Output voltage
			230 V [kW]	240 V [hp]			
-250-123-A (-C)	●	●	0.25	1/3	1.7	1~ 200 ... 240 V +/-10 % 47 ... 63 Hz	3 AC 0 – 200 ... 240 V
-370-123-A (-C)	●	●	0.37	1/2	2.2		
-550-123-A (-C)	●	●	0.55	3/4	3.0		
-750-123-A (-C)	○	●	0.75	1	4.0		
-111-123-A (-C)	○	●	1.1	1 1/2	5.5		

Frequency inverters SK 2xxE ...	SK 2x0E	SK 2x5E	Nominal motor power		Nominal output current rms [A]	Mains voltage	Output voltage
			230 V [kW]	240 V [hp]			
-250-323-A (-C)	●	●	0.25	1/3	1.7	3~ 200 ... 240 V, +/- 10 %, 47 ... 63 Hz	3~ 0 up to mains voltage
-370-323-A (-C)	●	●	0.37	1/2	2.2		
-550-323-A (-C)	●	●	0.55	3/4	3.0		
-750-323-A (-C)	●	●	0.75	1	4.0		
-111-323-A (-C)	●	●	1.1	1 1/2	5.5		
-151-323-A (-C)	●	●	1.5	2	7.0		
-221-323-A (-C)	●	●	2.2	3	9.5		
-301-323-A (-C)	●	●	3.0	4	12.5		
-401-323-A (-C)	●	●	4.0	5	16.0		
-551-323-A (-C)	●	○	5.5	7 1/2	23.0		
-751-323-A (-C)	●	○	7.5	10	29.0		
-112-323-A (-C)	●	○	11.0	15	40.0		

- Available as standard
- Not available

IP66 measures

- ▶ Coated aluminium components
- ▶ Coated circuit boards
- ▶ Low-pressure test
- ▶ Diaphragm valve

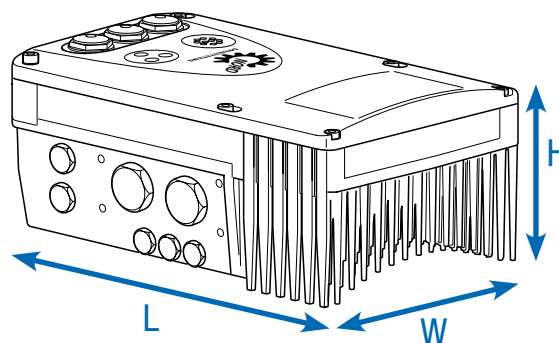

Frequency inverters SK 2xxE ...	SK 2x0E	SK 2x5E	Weight [kg]	(Overall) dimensions L x W x H [mm]	Size
-250-112-0 (-C)	○	●	3.0	236 x 156 x 127	1
-370-112-0 (-C)	○	●	3.0	236 x 156 x 127	1
-550-112-0 (-C)	○	●	4.1	266 x 176 x 134	2
-750-112-0 (-C)	○	●	4.1	266 x 176 x 134	2

Frequency inverters SK 2xxE ...	SK 2x0E	SK 2x5E	Weight [kg]	(Overall) dimensions L x W x H [mm]	Size
-250-123-A (-C)	●	●	3.0	236 x 156 x 127	1
-370-123-A (-C)	●	●	3.0	236 x 156 x 127	1
-550-123-A (-C)	●	●	3.0	236 x 156 x 127	1
-750-123-A (-C)	○	●	4.1	266 x 176 x 134	2
-111-123-A (-C)	○	●	4.1	266 x 176 x 134	2

Frequency inverters SK 2xxE ...	SK 2x0E	SK 2x5E	Weight [kg]	(Overall) dimensions L x W x H [mm]	Size
-250-323-A (-C)	●	●	3.0	236 x 156 x 127	1
-370-323-A (-C)	●	●	3.0	236 x 156 x 127	1
-550-323-A (-C)	●	●	3.0	236 x 156 x 127	1
-750-323-A (-C)	●	●	3.0	236 x 156 x 127	1
-111-323-A (-C)	●	●	3.0	236 x 156 x 127	1
-151-323-A (-C)	●	●	4.1	266 x 176 x 134	2
-221-323-A (-C)	●	●	4.1	266 x 176 x 134	2
-301-323-A (-C)	●	●	6.9	330 x 218 x 144	3
-401-323-A (-C)	●	●	6.9	330 x 218 x 144	3
-551-323-A (-C)	●	○	17.0	480 x 305 x 160	4
-751-323-A (-C)	●	○	17.0	480 x 305 x 160	4
-112-323-A (-C)	●	○	17.0	480 x 305 x 160	4

- Available as standard
- Not available

NORDAC *FLEX* frequency inverter

3~ 380 ... 500 V

Output frequency	0.0 ... 400.0 Hz	Protection class	IP55, optionally IP66, NEMA type1 (higher NEMA classifications on request)
Pulse frequency	3.0 ... 16.0 kHz	Regulation and control	Sensorless current vector control (ISD), linear V/f characteristic curve
Typical overload capacity	150 % for 60 s, 200 % for 3.5 s	Motor temperature monitoring	I ² t Motor PTC / bi-metal switch
Efficiency	> 95 %	Leakage current	<40 mA for standard configuration of integrated line filter <20 mA for configuration for "operation on IT network"
Ambient temperature	-25 °C ... +50 °C (depending on type of operation)		

Frequency inverters SK 2xxE ...	SK 2x0E	SK 2x5E	Nominal motor power		Nominal output current rms [A]	Mains voltage	Output voltage
			400 V [kW]	480 V [hp]			
-550-340-A	●	●	0.55	3/4	1.7	3~ 380 ... 500 V, -20 % / +10 %, 47 ... 63 Hz	3~ 0 up to mains voltage
-750-340-A	●	●	0.75	1	2.3		
-111-340-A	●	●	1.1	1 1/2	3.1		
-151-340-A	●	●	1.5	2	4.0		
-221-340-A	●	●	2.2	3	5.5		
-301-340-A	●	●	3.0	4	7.5		
-401-340-A	●	●	4.0	5	9.5		
-551-340-A	●	●	5.5	7 1/2	12.5		
-751-340-A	●	●	7.5	10	16.0		
-112-340-A	●	○	11.0	15	23.0		
-152-340-A	●	○	15.0	20	32.0		
-182-340-A	●	○	18.5	25	40.0		
-222-340-A	●	○	22.0	30	46.0		

- Available as standard
- Not available

IP66 measures

- ▶ Coated aluminium components
- ▶ Coated circuit boards
- ▶ Low-pressure test
- ▶ Diaphragm valve

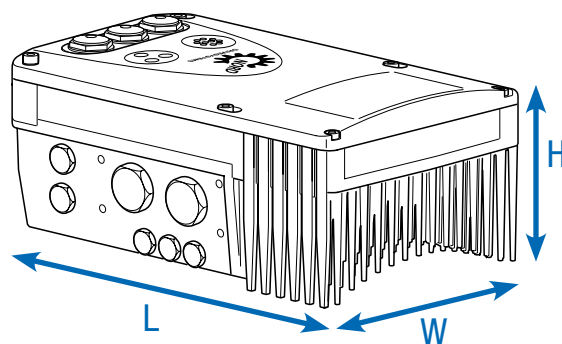

Frequency inverters SK 2xxE ...	SK 2x0E	SK 2x5E	Weight [kg]	(Overall) dimensions L x W x H [mm]	Size
-550-340-A	●	●	3.0	236 x 156 x 127	1
-750-340-A	●	●	3.0	236 x 156 x 127	1
-111-340-A	●	●	3.0	236 x 156 x 127	1
-151-340-A	●	●	3.0	236 x 156 x 127	1
-221-340-A	●	●	3.0	236 x 156 x 127	1
-301-340-A	●	●	4.1	266 x 176 x 134	2
-401-340-A	●	●	4.1	266 x 176 x 134	2
-551-340-A	●	●	6.9	330 x 218 x 144	3
-751-340-A	●	●	6.9	330 x 218 x 144	3
-112-340-A	●	○	17.0	480 x 305 x 160	4
-152-340-A	●	○	17.0	480 x 305 x 160	4
-182-340-A	●	○	17.0	480 x 305 x 160	4
-222-340-A	●	○	17.0	480 x 305 x 160	4

- Available as standard
- Not available

We bring together what belongs together

The NORDAC *FLEX*

consists of 2 elements – the actual frequency inverter and a suitable connection unit. The connection unit contains all device-specific connection terminals and a space for the supplement of an optional SK CU4-... module (internal control terminal).



The NORDAC *FLEX* is usually directly mounted on a motor.

The NORDAC *FLEX* can be combined with motors from various power and efficiency classes. Depending on the motor with which the frequency inverter is combined, the mounting on the terminal box base of the motor may require an additional mounting adapter.

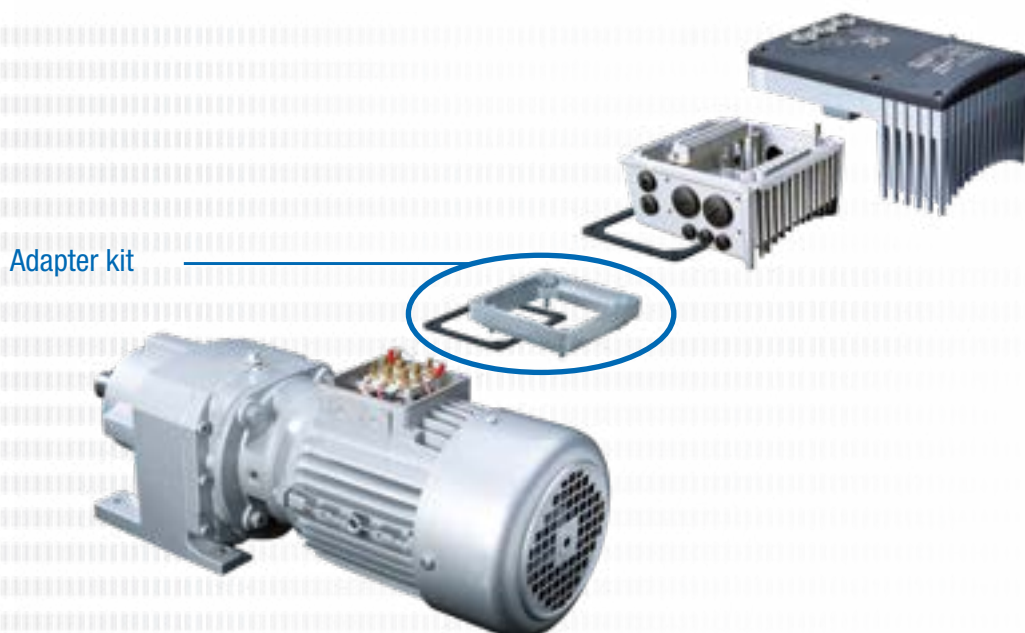

Adjustments for motor mounting

The terminal box fixations partially differ between the single motor sizes. It may therefore necessary for the device structure to use adapters.

To ensure the device's maximum IPxx protection class for the entire unit, all elements of the drive unit (e.g.

motor) must comply with the same protection class. NORDAC *FLEX* can also be combined with IE5+ motors from NORD. The frequency inverter output matches the motor power.

Size NORD motors	Attachment SK 2xxE BG 1	Attachment SK 2xxE BG 2	Attachment SK 2xxE BG 3	Attachment SK 2xxE BG 4
BG 63 – 71	With adapter kit I	With adapter kit I	nicht möglich	Not possible
BG 80 – 112	Direct mounting	Direct mounting	With adapter kit II	Not possible
BG 132	Not possible	Not possible	Direct mounting	With adapter kit III
BG 160-180	Not possible	Not possible	Not possible	Direct mounting

Adapter kit designation	Protection class	Designation	Components	Material No.
Adapter kit I	IP55	TI4-12-Adapterkit_63-71	Adapter plate, terminal box Frame seal and screws	275 119 050
Adapter kit I	IP66	SK TI4-12-Adapterkit_63-71-C		275 274 324
Adapter kit II	IP55	SK TI4-3-Adapterkit_80-112	Adapter plate, terminal box Frame seal and screws	275 274 321
Adapter kit II	IP66	SK TI4-3-Adapterkit_80-112-C		275 274 325
Adapter kit III	IP55	SK TI4-4-Adapterkit_132	Adapter plate, terminal box Frame seal and screws	275 274 320
Adapter kit III	IP66	SK TI4-4-Adapterkit_132-C		275 274 326

Varied installation possibilities

Motor Assembly

The frequency inverter can be mounted directly on the terminal box of the (geared) motor, thus forming a perfect unit consisting of the drive and the control technology. This motor-mounted format makes full use of its unbeatable advantages: compact overall dimensions of the drive unit, practically immediate readiness for use after connection to the mains supply thanks to the pre-configuration of the drive unit at the factory, optimum EMC due to short cable lengths - or elimination of a motor cable.

Wall mounting

As an alternative to motor mounting, the device can be mounted close to the motor with the aid of an optional wall mounting kit.

You can select from different versions depending on the prevalent ambient conditions.

1. Standard version

SK TIE4-WMK-1-K (-2-K or -3)

Note: If the frequency inverter is wall mounted, the cooling air flow from the motor is not present. This can ultimately result in power restrictions (derating) for the frequency inverter.

2. Version with fan

SK TIE4-WMK-L-1 (or -L-2)

This version differs from the standard version due to an extra fan. The fan ensures a continuous flow of cooling air over the frequency inverter. This avoids derating due to wall mounting.

As standard, Size 4 frequency inverters are equipped with fans. A corresponding wall mounting kit is therefore not necessary and is not available.

3. ATEX version

SK TIE4-WMK-1-EX (up to -2-EX)

This version is functionally comparable to the standard version, however it is suitable for use in explosion hazard environments (ATEX Zone 22 3D).

Designation	Material No.	Frequency inverters ¹ for size FI
SK TIE4-WMK-1-K	275 274 004	BG 1, 2
SK TIE4-WMK-2-K	275 274 015	BG 3
SK TIE4-WMK-L-1	275 274 005	BG 1, 2
SK TIE4-WMK-L-1-C	275 274 016	BG 1, 2
SK TIE4-WMK-L-2	275 274 006	BG 3
SK TIE4-WMK-1-EX	275 175 053	BG 1, 2
SK TIE4-WMK-2-EX	275 175 054	BG 3
SK TIE4-WMK-3	275 274 003	BG 4
SK TIE4-WMK-TU ²	275 274 002	Typ: SK TU4-

¹ Mounting of the WMK on the connection unit of the frequency inverter

² Mounting of the WMK on the connection unit of the technology unit

Motor-mounted or wall-mounted frequency inverters

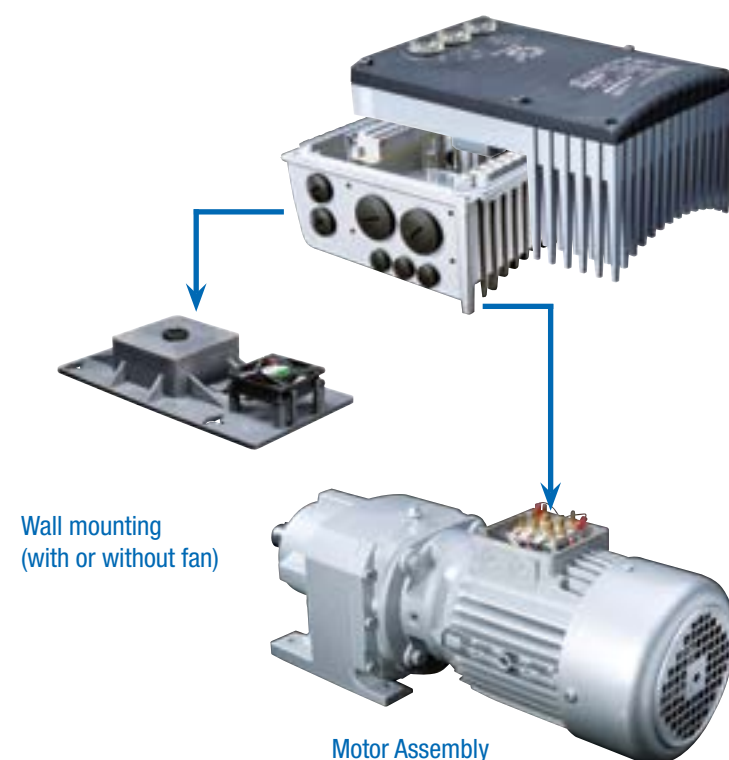

Designation	Material	Integrated fan	Achievable protection class	Weight [kg]	(Overall) dimensions L x W x H [mm]	Remarks
SK TIE4-WMK-1-K	Plastic	○	IP66	0,2	205 x 95 x 5	Note: derating as necessary
SK TIE4-WMK-2-K	Plastic	○	IP66	0,3	235 x 105 x 5	Note: derating as necessary
SK TIE4-WMK-L-1	Plastic	●	IP55	0,4	255 x 130 x 24	Fan power: 24 V DC, 1.3 W
SK TIE4-WMK-L-1-C	Plastic	●	IP66	0,4	255 x 130 x 24	Fan power: 24 V DC, 1.3 W
SK TIE4-WMK-L-2	Plastic	●	IP55	0,5	300 x 150 x 30	Note: derating as necessary
SK TIE4-WMK-1-EX	Stainless steel	○	IP66	0,6	205 x 95 x 4	Note: derating as necessary
SK TIE4-WMK-2-EX	Stainless steel	○	IP66	0,8	235 x 105 x 10	ggf. Derating beachten
SK TIE4-WMK-3	Stainless steel	○	IP66	2,4	295 x 255 x 8	
SK TIE4-WMK-TU	Stainless steel	○	IP66	0,4	155 x 85 x 3	

¹ H = increase in the total height of the device if mounted on the wall mounting kit

● Available as standard
○ Not available

Technology unit on NORDAC FLEX or wall mounting



Brake resistors

Internal version

Internal braking resistors SK BRI4

Internal braking resistors are intended for applications in which slight or only sporadic and brief braking (e.g. continuous conveyor equipment, mixing equipment) is to be expected. In addition, they enable the use of the frequency inverter in very confined spaces or in an explosive atmosphere.

Internal brake resistors are intended for installation in the connection unit of the frequency inverter. The devices provide space for the integration of one brake resistor or a set of 2 brake resistors (SK 2x0E, size 4). For thermal reasons, the rated continuous output is limited to 25%. A respective overload protection can be configured via DIP switch.



Frequency inverter SK 2xxE ...	Resistor type	Material No.	Resistance [Ω]	Continuous output [W]	Power consumption ² [kW]	
1 ~ 115 V	0.25 ... 0.75 kW	SK BRI4-1-100-100	275 272 005	100	100 / 25 %	1,0
	0.25 ... 1.1 kW	SK BRI4-1-100-100	275 272 005	100	100 / 25 %	1,0
3 ~ 230 V	0.25 ... 2.2 kW	SK BRI4-1-200-100	275 272 008	200	100 / 25 %	1,0
	3.0 ... 4.0 kW	SK BRI4-2-100-200	275 272 105	100	200 / 25 %	2,0
	5.5 ... 7.5 kW	SK BRI4-3-047-300	275 272 201	47	300 / 25 %	3,0
	11.0 kW	SK BRI4-3-023-600	275 272 800	23	600 / 25 %	6,0
3 ~ 400 V	0.55 ... 4.0 kW	SK BRI4-1-400-100	275 272 012	400	100 / 25 %	1,0
	5.5 ... 7.5 kW	SK BRI4-2-200-200	275 272 108	200	200 / 25 %	2,0
	11.0 ... 15.0 kW	SK BRI4-3-100-300	275 272 205	100	300 / 25 %	3,0
	18.5 ... 22.0 kW	SK BRI4-3-050-600	275 272 801	50	600 / 25 %	6,0

¹ Reduction of the continuous output of the braking resistor to 25% of the rated output

² Permissible max. once within 10 s

Braking resistors

External version

External braking resistors SK BRE4

External braking resistors (IP67) are intended for applications in which longer (lifting equipment), frequent (cyclic operation) or intensive (highly dynamic positioning applications) braking is to be expected. They are mounted directly on the frequency inverter. Typically, they can develop high surface temperatures (>70 °C), which exclude their use in an explosive atmosphere.

Note

The braking resistors listed here are designed for typical applications with occasional braking. In case of doubt or for applications with higher braking power (lifting equipment), we recommend specific planning of the necessary brake resistor. Please contact the NORD DRIVE-SYSTEMS Group directly..

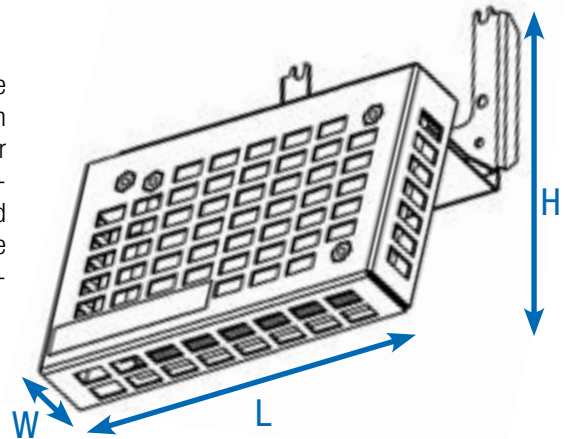

Frequency inverter SK 2xxE ...	Resistor type Material No.	Resistance [Ω]	Continuous output [W]	Power consumption ² [kW]	(Overall) dimensions L x W x H [mm]
1~115V 0.25 ... 0.75 kW	SK BRE4-1-100-100 275 273 005	100	100	2.2	150 x 61 x 178
	Alternatively: SK BRE4-2-100-200 275 273 105	100	200	4.4	255 x 61 x 178
1~230V 0.25 ... 1.1 kW	SK BRE4-1-100-100 275 273 005	100	100	2.2	150 x 61 x 178
	Alternatively: SK BRE4-2-100-200 275 273 105	100	200	4.4	255 x 61 x 178
3~230V 0.25 ... 2.2 kW 3.0 ... 4.0 kW 5.5 ... 11.0 kW	SK BRE4-1-200-100 275 273 008	200	100	2.2	150 x 61 x 178
	Alternatively: SK BRE4-2-200-200 275 273 108	200	200	4.4	255 x 61 x 178
	SK BRE4-2-100-200 275 273 105	100	200	4.4	255 x 61 x 178
	SK BRE4-3-050-450 275 273 201	50	450	3.0	355 x 245 x 318
3~400V 0.55 ... 4.0 kW 5.5 ... 7.5 kW 11.0 ... 22.0 kW	SK BRE4-1-400-100 275 273 012	400	100	2.2	150 x 61 x 178
	Alternatively: SK BRE4-2-200-200 275 273 108	200	200	4.4	255 x 61 x 178
	SK BRE4-2-200-200 275 273 108	200	200	4.4	255 x 61 x 178
	SK BRE4-3-100-450 275 273 205	100	450	3.0	355 x 245 x 318

¹ Permissible max. once within 120 s

Please find a full range of accessories below that can be equally used for different series. This primarily applies to our decentralised devices of the NORDAC *LINK*, NORDAC *ON*, NORDAC *FLEX*, NORDAC *BASE* and NORDAC *START* series.

Operation
and parameterisation

Seite 28



Interfaces
for communication

Page 30



24 V power supply units,
potentiometers, switches, signal converters
and more

Page 36



System connectors
for power and control connections

Page 40











Connection technology
Cables



Page 44



Operation and parameterisation

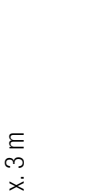

Control and parameterisation units /software

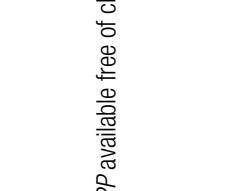
Designation Material No.	Description	Remarks
 <p>ParameterBox SK PAR-5H 275281614</p>	Control and parameterisation, LCD (illuminated), plain text display in 14 languages, direct control of up to five devices, memory for five device data sets, convenient control keypad, communication via RS-485, including 1.5 m connection cable. Handheld, suitable for installation in a control cabinet door. IP54	Connection for data exchange with <i>NORDCON STUDIO</i> to a PC (USB 2.0), (standard "USB-C" connection cable required, e.g. material number: 275292100) Power supply, e.g. directly via frequency inverter or PC
 <p>ParameterBox SK PAR-5A 275281714</p>	Suitable for control and parameterisation, LCD screen (illuminated), plain text display in 14 languages, direct control of up to 5 devices, memory for 5 device data sets, convenient control keypad, for mounting to a frequency inverter.	Power supply, e.g. directly via frequency inverter or PC Mounting to frequency inverter
 <p>SimpleControlBox SK CSX-3H 275281013</p>	Control and parameterisation, 4-digit, 7-segment display, direct control of a device, convenient control keypad, including 2 m connection cable Handheld, IP54	Electrical data: 4.5 ... 30 V DC / 1.3 W, supply e.g. directly via the frequency inverter
 <p>Control box SK POT1-1 278910120</p>	Potentiometer 0 ... 100% (0 ... 10 V), switch LeftIAUSIRight, including 3 m connection cable. Handheld, wall mounting, IP66	
 <p>Control box SK POT1-2 278910140</p>	Suitable for control, potentiometer 0 ... 100 % (0 ... 10 V), switch LeftIAUSIRight, including 20 m connection cable. Handheld, wall mounting, IP66	
 <p>SimpleSetpointBox SK SSX-3A 275281513</p>	Suitable for control and parameterisation, 4-digit, 7-segment display, direct control of a device, 3 operating modes, convenient control keypad. Handheld, wall mounting, IP54	Electrical data: 19.2 ... 28.8 V DC, 35 mA, supply e.g. directly via the frequency inverter, communication via RS-485 or IO link
 <p>SK TIE4-SSX-3A- 275274910</p>	Adapter for fitting the SK SSX-3A to the <i>NORDAC FLEX</i>	
 <p>Programming adapter SK EPG-3H 275281026</p>	Suitable for parameterisation of the external EEPROM (memory module) of an SK 2xxE, independent of the presence of a frequency inverter. Handheld, IP20	

Designation Material No.	Description	Remarks
 <p>Adapter cable RJ12-SUB-D9 278 910 240</p>	<p>To connect the frequency inverter to the serial interface of a PC via SUB-D9</p>	<p>Length: approx. 3 m</p>
<p>Connection set SK TIE4-RS232-USB 275 274 604</p>	<p>To connect the frequency inverter to the serial interface of a PC via USB 2.0</p>	<p>Consisting of adapter cable RJ12-SUB-D9 and RS-232 to USB inverter Length: approx. 3 m + 0.5 m</p>
 <p>Control and parameterisation software NORDCON</p>	<p>Software for control and parameterisation as well as commissioning assistance and fault analysis of NORD electronic drive technology. Parameter names in 14 languages</p>	<p>Free download: www.nord.com</p>
<p>NORDAC ACCESS BT Bluetooth-Stick SK TIE5-BT-STICK 275 900 120</p> 	<p>Interface for wireless connection to a mobile terminal device (e.g. tablet or smartphone) via Bluetooth. With the aid of the NORDCON APP, the NORDCON software for mobile terminal devices, enables smart operation and parameterisation as well as commissioning assistance and fault analysis of NORD electronic drive technology.</p>	<p>NORDCON APP available free of charge for Android and iOS</p>



Communication interfaces

Field bus extensions

Variant	Designation Material No.	Installation Attached / separate Protection class	Number of inputs / outputs	Description	Remarks
 PROFIBUS DP®	SK CU4-PBR 275 271 000	● ○ IP20	2 digital inputs	Interface as gateway for direct connection of up to four devices to a PROFIBUS DP® field bus. Digital signals can alternatively be connected via the front M12 round plug connector (only M12 modules)	Baud rate: maximum 12 MBd Protocol: DPV 0 and DPV 1 SK TU4 modules plus matching SK T14-TU- BUS / SK T14-TU-BUS-C connection unit
	SK CU4-PBR-C¹ 275 271 500	● ○ IP20			
	SK TU4-PBR 275 281 100	○ ● IP55			
	SK TU4-PBR-C 275 281 150	○ ● IP66	4 digital inputs		
	SK TU4-PBR-M12 275 281 200	○ ● IP55	2 digital outputs		
	SK TU4-PBR-M12-C 275 281 250	○ ● IP66			
 CANopen®	SK CU4-CAO 275 271 001	● ○ IP20	2 digital inputs	Interface as gateway for direct connection of up to four devices to a CANopen® field bus. Digital signals can alternatively be connected via the front M12 round plug connector (only M12 modules)	Baud rate: maximum 1 MBaud Protocol: DS 301 and DS 402 SK TU4 modules plus matching SK T14-TU- BUS / SK T14-TU-BUS-C connection unit
	SK CU4-CAO-C¹ 275 271 501	● ○ IP20			
	SK TU4-CAO 275 281 101	○ ● IP55			
	SK TU4-CAO-C 275 281 151	○ ● IP66	4 digital inputs		
	SK TU4-CAO-M12 275 281 201	○ ● IP55	2 digital outputs		
	SK TU4-CAO-M12-C 275 281 251	○ ● IP66			

¹ Version with varnished circuit boards for applications in IP6X devices

- Available as standard
- Not available











Variant	Designation Material No.	Installation Attached / separate	Protection class	Number of inputs / outputs	Description	Remarks
	SK CU4-DEV 275 271 002	●	○	IP20		
	SK CU4-DEV-C ¹ 275 271 502	●	○	IP20	2 digital inputs	
	SK TU4-DEV 275 281 102	○	●	IP55	Interface as gateway for direct connection of up to four devices to a DeviceNet [®] field bus. Digital signals can alternatively be connected via the front M12 round plug connector (only M12 modules)	Baud rate: maximum 500 kBaud Profile: AC-Drive and NORD-AC
	SK TU4-DEV-C 275 281 152	○	●	IP66		
	SK TU4-DEV-M12 275 281 202	○	●	IP55	2 digital outputs	SK TU4 modules plus matching SK T14-TU-BUS / SK T14-TU-BUS-C connection unit
	SK TU4-DEV-M12-C 275 281 252	○	●	IP66		

¹ Version with varnished circuit boards for applications in IP6X devices









- Available as standard
- Not available

Communication interfaces

Industrial Ethernet extensions

Variant	Designation Material No.	Installation Attached / separate	Protection Class	Number of inputs / out- puts	Description	Remarks
Industrial Ethernet	 SK CU4-ETH 275271027	●	○	IP20		
	 SK CU4-ETH-C 275271527	●	○	IP20	2 digital inputs	Interface as gateway for direct connection of up to four devices to the Industrial Ethernet. Parameterisation may be used with a choice between the following dialects: EtherCAT, EtherNet/IP, PROFINET IO
	 SK TU4-ETH 275281132	○	●	IP55		Baud rate: max. 100 Mbaud, EtherCAT: CoE, PROFINET IO: Conformance class B and C
	 SK TU4-ETH-C 275281182	○	●	IP66	8 digital inputs 2 digital outputs	Connection of the bus cable via the front RJ45 or M12 circular connectors (only TU4 modules).
	 SK TU4-ETH-M12 275281233	○	●	IP55		
	 SK TU4-ETH-M12-C 275281283	○	●	IP66		
PROFIsafe	 SK TU4-PNS 275281116	○	●	IP55		Baud rate: maximum 100 Mbaud, Conformance class B and C,
	 SK TU4-PNS-C 275281166	○	●	IP66	2 safe digital inputs(SI), 3 safe digital outputs(SO)	SK TU4 modules plus matching SK T14-TU4-SAFE / SK T14-TU4-SAFE-C connection unit
	 SK TU4-PNS-M12 275281216	○	●	IP55		
	 SK TU4-PNS-M12-C 275281266	○	●	IP66		



- Available as standard
- Not available

Variant	Designation Material No.	Installation	Attached / separate	Protection class	Number of inputs / out- puts	Description	Remarks
	SK CU4-ECT 275 271 017	●	○	IP20	2 digital inputs	Interface as gateway for direct connection of up to four devices to an EtherCAT® field bus. Connection of the bus cable via the front M12 round plug connector (only TU4 modules).	Baud rate: maximum 100 MBaud, CoE (CAN over EtherCAT®), SK CU4 module: Derating (see data sheet) SK TU4 modules plus matching SK T14-TU-BUS / SK T14-TU-BUS-C connection unit
	SK CU4-ECT-C¹ 275 271 517	●	○	IP20	2 digital inputs		
	SK TU4-ECT 275 281 117	○	●	IP55	8 digital inputs	Interface as gateway for direct connection of up to four devices to an EtherNet/IP® fieldbus. Connection of the bus cable via the front M12 round plug connector (only TU4 modules).	Baud rate: maximum 100 MBaud, SK CU4 module: Derating (see data sheet) SK TU4 modules plus matching SK T14-TU-BUS / SK T14-TU-BUS-C connection unit
	SK TU4-ECT-C 275 281 167	○	●	IP66	2 digital outputs		
	SK CU4-EIP 275 271 019	●	○	IP20	2 digital inputs	Interface as gateway for direct connection of up to four devices to an EtherNet/IP® fieldbus. Connection of the bus cable via the front M12 round plug connector (only TU4 modules).	Baud rate: maximum 100 MBaud, SK CU4 module: Derating (see data sheet) SK TU4 modules plus matching SK T14-TU-BUS / SK T14-TU-BUS-C connection unit
	SK CU4-EIP-C¹ 275 271 519	●	○	IP20	2 digital inputs		
	SK TU4-EIP 275 281 119	○	●	IP55	8 digital inputs	Interface as gateway for direct connection of up to four devices to a POWERLINK field bus. Connection of the bus cable via the front M12 round plug connector (only TU4 modules).	Baud rate: maximum 100 MBaud, SK CU4 module: Derating (see data sheet) SK TU4 modules plus matching SK T14-TU-BUS / SK T14-TU-BUS-C connection unit
	SK TU4-EIP-C 275 281 169	○	●	IP66	2 digital outputs		
	SK CU4-POL 275 271 018	●	○	IP20	2 digital inputs	Interface as gateway for direct connection of up to four devices to a POWERLINK field bus. Connection of the bus cable via the front M12 round plug connector (only TU4 modules).	Baud rate: maximum 100 MBaud, SK CU4 module: Derating (see data sheet) SK TU4 modules plus matching SK T14-TU-BUS / SK T14-TU-BUS-C connection unit
	SK CU4-POL-C¹ 275 271 518	●	○	IP20	2 digital inputs		
	SK TU4-POL 275 281 118	○	●	IP55	8 digital inputs	Interface as gateway for direct connection of up to four devices to a PROFINET IO® field bus. Connection of the bus cable via the front RJ45 or M12 round plug connector (only TU4 modules).	Baud rate: maximum 100 MBaud, SK CU4 module: Derating (see data sheet) SK TU4 modules plus matching SK T14-TU-BUS / SK T14-TU-BUS-C connection unit
	SK TU4-POL-C 275 281 168	○	●	IP66	2 digital outputs		
	SK CU4-PNT 275 271 015	●	○	IP20	2 digital inputs	Interface as gateway for direct connection of up to four devices to a PROFINET IO® field bus. Connection of the bus cable via the front RJ45 or M12 round plug connector (only TU4 modules).	Baud rate: maximum 100 MBaud, SK CU4 module: Derating (see data sheet) SK TU4 modules plus matching SK T14-TU-BUS / SK T14-TU-BUS-C connection unit
	SK CU4-PNT-C¹ 275 271 515	●	○	IP20	2 digital inputs		
	SK TU4-PNT 275 281 115	○	●	IP55	8 digital inputs	Interface as gateway for direct connection of up to four devices to a PROFINET IO® field bus. Connection of the bus cable via the front RJ45 or M12 round plug connector (only TU4 modules).	Baud rate: maximum 100 MBaud, SK CU4 module: Derating (see data sheet) SK TU4 modules plus matching SK T14-TU-BUS / SK T14-TU-BUS-C connection unit
	SK TU4-PNT-C 275 281 165	○	●	IP66	2 digital outputs		
	SK TU4-PNT-M12 275 281 122	○	●	IP55	8 digital inputs	Interface as gateway for direct connection of up to four devices to a PROFINET IO® field bus. Connection of the bus cable via the front RJ45 or M12 round plug connector (only TU4 modules).	Baud rate: maximum 100 MBaud, SK CU4 module: Derating (see data sheet) SK TU4 modules plus matching SK T14-TU-BUS / SK T14-TU-BUS-C connection unit
	SK TU4-PNT-M12-C 275 281 172	○	●	IP66	2 digital outputs		

¹ Version with varnished circuit boards for applications in IP6X devices

● Available as standard ○ Not available

Communication interfaces and connection units





Variant	Designation Material No.	Installation Attached / separate	Protection Class	Number of inputs / outputs	Description	Remarks
	SK CU4-IOE2 275 271 007	● ○	IP20	2 ² digital and 2 ³ analogue inputs,		Analogue signals: IN / OUT: 0(2) ... +10 V or 0(4) ... 20 mA
	SK CU4-IOE2-C ¹ 275 271 507	● ○	IP20	2 analogue outputs		
	SK CU4-IOE 275 271 006	● ○	IP20	2 digital and 2 ³ analogue inputs,	Sensor and actuator signal processing, connection via terminal bar Alternative connection of digital signals via front M12 round plug connector (only M12 modules)	Analogue signals: IN: -10 V ... +10 V or 0(4) ... 20 mA OUT: 0(2) ... +10 V or 0(4) ... 20 mA SK TU4 modules plus matching SK T14-TU-BUS / SK T14-TU-BUS-C connection unit
	SK CU4-IOE-C ¹ 275 271 506	● ○	IP20	1 analogue output		
	SK TU4-IOE 275 281 106	○ ●	IP55	4 digital and 2 analogue inputs,		
	SK TU4-IOE-C 275 281 156	○ ●	IP66	2 digital and 1 analogue output		
	SK TU4-IOE-M12 275 281 206	○ ●	IP55			
	SK TU4-IOE-M12-C 275 281 256	○ ●	IP66			

¹ Version with varnished circuit boards for applications in IP6X devices

² Digital inputs can optionally be used as digital inputs or outputs

³ Analogue inputs can optionally be used as analogue or digital inputs

- Available as standard
- Not available

Variant	Designation Material No.	Installation / separate Protection class	Description
	SK T14-TU-BUS 275 280 000	<input type="radio"/> IP55	Connection unit for SK TU4-.... bus interfaces or IO - extensions (IP55), including RS-232 diagnostic interface (RJ12 port)
	SK T14-TU-BUS-C 275 280 500	<input type="radio"/> IP66	Connection unit for SK TU4-.... bus interfaces or IO - extensions (IP66), including RS-232 diagnostic interface (RJ12 port)
	SK T14-TU-SAFE 275 280 300	<input type="radio"/> IP55	Connection unit for safe bus interface SK TU4-PNS-.... (IP55), including RS-232 diagnostic interface (RJ12 port)
	SK T14-TU-SAFE-C 275 280 800	<input type="radio"/> IP66	Connection unit for safe bus interface SK TU4-PNS-....-C (IP66), including RS-232 diagnostic interface (RJ12 port)
	SK TIE4-WMK-TU 275 274 002	<input type="radio"/> IP66	For separate mounting of SK TU4... modules with SK T14-TU-...

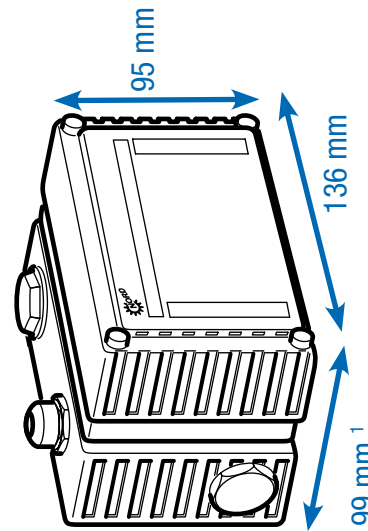

- Available as standard
- Not available



¹ Depth varies for versions with connections on the front side.

Supply and control



24 V power supply units, potentiometer and switches

Variant	Designation Material No.	Installation Attached / separate	Protection class	Description	Remarks
	SK CU4-24V-123-B 275 271 108	● ○	IP20	Output: 24 V DC, 420 mA	For connection to 115 V/230 V devices, including AD converter for evaluation of a 10 k Ω - potentiometer
	SK CU4-24V-123-B-C ¹ 275 271 608	● ○	IP20	Output: 24 V DC, 420 mA	
	SK CU4-24V-140-B 275 271 109	● ○	IP20	Output: 24 V DC, 420 mA	For connection to 400 V/500 V devices, including AD converter for evaluation of a 10 k Ω - potentiometer
	SK CU4-24V-140-B-C ¹ 275 271 609	● ○	IP20	Output: 24 V DC, 420 mA	
	SK TU4-24V-123-B 275 281 108	○ ●	IP55	Output: 24 V DC, 420 mA	For connection to 115 V/230 V devices, including AD converter for evaluation of a 10 k Ω - potentiometer
	SK TU4-24V-123-B-C 275 281 158	○ ●	IP66	Output: 24 V DC, 420 mA	plus suitable connection unit SK TI4-TU-NET/SK TI4-TU-NET-C
	SK TU4-24V-140-B 275 281 109	○ ●	IP55	Output: 24 V DC, 420 mA	For connection to 400 V/500 V devices, including AD converter for evaluation of a 10 k Ω potentiometer
	SK TU4-24V-140-B- 275 281 159	○ ●	IP66	Output: 24 V DC, 420 mA	plus suitable connection unit SK TI4-TU-NET/SK TI4-TU-NET-C

Power supplies

¹ Version with varnished circuit boards for applications in IP6X devices















- Available as standard
- Not available

Variant	Designation Material No.	Installation	Attached / separate Protection Class	Description	Remarks
Power supplies with control unit	 SK TU4-POT-123-B 275 281 110	<input type="radio"/>	● IP55	Output: 24 V DC, 420 mA	For connection to 115 V / 230 V devices, including setpoint adjuster 0% ... 100% and keys "ON R" - "OFF" - "ON L" plus suitable SK T14-TU-NET/SK T14-TU-NET-C connection unit
		<input type="radio"/>	● IP66	Output: 24 V DC, 420 mA	
	SK TU4-POT-140-B 275 281 111	<input type="radio"/>	● IP55	Output: 24 V DC, 420 mA	For connection to 400 V / 500 V devices, including setpoint adjuster 0% ... 100% and keys "ON R" - "OFF" - "ON L" plus suitable SK T14-TU-NET/SK T14-TU-NET-C connection unit
		<input type="radio"/>	● IP66	Output: 24 V DC, 420 mA	
Connection units	 SK T14-TU-NET 275 280 100	<input type="radio"/>	● IP55	SK TU4-... connection unit for power supply units (IP55)	
		<input type="radio"/>	● IP66	SK TU4-... connection unit for power supply units (IP66)	
	 SK TIE4-WMK-TU 275 274 002	<input type="radio"/>	○ IP66	For separate mounting of SK TU4... modules with SK T14-TU-...	

- Available as standard
- Not available

Supply and control

Signal converters and more

Variant	Designation Material No.	Installation Attached / separate Protection Class	Description	Remarks
Control elements	 SK CU4-POT 275 271 207	○ ● IP66	Switches and potentiometers	Switches: "ON R" - "OFF" - "ON L", 10 - kΩ potentiometer
	 SK TIE4-SWT 275 274 701	○ ● IP66	Switch	"ON R" - "OFF" - "ON L"
	 SK TIE4-POT 275 274 700	○ ● IP66	Potentiometer	10 kΩ potentiometer
	 SK ATX-POT 275 142 000	○ ● IP66	Potentiometer	10 kΩ - potentiometer, approved for use in ATEX Zone 22 3D
Signal converter and relay	 SK CU4-REL 275 271 011	● ○ IP20	2x AIN / AOUT, 2 DIN / relay	Converter for analogue signals -10 ... +10 V to 0 ... 10 V, 2 x changeover relay outputs 1 A (≤ 30 V), controlled via a digital input
	 SK CU4-REL-C' 275 271 511	● ○ IP20		
	 SK CU4-REL-POW 275 271 012	● ○ IP20	2x AIN / AOUT, 2 DIN / relay	Converter for analogue signals -10 ... +10 V to 0 ... 10 V, 2 x changeover relay outputs 8 A (≤ 30 V), controlled via a digital input
	 SK CU4-REL-POW-C' 275 271 512	● ○ IP20		
	 SK CU4-MBR 275 271 010	● ○ IP20	230 V / 400 V, max. 0.5 A	For direct control and supply of an electromagnetic holding brake
	 SK CU4-MBR-C' 275 271 510	● ○ IP20		
	 SK CU4-SSR 275 271 124	● ○ IP20	2x DIN / relay	Relay outputs (NO), suitable for AC / DC (max. 277 V AC, 850 mA / 24 V DC +/- 25%, 850 mA), control either synchronously via a digital input or individually via one digital input each
	 SK CU4-SSR-C' 275 271 624	● ○ IP20		
	 SK CU4-SSR-400 275 271 128	● ○ IP20	2x DIN / relay	Relay outputs (NO), suitable for AC (480 V AC +10%, max. 300 mA), control either synchronously via a digital input or individually via one digital input each
	 SK CU4-SSR-400-C' 275 271 628	● ○ IP20		

¹ Version with varnished circuit boards for applications in IP6X devices

- Available as standard
- Not available

Variant	Designation Material No.	Installation Attached / separate Protection class	Description	Remarks
Residual voltage discharge	SK CU4-PD1 275 271 025	● ○ IP20	Module for residual voltage dissipation	Load resistance 3 x 470 kOhm, ≤ 550 V AC/DC, ≤ 20 A
	SK CU4-PD1-C1 275 271 525	● ○ IP20		
Switch	SK TU4-MSW 275 281 123	○ ● IP55	1 ~ 100 - 240 V / 3 ~ 200 - 500 V, 16 A	Switch to disconnect the device from the power supply, black twist grip plus suitable SK T14-TU-MSW/SK T14-TU-MSW-C connection unit
	SK TU4-MSW-C 275 281 173	○ ● IP66	1 ~ 100 - 240 V / 3 ~ 200 - 500 V, 16 A	
Connection units	SK T14-TU-MSW 275 280 200	○ ● IP55		SK TU4-... connection unit for maintenance switches (IP55)
	SK T14-TU-MSW-C 275 280 700	○ ● IP66		SK TU4-... connection unit for maintenance switches (IP66)
	SK TIE4-WMK-TU 275 274 002	○ ○ IP66		For separate mounting of SK TU4... modules with SK T14-TU-...

¹ Version with varnished circuit boards for applications in IP6X devices

- Available as standard
- Not available

Perfect connections with system plug connectors

The use of optionally available plug connectors for power and control connections not only makes it possible to replace the drive unit with almost no loss of time in case of servicing, but also minimises the danger of installation errors when connecting the device. This enables the perfect construction of an energy or communication bus. Typical plug connector versions are summarised below.



Plug connectors for power connections

Plug connectors from various manufacturers are available for the motor or mains connection for rated currents of up to 20A.

Type	Data	Designation	Material No.
Input (power and control voltage)	400 V, 16 A + 24 V, 4 A	SK TIE4-HANQ4-M-LE-MX	275 274 113
Input (power and control voltage)	400 V, 16 A + 24 V, 10 A	SK TIE4-NQ16-K-LE	275 274 133
Input and output (power and control voltage)	400 V, 32 A + 24 V, 4 A	SK TIE4-2HANQ4-M-LE-LA	275 274 112
Input and output (power and control voltage)	400 V, 40 A + 24 V, 6 A	SK TIE4-2HANQ4-M-LE-LA-6mm	275 274 119
Power input	500 V, 16 A	SK TIE4-HAN10E-M1B-LE	275 135 070
Power input	500 V, 16 A	SK TIE4-HAN10E-M2B-LE	275 135 000
Power input	500 V, 16 A	SK TIE4-HANQ8-M-LE-MX	275 135 030
Power input	690 V, 20 A	SK TIE4-QPD4SPM	275 274 185
Power output	500 V, 16 A	SK TIE4-HAN10E-M2B-LA	275 135 010
Power output	500 V, 16 A	SK TIE4-HANQ8-M-LA-MX	275 135 040
Motor output	500 V, 16 A	SK TIE4-HAN10E-M2B-MA	275 135 020
Motor output	500 V, 16 A	SK TIE4-HANQ8-M-MA-MX	275 135 050
Power input + motor or power output	400 V, 16 A	SK TIE4-2HANQ5-K-LE-LA	275 274 110



Plug connectors for control connections

Various M12 round plug connectors are available as flanged plugs or flanged sockets. The plug connectors are intended for installation in an M16 screw fitting on the device and can be oriented in any direction. The protection class (IP67) of the plug connector only applies in the screwed state. The cover caps correspond to the colour version as does the plastic body of the plug connector. Expansion and reducer adapters are available for installation in an M12 or M20 screw fitting.



Type	Version	Designation	Material No.
System bus IN	Plug connectors	SK TIE4-M12-SYSS	275 274 506
System bus OUT	Bushing	SK TIE4-M12-SYSM	275 274 505
Power supply	Plug connectors	SK TIE4-M12-POW	275 274 507
Sensors/actuators	Bushing	SK TIE4-M12-INI	275 274 503
Sensors/actuators	Plug connectors	SK TIE4-M12-INP	275 274 516
Analogue signal	Bushing	SK TIE4-M12-ANA	275 274 508
HTL encoder	Bushing	SK TIE4-M12-HTL	275 274 512
Safe stop	Plug connectors	SK TIE4-M12-SH-IN	275 274 519
Safe stop	Bushing	SK TIE4-M12-SH	275 274 509
AS-Interface	Plug connectors	SK TIE4-M12-ASI	275 274 502
AS-Interface – Aux	Plug connectors	SK TIE4-M12-ASI-AUX	275 274 513
CANopen® / DeviceNet® IN	Plug connectors	SK TIE4-M12-CAO	275 274 501
CANopen® / DeviceNet® OUT	Bushing	SK TIE4-M12-CAO-OUT	275 274 515
Ethernet	Bushing	SK TIE4-M12-ETH	275 274 514
PROFIBUS® (IN + OUT)	Connector + socket	SK TIE4-M12-PBR	275 274 500
Connection extension	M12 - M16	SK TIE4-M12-M16	275 274 510
Connection reduction	M20 – M16	SK TIE4-M20-M16	275 274 511



Installation locations for system connectors

System connectors

The devices provide various screw fittings which can be used for the installation of cable glands or system connectors. Screw-in reduction or expansion adapters enable the connection of additional cable cross sections as required.

NORDAC FLEX (SK T14-...)

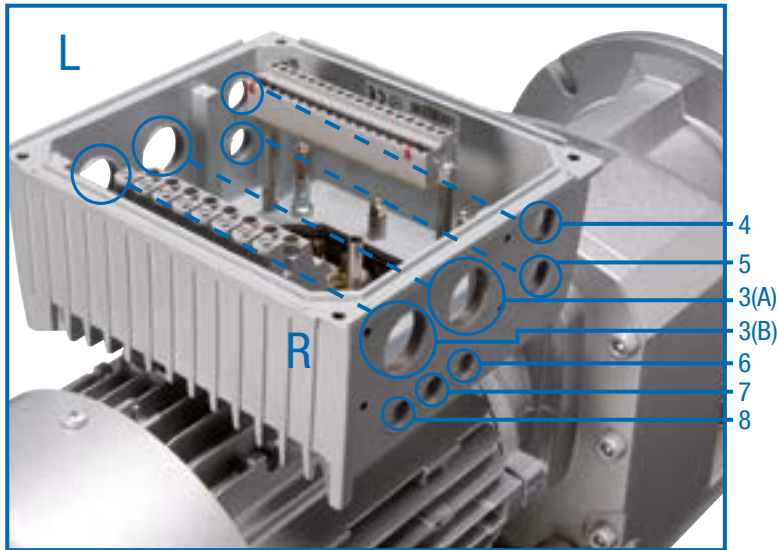

Option locations (R or L assignment, view towards the motor fan)

- 3 L/R 2 x M25 screw fitting (A/B)
- 4 L/R M16 screw fitting
- 5 L/R M16 screw fitting
- 6 L/R M12 screw fitting, BG 4 → M16
- 7 L/R M12 screw fitting, BG 4 → M16
- 8 L/R M12 screw fitting, BG 4 → M16

Size 4 Additional screw fitting L/R: M32

The plug connectors for the power connection are installed at position 3 (R or L).

Connection unit - Technology Unit

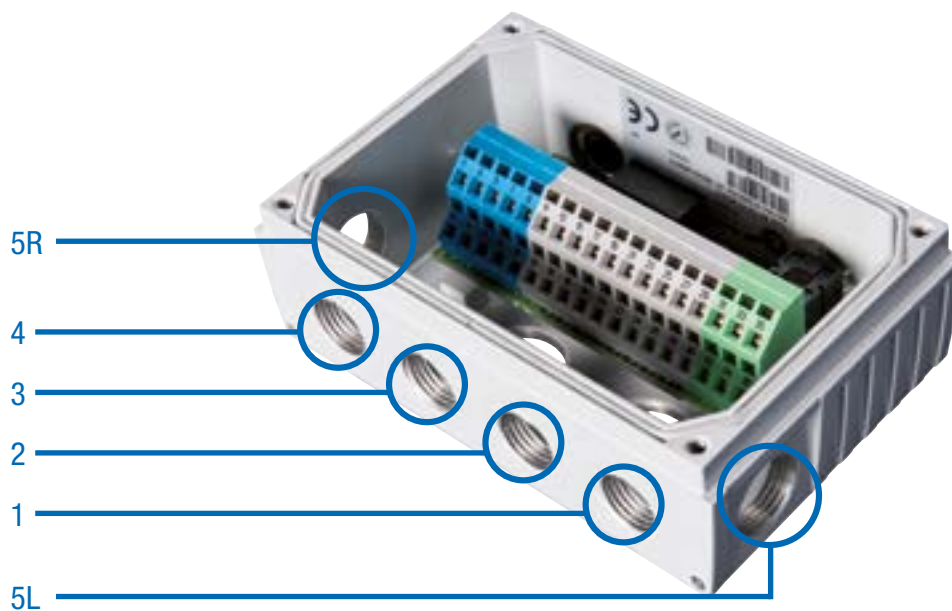

Optionsplätze der SK TI4-TU-...

- 1 M16 screw fitting
- 2 M16 screw fitting
- 3 M16 screw fitting
- 4 M16 screw fitting
- 5 L/R M20 screw fitting



Not to be underestimated – the correct connection method

With the NORDAC *LINK*, *FLEX*, *BASE* and *START* frequency inverters and motor starters, the NORD DRIVESYSTEMS Group provides the right product for motor control for all decentralised drive technology applications. The advantages, such as short motor cables, improved EMC and installation without control cabinets are obvious.

Connection of the decentralised components (motor and electronics) is made either with a permanent connection with cable glands¹ or can be in the form of plug connectors. However, the full advantages of decentralised drive technology are only achieved with the selection of plug-in connectors.

- ▶ Quick and simple electrical connection
- ▶ Minimisation of connection errors
- ▶ Minimum installation effort for installation, maintenance and servicing
- ▶ Reduced downtime in case of replacement

NORD supplies an extensive range of connection and control cables.

- ▶ Depending on the version, connecting cables include power connection cables (mains and motor) and if necessary cables for thermistors as well as 24 V DC control voltage.
- ▶ Control cables are exclusively used for transmitting control signals (encoder, bus, IO signals).

Connection and control cables are supplied pre-assembled. They are available in various lengths and can optionally be provided with open ends or plug connectors. Typically, all cables² are shielded.

¹ Not for NORDAC *LINK*, NORDAC *ON*

² Except for mains connection/daisy chain cables



Designation of pre-assembled cables

Pre-assembled cables

- ▶ Cables for motor and frequency inverter connection
- ▶ Mains connection and signal cables
- ▶ Customised plug connectors and cable lengths

SC H4G2.5 HQ8SMM H10E1SMF 1.5 UL

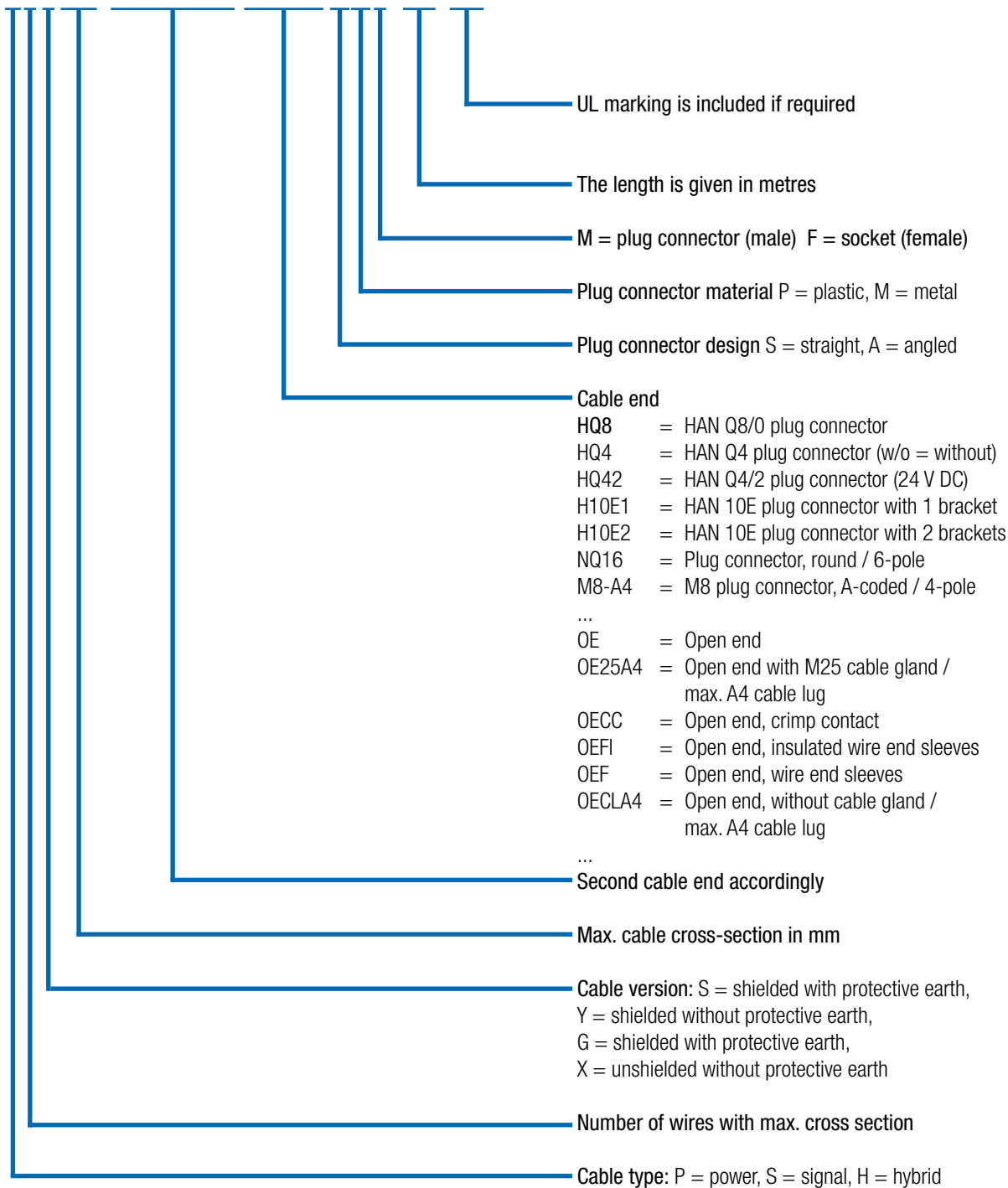

Technical data

cables

The design depends on the ambient conditions and the type of installation and must be decided by the customer. All options can be requested from NORD according to the specific project.

Feature	Standard	Options
Conductor material	Copper	-
Installation type	Permanent installation	-
Cable insulation	Polyvinyl chloride (PVC)	Polyurethane (PUR)
Protective sleeve	No	On request
Cable length	Motor cables: 1.5 m – 3.0 m – 5.0 m Mains cables: 1.5 m – 3.0 m – 5.0 m Daisy chain cables: 1.5 m – 3.0 m – 5.0 m Encoder cables: 1.5 m – 3.0 m – 5.0 m Brake resistor cables: 2.0 m – 3.0 m	On request

Motor cables

Product overview – Motor cables

Depending on the motor, the following shielded motor connection cables are available.

NORDAC LINK, FLEX, BASE, START

Designation	Motor power [kW]	Certification	Part number for length [m]		
			1.5	3	5
SC H4S2.5 HQ8SPM OE20A4 UL	0,12 - 0,37	EU / UL	275 274 800	275 274 801	275 274 802
SC H4S2.5 HQ8SPM OE25A4 UL	0,55 - 1,5	EU / UL	275 274 805	275 274 806	275 274 807
SC H4S2.5 HQ8SPM OE32A4 UL	2,2 - 3,0	EU / UL	275 274 825	275 274 826	275 274 827
SC H4S2.5 HQ8SPM OE32A5 UL	4,0	EU / UL	275 274 830	275 274 831	275 274 832
SC H4S4 HQ8SPM OE32A6 UL	5,5 - 9,2	EU / UL	275 274 835	275 274 836	275 274 837
SC H4S2.5 HQ8SPM H10E1SMF	0,12 - 4,0	EU	275 274 810	275 274 811	275 274 812

NORDAC ON

Designation	Motor power [kW]	Certification	Part number for length [m]		
			1.5	3	5
SC H4S1 ST8SMM OE20A4 UL	63 – 71 IE1 - IE3	EU / UL	275 274 690	275 274 691	275 274 692
SC H4S1 ST8SMM OE20A4 UL WOB ¹	63 – 71 IE1 - IE3	EU / UL	275 274 617	275 274 618	275 274 619
SC H4S1 ST8SMM OE25A4 UL	80 – 90 IE1 - IE3 71 IE5+	EU / UL	275 274 695	275 274 696	275 274 697
SC H4S1 ST8SMM OE25A4 UL WOB ¹	80 – 90 IE1 - IE3 71 IE5+	EU / UL	275 274 621	275 274 622	275 274 623
SC H4S1 ST8SMM HQ8SMF UL	NORD Motorstecker „MS21“	EU / UL	275 274 685	275 274 686	275 274 687
SC H4S1.5 TEH51SVM TEH51SVF MBE ²		EU / UL	in preparation	in preparation	in preparation

Frequency inverter/Motor starter connection

Motor connection

Required motor option¹



Open ends

ZKK



MS31 or MS31E

¹For further information about motor options please refer to motor catalogue M7000

Mains cables / Daisy chain cables

Product overview – Mains cable

The following unshielded mains cables are available. A simple plug-in connection for frequency inverters can be achieved with the HQ4 variant. With a further variant (HQ42) a 24 V DC supply can also be implemented.

Designation	24 V DC supply	Certification	Part number for length [m]		
			1.5	3	5
SC P4G2.5 HQ4SPF OE	no	EU	275 274 840	275 274 841	275 274 842
SC P4GA14 HQ4SPF OE UL	no	UL		275 274 241	275 274 242
SC H4G4 HQ42SPF OE	yes	EU	275 274 845	275 274 846	275 274 847
SC H4GA12 HQ42SPF OE UL	yes	UL		275 274 246	275 274 247
SC H6G2.5 NQ16SPF OE UL ¹	yes	UL	275 274 218	275 274 219	275 274 220

¹ only NORDAC *ON*



Product overview – Daisy chain cables

A daisy chain cable is designed for looping the mains connection (plug connections on both sides) from one frequency inverter to the next. The variants as for mains cables are available. These cables are also unshielded.

Designation	24 V DC supply	Certification	Part number for length [m]		
			1.5	3	5
SC P4G4 HQ4SPM HQ4SPF	no	EU	275 274 850	275 274 851	275 274 852
SC P4GA12 HQ4SPM HQ4SPF UL	no	UL		275 274 251	275 274 252
SC H4G4 HQ42SPM HQ42SPF	yes	EU	275 274 855	275 274 856	275 274 857
SC H4GA12 HQ42SPM HQ42SPF UL	yes	UL		275 274 256	275 274 257
SC H6G2.5 NQ16SPM NQ16SPF UL ¹	yes	UL	275 274 288	275 274 289	275 274 290

¹ only NORDAC *ON*



Brake resistor cable / Control cables

Product overview – Braking resistor cables

The following shielded cables are available for connecting an external brake resistor

Designation	Certification	Part number for length [m]	
		2	3
SC P3S2.5 HQ2SPM OE	EU	275 274 881	275 274 899
SC P3SA14 HQ2SPM OE UL	UL	275 274 280	275 274 281



Product overview – Control cables

Control cables for connection to an encoder are typically connected with so-called "M12 plug connectors". The following system solutions are available for encoder connection.

Designation	Motors			Encoders ¹	Cable type	Control cable Length - Part No.
	IE1-3	IE4	IE5+			
AG4 cable set consisting of 1x each SK CE-A5F-AGC-A5F SK CE-B4M-IGC-B5F	●	●	○	AG4 - 19 551 886	AG4 cable set	1.5 m - 275 274 640 3.0 m - 275 274 641 5.0 m - 275 274 642
SC S4Y0.25 M12-B4MM M12-A8SMF	●	○	○	IG12P - 19 651 501 IG22P - 19 651 511 IG42P - 19 651 521	HTL without zero track	1.5 m - 275 274 675 3.0 m - 275 274 676 5.0 m - 275 274 677
SC S5S0.25 M12-A5SPM M12-A5SPF	○	●	○	IG22P5 - 19 651 910	HTL with zero track	1.5 m - 275 274 874 3.0 m - 275 274 876 5.0 m - 275 274 877
	○	○	●	IG62P5 - 19 605 002		
SC S5Y0.25 M12-A5SMM M12-A8SMF	○	●	○	IG22P8 - 19 651 911	HTL with zero track	1.5 m - 275 274 645 3.0 m - 275 274 646 5.0 m - 275 274 647

- Available as standard
- Not available

¹ Further information about encoders can be obtained from motor catalogue M7000.

Headquarters:

Getriebebau NORD GmbH & Co. KG

Getriebebau-Nord-Str. 1

22941 Bargteheide, Deutschland

T: +49 (0) 45 32 / 289 - 0

F: +49 (0) 45 32 / 289 - 22 53

info@nord.com