

GETRIEBEBAU NORD

Member of the NORD DRIVESYSTEMS Group

Getriebebau NORD GmbH & Co. KG

Getriebebau-Nord-Straße 1 • 22941 Bargteheide, Germany • www.nord.com



SK TU4-PNS-M12

Part number: 275 281 216

PROFIsafe® – Bus interface

The bus interface may only be installed and commissioned by qualified electricians. An electrician is a person who, because of their technical training and experience, has sufficient knowledge with regard to

- Switching on, switching off, isolating, earthing and marking power circuits and devices,
- Proper maintenance and use of protective devices in accordance with defined safety standards.



Danger of electric shock

The frequency inverter carries hazardous voltage for up to 5 minutes after being switched off.

- Work must not be carried out unless the frequency inverter has been disconnected from the voltage and at least 5 minutes has elapsed since the mains was switched off.

Validity of document

This document is only valid in conjunction with the operating instructions of the respective frequency inverter and the bus communication manual for this bus interface (📖 See overview at end of document). These documents contain all of the information that is required for safe commissioning of the bus interface module and the frequency inverter.

Scope of delivery

1 x	Bus interface	SK TU4-PNS-M12
4 x	Hexagonal socket screw	M4 x 40 mm
Required accessories:		
1 x	Bus connection unit TI 275280300	SK TI4-TU-SAFE (Part no.: 275280300)



Technical Information / Datasheet		SK TU4-PNS-M12			
PROFIsafe bus interface		TI 275281216	V 1.5	2523	en

Field of use

External technology unit for connecting a decentralised frequency inverter (NORDAC FLEX) to a **PROFIsafe** field bus. The bus interface can be mounted on or in the immediate vicinity of the frequency inverter. It is connected to the frequency inverter via the system bus.

The bus interface can directly control up to four frequency inverters via PROFINET IO based on the system bus.

Two secure digital inputs, two clock outputs and three secure digital outputs are available. Therefore a maximum of three frequency inverters (devices with safe inputs) can be directly controlled via the safe outputs of the bus interface.

The connection of a safety SIN/COS encoder is possible and a prerequisite for the use of the safety functions SSM, SLS, SSR, SDI and SOS

Technical Data

Applied standards

"Functional safety" standards	EMC standards
EN ISO 13849-1	EN 61326-1: 2013 ¹⁾
EN 62061	EN 61326-3-1: 2008
EN 61508 Part 1-7	

¹⁾ With regard to resistance from interference due to electromagnetic fields, in the range of 80 MHz to 1 GHz, the module is only suitable for the basic electromagnetic environment. The safety criterion according to EN 61326-3-1 is not affected.

Bus interface

Temperature range	-25 °C...40 °C
Temperature class	Class 3k3
Supply voltage	24 V + 25 % / - 20 %, ≈ 140 mA reverse polarity protected

Vibration resistance	3M7
Protection class	IP55
Dimensions [mm] ¹⁾	H x W x D: 95 x 136 x 99

¹⁾

- Bus interface fitted to bus connection unit
- Depth: 108 mm with cover caps at M12 connection

Safety key figures

 **WARNING**
Loss of safe function

- An external cross circuit between + 24 V and a safe output (SO) results in the module being switched off with an error message to the fail-safe control. The applied 24 V cross circuit is, however, not switched off!

If an exclusion of errors by means of safe wiring is not possible, both the safe input as well as the safe output can be connected with two channels. Double channel operation must be set by parameterisation.

It is essential to observe the following safety key figures in order to achieve the required safety level for your machine/system.

The operating mode corresponds to "high demand" according to IEC 61508.

Unit	Operating mode	EN 61508-6 PFH ¹⁾ [1/h]	ISO 13849-1 PL	ISO 13849-1 Category	EN 61508-6 SIL	EN 13849-1 TM ²⁾ [years]
CPU/logic	-	0.7×10^{-9}	PL e	Cat. 4	SIL 3	20
Inputs						
SI inputs	1-channel	0.1×10^{-9}	PL d	Cat. 2	SIL 2	20
SI inputs	2-channel	0.01×10^{-9}	PL e	Cat. 4	SIL 3	20
Sin/Cos encoder		9.8×10^{-9}	PL e	Cat. 3	SIL 3 ³⁾	20
Outputs						
SO outputs	1-channel ⁴⁾	0.7×10^{-9}	PL e	Cat. 3	SIL 3	20
SO outputs	2-channel	0.06×10^{-9}	PL e	Cat. 4	SIL 3	20

1) **PFH** Probability of a hazardous failure

2) **TM** Operational life

3) **Sin/Cos encoder:** Due to the system, only SIL2 is achieved for the positioning and detection of the direction of rotation (SOS, SDI).

4) **SO output:** A proof test may need to be performed for the "single channel output" (see [BU 2800](#)).

An exclusion of errors must be performed according to ISO 13849-2 (2013) when wiring a single channel output.

 **Information**

All units used in a safety function (inputs, logic, outputs) must be considered during the calculation of the safety specific values.

Bus specification

PROFIsafe	max. 100 MBaud
	electrical isolation 500 V _{eff}
Bus connection	2 x M12
Bus termination	carried out automatically
Status display	6 LED
Topology	Star, tree, ring, line

Cable	min. Ethernet CAT-5
max. cable length	100 m between two bus interfaces
Shield	See Shielding information
PE port	Via PE screw terminal in connection box

Information

Wiring / Shielding

The wiring between the bus module and the frequency inverter must comply with the section "**Exclusion of wiring errors**" in the **Functional Safety** section of the manual for the particular frequency inverter ([BU 0230](#) / [BU 0235](#) / [BU 0530](#)).

The PE is connected to the various circuit board levels via the screw fastenings of the circuit boards.

- Shielding of the bus cable is connected directly to PE via the M12 connection.
- Shielding of the IOs must be connected to the PE connection (PE screw terminal in the connection box).
- A separate cable with its own shielding must be used for the digital outputs.

Power

Update interval for process data between bus interface and frequency inverter	≥ 5 ms
Parameter read access to frequency inverter	≈ 15 ms
Parameter write access with saving in EEPROM	≈ 25 ms
Cycle times	≥ 1 ms

Additional information for SAFE

Topic	Specification	Unit	Min.	Typical	Max.
Voltage supply	Voltage supply to the module via a safely isolated power supply unit (SELV or PELV). • Fuse protection required (fuse (8 A))	[V]	19.2	24	30
	• 24 V consumption of SK TU4-PNS-M12 when idle	[mA]		140	
	• Additional requirement for digital outputs and clock outputs (for details, also refer to “Digital outputs”) • Additional requirement for SIN/COS encoder supply (depends on manufacturer)				1000 150
Digital outputs	Low Signal output voltage	[V]		0	0.8
	High Signal output voltage	[V]	17	24	30
	Output current (OSSD 1...3) ^{1, 2)} peak	[mA]			300 500
	T _{OSSD} = Test pulse cycle	[ms]	50	50	50
	t _{OSSDoff} = Pulse length (variable in 200 µs steps)	[ms]	0.3	0.5	2.0
	t _{OSSDon} = Pulse pause (t _{OSSDoff} x 2)	[ms]	0.8	1.2	4.0
	t _{OSSDerror} = Detection of an OSSD error t _{OSSDerror} = T _{OSSD} x 3	[ms]	100	-	150
Digit inputs	Low Signal input voltage	[V]	-3	0	5
	High Signal input voltage	[V]	15	24	30
	High Signal input current	[mA]			6
	Reaction time	[ms]			30
	T _{OSSD} = Test pulse cycle (contact test)	[ms]	50		
	t _{Testoff} = Pulse length	[ms]	0.3	0.5	2.0
	Switch-on delay	[ms]	0	0	100
Clock outputs	Low Signal output voltage	[V]		0	0.8
	High Signal output voltage	[V]	17	24	30
	Output current	[mA]			50
	T _{Takt} = Test pulse cycle	[ms]	50		
	t _{Takt} = Pulse length	[ms]			2.0
Encoder	Voltage supply	[V]	19.2	24	30
	Input voltage (sin/cos)	[V]	2.25		2.75
	Maximum encoder frequency	[kHz]			150
Temperatures	Ambient temperature	[°C]	-25		40
	Bearing temperature	[°C]	-25		85
Protection class	Dust-tight and protected against (strong) water jets	IP	55	55	66

1 A maximum of 1 A can be provided for the three OSSD outputs and two clock outputs. The typical power for the STO control of the NORDAC FLEX is 125 mA (see [BU 0230](#)) (average value). This leaves a total of 875 mA for the remaining outputs. The respective limits of the outputs (300 mA for OSSD and 50 mA per clock output) must be taken into account.

The average values of the current loads of the STO controls are considered here. Short-term peak loads with STO control (500 mA, see [BU 0230](#)) are neither affected by the limit of the individual OSSD output (300 mA) nor by the max. current sum 1 A. Thus, a maximum of three STO controls can be operated by three different inverters with one module.

2 If the NORDAC FLEX with STO is used, the SO3 / OSSD3 will always be used for the STO.

Bus interface characteristics

Communication	RT (Real Time) → Real time communication of process data
	IRT (Isochronous Real Time) → Isochronous real time communication of synchronised process data
Addressing PROFINET IO	Automatic address assignment via IO controller using DCP (Discovery Configuration Protocol)
Data transfer	via Switched Ethernet
Autonegotiation	Negotiation of transfer parameters
Autocrossover	Transmission and receiver cables are automatically crossed in the switch as necessary
Conformity classes	CC-B and CC-C
Access for NORD diagnosis tool via	<ul style="list-style-type: none"> • Diagnostics socket on the device (if available) and via frequency inverter • Ethernet protocols UDP or TCP/IP possible

Safety communication	Monitoring of process data, sequential numbering of PROFIsafe telegrams (24-bit counter) and checksum test (CRC)
Network class	Netload Class I
PROFIsafe addressing	F address via DIP – switches, or as of SW version V1.5 also via parameters.

Installation

The bus interface must be attached to a suitable connection unit (SK TI4-TU...) and connected using the 4 provided M4 x 40 mm hexagon socket collar screws (Tightening torque 2 Nm). Installation details can be found in the data sheet for the relevant connection units.

Connections

The two Ethernet lines are connected exclusively via the two M12 sockets on the front. If the bus interface is the final subscriber on the line, one M12 socket can remain unoccupied. The use of EMC cable glands is recommended.

PIN	Signal	Description
1	TX+	Transmission Data +
2	RX+	Receive Data +
3	TX-	Transmission Data -
4	RX-	Receive Data -

PIN assignment
M12-4 socket
("D"- coded)

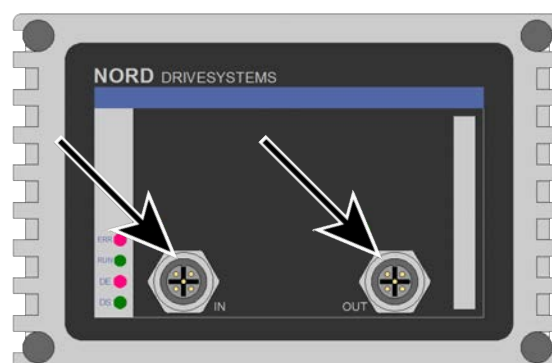

Connection of the other signal and control cables is made via the Bus: connection unit **SK TI4-TU-SAFE(-C)**

Terminals	Double spring-loaded terminal bar	2 x 18 contacts
Cable cross section	AWG 14-26	rigid: 0.14 ... 2.5 mm flexible: 0.14 ... 1.5 mm with wire end sleeves
PE connection	via housing	
RJ12	RJ12 socket	Interface for connecting parametrisation tool

Area	Contact	Designation	Description
1	Encoders	1	A Out Track A for external processing – 24V square wave signal
		2	B Out Track B for external processing – 24V square wave signal
		3	A+ Differential SIN signal +
		4	B+ Differential COS signal +
		5	A- Differential SIN signal -
		6	B- Differential COS signal -
		7	0V Reference potential (0 V / GND)
		8	0V Reference potential (0 V / GND)
		9	24V Supply potential (+24 V, ≤ 200 mA)
		10	24V Supply potential (+24 V, ≤ 200 mA)
2	System bus level and digital inputs	11	24V Supply voltage (+24 V)
		12	24V Supply voltage (+24 V)
		13	24V Supply voltage (+24 V)
		14	SYS + System bus data line +
		15	0V Reference potential (0 V / GND)
		16	SYS - System bus data line -
		17	0V Reference potential (0 V / GND)
		18	0V Reference potential (0 V / GND)
		19	SI1 Safe digital input 1
		20	SI2 Safe digital input 2
		21	0V Reference potential (0 V / GND)
		22	0V Reference potential (0 V / GND)
		23	24V Supply voltage (+24 V)
		24	24V Supply voltage (+24 V)
3	Digital outputs	25	Clock 1 Clock output for safe input 1 ¹⁾ (p-switching, OSSD)
		26	Clock 2 Clock output for safe input 2 ¹⁾ (p-switching, OSSD)
		27	0V Reference potential (0 V / GND)
		28	0V Reference potential (0 V / GND)
		29	24V Supply voltage (+24 V)
		30	24V Supply voltage (+24 V)
		31	SO1 Safe output 1 (pp switching, OSSD)
		32	0V Reference potential (0 V / GND)
		33	SO2 Safe output 2 (pp switching, OSSD)
		34	SO3 Safe output 3 (pp switching, OSSD)
		35	0V Reference potential (0 V / GND)
		36	0V Reference potential (0 V / GND)
4	Diagnostics	RJ12 - 1	RS485_A Data cable RS485
		RJ12 - 2	RS485_B Data cable RS485
		RJ12 - 3	GND Reference potential (GND)
		RJ12 - 4	RS232_TxD Data cable RS232
		RJ12 - 5	RS232_RxD Data cable RS232
		RJ12 - 6	5 V Supply voltage (+5 V)

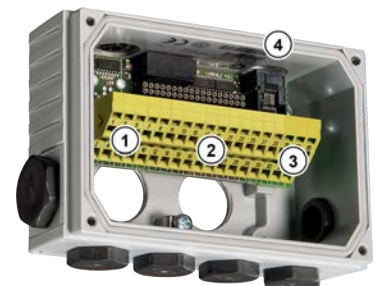

1) Clock output is not safety-rated.

NOTICE

Defect on the safe output through incorrect connection

The connection of an external voltage to the safe outputs SO1, SO2 and SO3, or to the clock outputs Clock1 and Clock2 may destroy them.

Connection of the cable sets (scope of delivery)

The following cable sets are included in scope of delivery:

- Systembus
- HTL-signal (for signal processing in the frequency inverter) ^{a)}
- Safe Stop
- Voltage supply
- PE

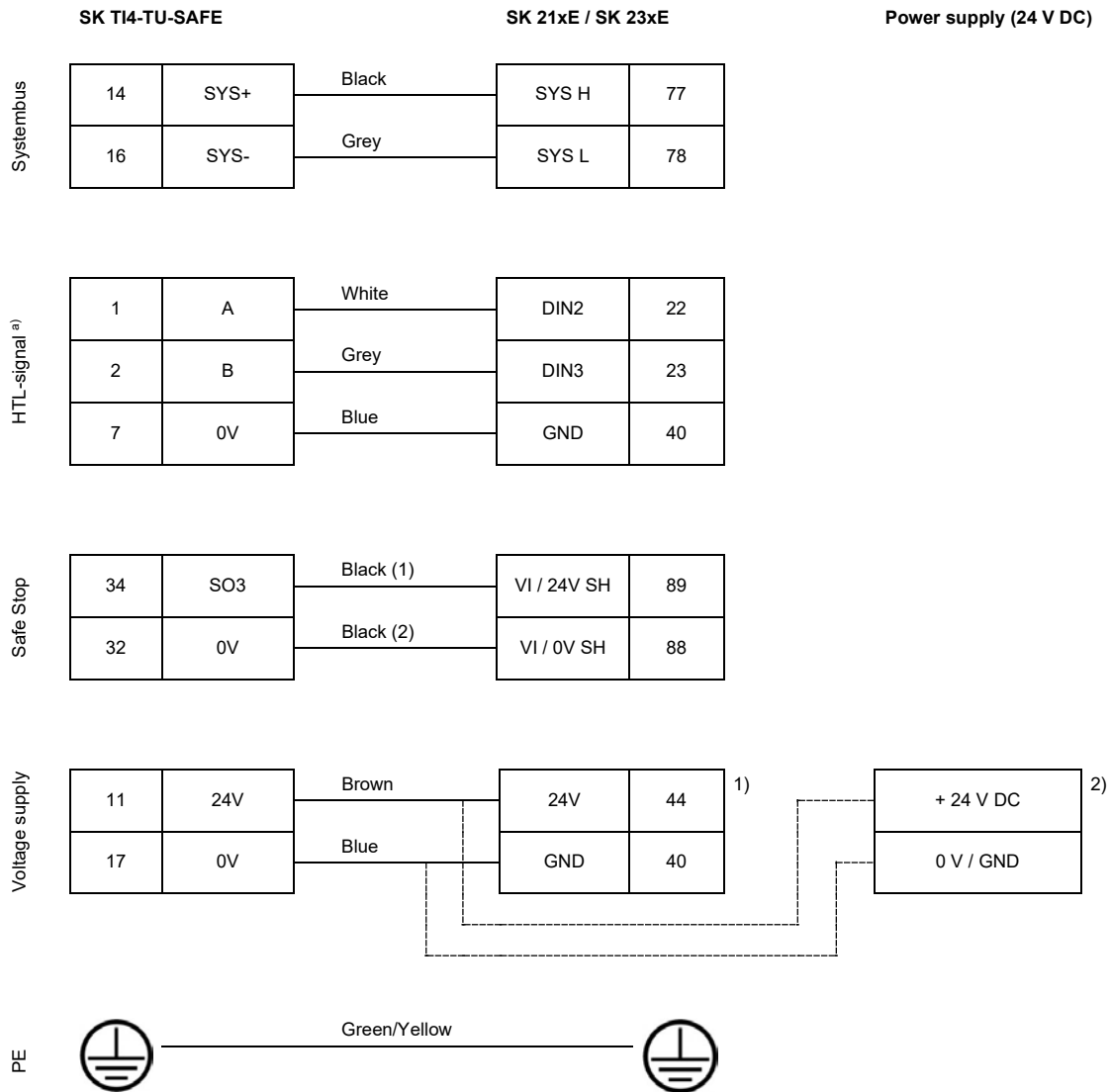

SK TI4-TU-SAFE-...

SK 21xE / SK 23xE

Power supply (24 V DC)

1) Only valid for devices SK 215E / SK 235E.

2) For devices SK 210E / SK 230E or for higher power requirements of the bus interface (eg due to IOs) an external power supply have to be used.

a) **REMARK:** Don't connect encoder!

Encoder connection

A safety SIN /COS encoder can be connected to implement the safety functions.

i Information

Measurement precision

The encoder is evaluated by measuring the frequency. The higher the working frequency which is selected, the greater the precision.

To prevent large incorrect measurements, at least 500 measuring steps per second should be selected.

The number of measuring steps per second is calculated from the speed of rotation of the encoder and the selected encoder resolution.

$$inc/s = \frac{RPM \times Resolution}{1500}$$

The following diagram shows the percentage measuring error for the set number of steps.

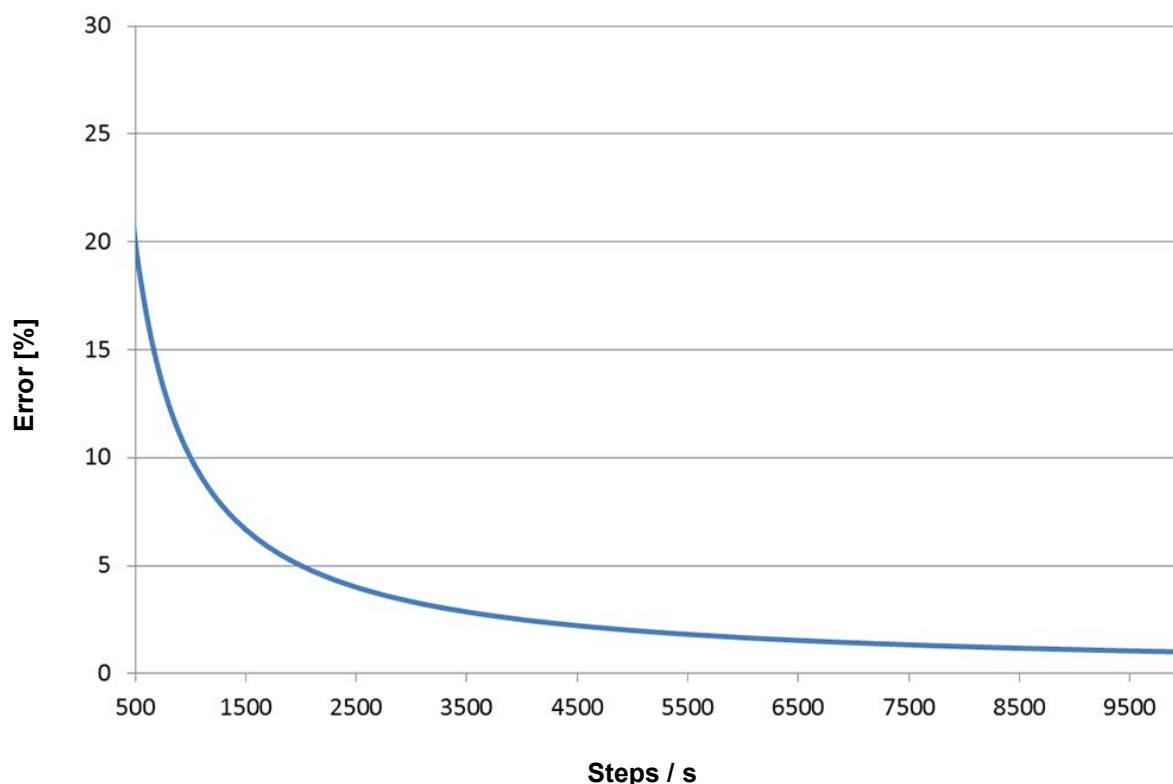

i Information

Standstill detection

With the use of a single encoder for standstill detection, reduced availability is to be expected under unfavourable EMC conditions. This must be taken into account during planning and compensated for by setting a larger maximum position error.

Configuration

Configuration of the module for remote maintenance or for the system bus is carried out via the DIP switches. The DIP - switch settings are read after a "Power On" of the module.

DIP switch											Meaning		
12	11	10	9	8	7	6	5	4	3	2	1		
X	X	X	F-address								X		
											0	System bus terminating resistor not set	
											1	System bus terminating resistor set	
Access rights for remote maintenance													
		0											Only read access to parameters possible.
		1											Read and write access to parameters possible.
		0											No control possible.
		1											Control is possible.
0												TCP/IP open connection.	
1												Secure TCP/IP connection.	

1. System bus (DIP 1)

The system bus must be terminated at both physical ends.

2. F-address (DIP 2 - 9)

Setting the F-address

3. Access rights for remote maintenance (DIP 10 – 12)

Via the Ethernet protocols TCP and UDP the module and the connected frequency inverter can be accessed using remote maintenance. The type of access is determined via the DIP - switch with inputs 10 to 12.



Factory settings DIP switches: **OFF**

LED indicators

The operating statuses of the bus interface are visualised using LED indicators.

No.	Name	Colour	Meaning
1	FE	red	F Data Error
	FS	green	F Data State
2	RUN	green	Ethernet State
	BF	red	Ethernet Error
	DS	green	Device State
	EN	red	Device error
3	Link	green	Link
	Act	yellow	Activity



PROFINET-specific LED

RUN (Ethernet State)	Meaning
OFF	No operating voltage Initialisation
Flashing green	No connection to PROFINET IO controller No parameter communication No process data communication
Green ON	Parameter communication active Process data communication active

BF (Ethernet Error)	Meaning
OFF	No error
Flashing red	No process data communication → e.g. incorrect GSDML file
Red ON	Ethernet error → there is no physical connection to a further subscriber
Double-flashing red (2 x 0.25 s, + 1 s pause)	PROFINET or FU timeout, (see also P151, P513)

Link (Green LED)	Activity (Yellow LED)	Meaning
OFF	OFF	• Bus interface not ready, no control voltage, • No bus connection (check cable connection)
ON	OFF	• Bus connection (cable connection) to another Ethernet device exists • No bus activity present
ON	Flashing (Blinking)	• Bus connection (cable connection) to another Ethernet device exists • Bus activity present

PROFIsafe-specific LED

FS (F Data State)	Meaning
OFF	No operating voltage Initialisation
Brief flashing	No cyclic SAFE data exchange
Flashing	Cyclic exchange of data, bus interface waiting for reintegration
On	Cyclic data exchange in operation



FE (F Data Error)	Meaning
OFF	No error
Red ON	SAFE- bus interface hardware error
Flashing red	PROFIsafe error (for flashing code and error codes see Manual BU 2800)

NORD-specific LEDs

DS (Device State)	EN (Device Error)	Meaning
		long flashing = 0.5 s on / 1 s off short flashing = 0.25 s on / 1 s off
OFF	OFF	Bus interface not ready, no control voltage
ON	OFF	Bus interface ready, no error, at least one frequency inverter is communicating via the system bus
ON	Short flashing	Bus interface ready, but <ul style="list-style-type: none"> • One or more of the connected frequency inverters has fault status
Long flashing	OFF	Bus interface ready and at least one other subscriber is connected to the system bus, but <ul style="list-style-type: none"> • No frequency inverter on the system bus (or connection interrupted) • One or more system bus subscriber has an address error • Software incompatible (bus interface software and FI software incompatible - update required)
Long flashing	Short flashing Flash interval 1 x - 1s pause	System bus is in status "Bus Warning" <ul style="list-style-type: none"> • Communication on system bus disrupted • No other subscribers present on system bus • Module not inserted correctly or no connection to system bus • Frequency inverter has no supply voltage
Long flashing	Short flashing Flash interval 2 x - 1s pause	System bus is in status "Bus Off" <ul style="list-style-type: none"> • The system bus 24 V power supply has been interrupted during operation
Long flashing	Short flashing Flash interval 3 x - 1s pause	System bus is in status "Bus Off" <ul style="list-style-type: none"> • The 24V voltage supply of the system bus is missing
Long flashing	Short flashing Flash interval 4 x - 1s pause	Bus interface error <ul style="list-style-type: none"> • See parameter P170
OFF	Short flashing Flash interval 1...7 - 1s pause	System error, internal program sequence interrupted <ul style="list-style-type: none"> • EMC interference (observe the wiring guidelines!) • Bus interface defective

Parameter access and diagnostics

The NORD CON software and optional control units such as the SK PAR-3H parameter box provide convenient access to the parameters of the bus interface and allow status information to be read out.

SK TU3-	SK TU4-	SK CU4- / SK TU4-
Access via RJ12 diagnostics socket of the SK 5xxE	Access via RJ12 diagnostics socket of the bus connection unit SK TI4-TU-SAFE(-C)	Access via RJ12 frequency inverter diagnostics socket, if connected to the bus interface via the system bus.
		

Further documentation and software (www.nord.com)

Software	Description
GSDML-file	Device characteristics and parameters

Software	Description
NORD CON	Parametrisation and diagnostic software

Document	Description
BU 0000	Description of NORD CON software
BU 0040	Parameter box manual
BU 0200	Frequency inverter manual SK 2xxE

Document	Description
BU 2800	PROFsafe bus communication manual
TI 275280300	Bus connection unit SK TI4-TU-SAFE