

## SK CU4-POL

Part number: 275 271 018

### POWERLINK – Internal Bus Interface

The bus interface may only be installed and commissioned by qualified electricians. An electrician is a person who, because of their technical training and experience, has sufficient knowledge with regard to

- Switching on, switching off, isolating, earthing and marking power circuits and devices,
- Proper maintenance and use of protective devices in accordance with defined safety standards.

## DANGER

### Danger of electric shock

The frequency inverter carries hazardous voltage for up to 5 minutes after being switched off.

- Work must not be carried out unless the frequency inverter has been disconnected from the voltage and at least 5 minutes has elapsed since the mains was switched off.

### Validity of document

This document is only valid in conjunction with the operating instructions of the respective frequency inverter and the bus communication manual for this bus interface ( See overview at end of document). These documents contain all of the information that is required for safe commissioning of the bus interface module and the frequency inverter.

### Scope of delivery

1 x	Bus interface	SK CU4-POL
1 x	System bus cable set	grey/black
1 x	24 VDC cable set	brown/blue
2 x	Connecting screws	M4 x 20, cross-head



### Usage area

Internal interface for connecting a decentralised frequency inverter (NORDAC *BASE*, NORDAC *FLEX*, NORDAC *LINK*) to a **POWERLINK** field bus. This is connected to the inverter via the system bus, and can directly access up to 4 frequency inverters. 2 digital inputs are available.

Technical Information / Datasheet	SK CU4-POL			
POWERLINK Bus module	TI 275271018	V 1.6	0623	en

## Technical Data

### Bus interface

Temperature range	-25 °C ... xx °C *	Vibration resistance	3M7
Temperature class	Class 3K3	Protection class	IP20
		Supply voltage	24 V ± 20 %, ≈ 100 mA Reverse polarity protected

\* The upper temperature limit depends on the frequency inverter and the operating mode → see "Derating"

Digital input - working range	Low: 0 V ... 5 V, High: 15 V ... 30 V
Digital input - specific data	R <sub>i</sub> = 10 kΩ, input capacity: 10 nF, response time 1 ms, inputs as per EN 61131-2 type 1

### Bus specification

POWERLINK	max. 100 MBaud	Cable	Min. Ethernet CAT-5
	electrical isolation 500 V <sub>eff</sub>	Max. cable length	100 m between two modules
Bus connection	Screw terminals	Shield	Direct to PE
Bus termination	performed automatically	PE connection	via PE screw cap in terminal box
Status display	6 LEDs		
Topology	Ring <sup>1</sup> , star, tree, linear bus		

<sup>1</sup> Must be supported by bus master

### Power

Update interval for process data between bus interface and frequency inverter	≥ 5 ms
Parameter read access on the frequency inverter	≈ 25 ms
Parameter write access with storage in EEPROM	≈ 70 ms
Cycle times	400 μs ... 60 ms

### Derating

Depending on the installation location of the bus interface (NORDAC *BASE* or NORDAC *FLEX*), the operating mode (S1, S3 ...) and the installation type of the frequency inverter (wall-mounting, motor-mounting) as well as the type of motor used, restrictions to the permissible ambient temperature must be taken into account. If the permissible ambient temperature is exceeded, the bus interface can heat up to an impermissible extent and switch itself off with an error message (E104.0).

Operating mode	Installation type	Maximum ambient temperature *	
		NORDAC <i>BASE</i>	NORDAC <i>FLEX</i>
S1	Motor	25 °C	30 °C
S3 ED 50 %, 10 min	Motor	40 °C	Not applicable
S3 ED 70 %, 10 min	Motor	Not applicable	40 °C
S1	Wall (unventilated)	37 °C	42 °C
S1	Wall (ventilated)	47 °C	48 °C

\* The limits of the frequency inverter must not be exceeded (please refer to the frequency inverter manual).

### Bus interface characteristics

Hot Plugging (CN connection during operation)	Yes
Isochronous (PDO)	Yes, Statistical Mapping
Number of process data	50 Byte
Asynchronous Data (SDO over ASND or UDP/IP)	Yes
Cross Traffic	No, no direct communication between CN
Addressing via	DIP switch, bus interface parameters possible
Access for NORD diagnostics tool via	Diagnostic socket on the device (if available) or possibly via frequency inverter and UDP Ethernet protocol

### Installation

Installation location	In defined option slot inside the NORDAC device.
Fastening	with screw fastenings

- 1) With NORDAC *LINK*, this assembly must be selected when ordering. The installation is then carried out at the factory. Subsequent installation is not possible.

### Installation steps

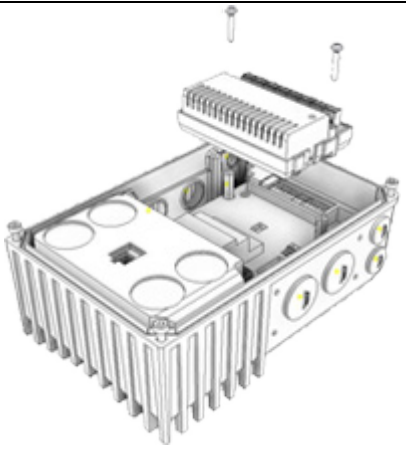
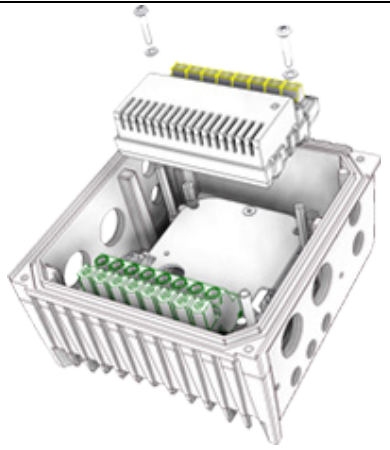
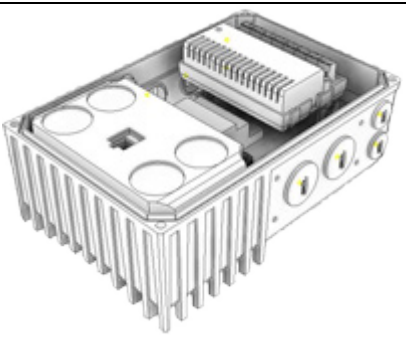
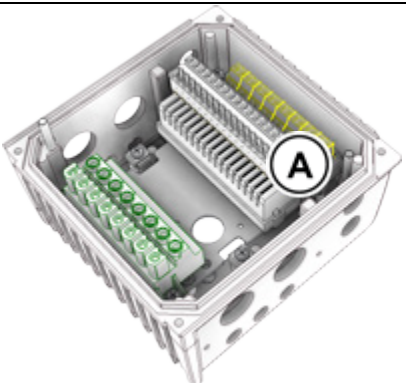
	NORDAC BASE	NORDAC FLEX *)
1.		
2.		

- \*) Before carrying out installation step 1 it may be necessary to remove the control terminal bar ( A ),  
The control terminal bar ( A ) must be fitted after installation step 2.

**Connections**

Connection is via the terminal strip of the bus interface.

Potential	Contact	Designation	Description	
1	Ethernet	E8	PHY1 RX-	Ethernet connection 2 Receive Data -
		E7	PHY1 RX+	Ethernet connection 2 Receive Data +
		E6	PHY1 TX-	Ethernet connection 2 Transmission Data -
		E5	PHY1 TX+	Ethernet connection 2 Transmission Data +
		E4	PHY0 RX-	Ethernet connection 1 Receive Data -
		E3	PHY0 RX+	Ethernet connection 1 Receive Data +
		E2	PHY0 TX-	Ethernet connection 1 Transmission Data -
		E1	PHY0 TX+	Ethernet connection 1 Transmission Data +
2	System bus level and digital inputs	78	SYS -	System bus data line -
		77	SYS +	System bus data line +
		C1	DIN1	Digital input 1
		C2	DIN2	Digital input 2
		40	GND/0V	Reference potential (0 V/GND)
		44	24 V	Supply voltage (+24 V)
		40	GND/0V	Reference potential (0 V/GND)
		44	24 V	Supply voltage (+24 V)

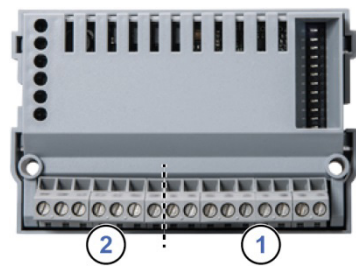

**Connection examples**

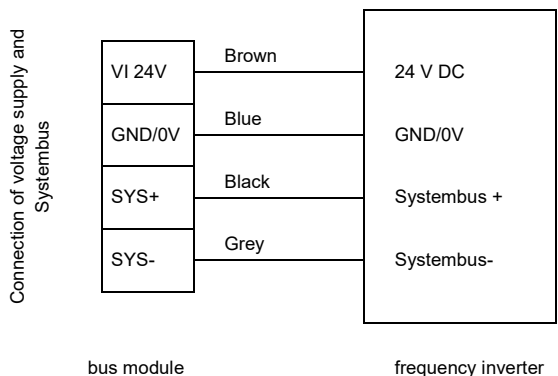

## Configuration

The basic configuration of the module is primarily carried out via its DIP switches. The DIP switch settings are read after a "Power On" of the bus interface.

DIP switch											Meaning	
12	11	10	9	8	7	6	5	4	3	2	1	Address
No function	X	X	0	0	0	0	0	0	0	0	X	0
	X	X	0	0	0	0	0	0	0	1	X	1
	X	X	0	0	0	0	0	0	1	0	X	2
	X	X	0	-	-	-	-	-	-	-	X	-
	X	X	1	1	1	0	1	1	1	1	X	239 (largest permissible address)
											0	System bus terminating resistor not set.
											1	System bus terminating resistor set.
Access rights for remote maintenance												
		0										Only read access to parameters possible.
		1										Read and write access to parameters possible.
	0											No control possible.
	1											Control is possible.

### 1. System bus (DIP 1)

The system bus must be terminated at both physical ends.

### 2. IP address (DIP 2 ... 9)

The node ID (the final byte of the IP address) can be set via this switch and controlled in parameter **P185**. The largest permissible node ID for CN is "239".

If all DIP switches 2...9 are moved to the "OFF" position, the IP address can be set via parameter **P160**.

### 3. Access rights for remote maintenance (DIP 10 ... 12)

The bus interface and the connected frequency inverter can be accessed via remote maintenance using the UDP Ethernet protocol. The type of access is defined via the DIP switch with inputs 10 to 11.

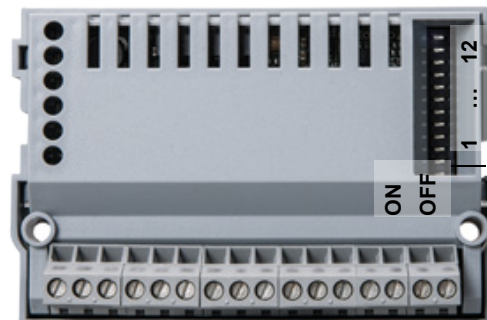

Factory settings DIP switches: **OFF**

## Information

### NORDAC LINK

With the NORDAC LINK, the DIPP switch settings can only be adjusted at the factory. Subsequent adaptation is not possible. The configuration of the module must therefore be defined when ordering.

## LED indicators

The operating statuses of the bus interface are visualised using LED indicators.

No.	Name	Colour	Meaning
1	BS	green	Module State
	BE	red	Network Error
	DS	green	Device State
	EN	red	Device error
2	L/A	green	Link/Activity

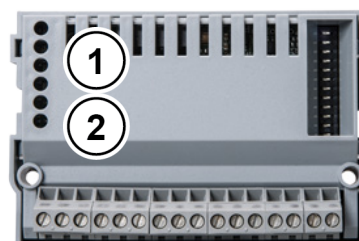

### POWERLINK-specific LEDs

BS (Module State)	Meaning
<b>OFF</b>	No communication
<b>Flashing green 1x</b>	Pre- Operational 1: Parameter communication active, no process data
<b>Flashing green 2x</b>	Pre Operational 2: as for Pre Operational 1
<b>Flashing green 3x</b>	Ready To Operate: Parameter communication active, restricted process data communication
<b>Green ON</b>	Operational: Parameter communication active, process data communication active
<b>Flashing green (10 Hz)</b>	Basic Ethernet: Parameter communication active via UDP, no process data
<b>Flashing green (2.5 Hz)</b>	Stopped: No communication

BE (Network Error)	Meaning
<b>OFF</b>	No POWERLINK error
<b>Red ON</b>	General POWERLINK error

L/A (Green LED)	Meaning
<b>OFF</b>	<ul style="list-style-type: none"> <li>• Bus interface not ready, no control voltage,</li> <li>• No bus connection (check cable connection)</li> </ul>
<b>Flashing green</b>	<ul style="list-style-type: none"> <li>• Technology unit connected and active</li> </ul>
<b>Green ON</b>	<ul style="list-style-type: none"> <li>• Technology unit ready, but</li> <li>• No bus activity present</li> </ul>

## NORD-specific LEDs

DS (Device State)	EN (Device Error)	Meaning
		long flashing = 0.5 s on / 1 s off short flashing = 0.25 s on / 1 s off
<b>OFF</b>	<b>OFF</b>	Bus interface not ready, no control voltage
<b>ON</b>	<b>OFF</b>	Bus interface ready, no error, at least one frequency inverter is communicating via the system bus
<b>ON</b>	<b>Short flashing</b>	Bus interface ready, but <ul style="list-style-type: none"> <li>• One or more of the connected frequency inverters has fault status</li> </ul>
<b>Long flashing</b>	<b>OFF</b>	Bus interface ready and at least one other subscriber is connected to the system bus, but <ul style="list-style-type: none"> <li>• No frequency inverter on the system bus (or connection interrupted)</li> <li>• One or more system bus subscriber has an address error</li> <li>• Software incompatible (bus interface software and FI software incompatible - update required)</li> </ul>
<b>Long flashing</b>	<b>Short flashing</b> Flash interval 1 x - 1s pause	System bus is in status "Bus Warning" <ul style="list-style-type: none"> <li>• Communication on system bus disrupted</li> <li>• No other subscribers present on system bus</li> <li>• Module not inserted correctly or no connection to system bus</li> <li>• Frequency inverter has no supply voltage</li> </ul>
<b>Long flashing</b>	<b>Short flashing</b> Flash interval 2 x - 1s pause	System bus is in status "Bus Off" <ul style="list-style-type: none"> <li>• The system bus 24 V power supply has been interrupted during operation</li> </ul>
<b>Long flashing</b>	<b>Short flashing</b> Flash interval 3 x - 1s pause	System bus is in status "Bus Off" <ul style="list-style-type: none"> <li>• The 24V voltage supply of the system bus is missing</li> </ul>
<b>Long flashing</b>	<b>Short flashing</b> Flash interval 4 x - 1s pause	Bus interface error <ul style="list-style-type: none"> <li>• See parameter P170</li> </ul>
<b>OFF</b>	<b>Short flashing</b> Flash interval 1...7 - 1s pause	System error, internal program sequence interrupted <ul style="list-style-type: none"> <li>• EMC interference (observe the wiring guidelines!)</li> <li>• Bus interface defective</li> </ul>

### Parameter access and diagnosis

The NORDCON software or optional control units such as the SK PAR-3H ParameterBox provide convenient access to the parameters of the bus interface and allow status information to be read out. In addition, the NORDCON *APP* – in connection with the NORDAC *ACCESS BT* Bluetooth stick – offers a practical way of mobile and wireless maintenance as well as commissioning of NORD frequency inverters.

Access is via the RJ12 diagnostics socket of the frequency inverter. The prerequisite for this is that the bus interface is connected to the frequency inverter via the system bus.

### Further documentation and software ([www.nord.com](http://www.nord.com))

Software	Description
<a href="#">XDD-file</a>	Device characteristics and parameters

Software	Description
<a href="#">NORDCON</a>	Parametrisation and diagnostic software

Document	Description
<a href="#">BU 0000</a>	Description of NORDCON software
<a href="#">BU 0040</a>	Parameter box manual
<a href="#">BU 0180</a>	Frequency inverter manual NORDAC <i>BASE</i>
<a href="#">BU 0200</a>	Frequency inverter manual NORDAC <i>FLEX</i>
<a href="#">BU 0250</a>	Frequency inverter manual NORDAC <i>LINK</i>

Document	Description
<a href="#">TI 275274514</a>	SK TIE4-M12-ETH Ethernet connection expansion entrance/exit
<a href="#">TI 275274505</a>	SK TIE4-M12-SYSS System bus connection expansion exit
<a href="#">TI 275274506</a>	SK TIE4-M12-SYSS System bus connection expansion entrance
<a href="#">BU 2200</a>	POWERLINK bus communication manual