

## SK CU4-PBR

Part number: 275 271 000

### PROFIBUS® DP – Internal Bus Interface

The bus interface may only be installed and commissioned by qualified electricians. An electrician is a person who, because of their technical training and experience, has sufficient knowledge with regard to

- Switching on, switching off, isolating, earthing and marking power circuits and devices,
- Proper maintenance and use of protective devices in accordance with defined safety standards.

### DANGER

### Danger of electric shock

The frequency inverter carries hazardous voltage for up to 5 minutes after being switched off.

- Work must not be carried out unless the frequency inverter has been disconnected from the voltage and at least 5 minutes has elapsed since the mains was switched off!

### NOTICE

### Validity of document

This document is only valid in conjunction with the operating instructions of the respective frequency inverter and the bus communication manual for this bus interface (📖 See overview at end of document). These documents contain all of the information that is required for safe commissioning of the bus interface module and the frequency inverter.

### Scope of delivery

1 x	Bus interface	SK CU4-PBR
1 x	System bus cable set	grey/black
1 x	24 VDC cable set	brown/blue
2 x	Connecting screws	M4 x 20, cross-head



### Usage area

Internal interface for the connection of a decentralised frequency inverter (SK 2xxE) to a **PROFIBUS DP** field bus. This is connected to the inverter via the system bus, and can directly access up to 4 frequency inverters. 2 digital inputs are available.

Technical Information / Datasheet	SK CU4-PBR			
PROFIBUS DP Bus module	TI 275271000	V 1.0	4116	EN

## Technical Data

### Bus interface

Temperature range	-25 °C...50 °C	Vibration resistance	3M7
Temperature class	Class 3K3	Firmware version	V1.4 R0
Protection class	IP20	Supply voltage	24 V ± 20 %, ≈ 90 mA Reverse polarity protected

Digital input - working range	Low: 0 V ... 5 V, High: 15 V ... 30 V
Digital input - specific data	R <sub>i</sub> = 8.1 kΩ, input capacity: 10 nF, response time 1 ms, inputs as per EN 61131-2 type 1

### Bus specification

PROFIBUS DP	Max. 12 MBit/s electrical isolation 500 V <sub>eff</sub>								
Bus connection	Screw terminals								
Bus termination	via DIP switch on the bus interface								
Status display	6 LEDs								
Topology	Linear bus								
Power setting	PROFIBUS DP-V1								
Cable	Cable type A according to EN 50170 (drilled, shielded two conductor cable)								
Cable length	depending on transmission speed: <table border="1" data-bbox="454 1131 917 1254"> <thead> <tr> <th>Bus cable length</th> <th>Transfer rate</th> </tr> </thead> <tbody> <tr> <td>400 m</td> <td>500 KBit/s</td> </tr> <tr> <td>200 m</td> <td>1500 KBit/s</td> </tr> <tr> <td>100 m</td> <td>3...12 MBit/s</td> </tr> </tbody> </table>	Bus cable length	Transfer rate	400 m	500 KBit/s	200 m	1500 KBit/s	100 m	3...12 MBit/s
Bus cable length	Transfer rate								
400 m	500 KBit/s								
200 m	1500 KBit/s								
100 m	3...12 MBit/s								
Shield	Direct to PE								
PE connection	via PE screw cap in terminal box								

### Power

Update interval for process data between bus interface and frequency inverter	≈ 5 ms
Parameter read access on the frequency inverter	≈ 12 ms
Parameter write access with storage in EEPROM	≈ 25 ms

**Bus interface characteristics**

Communication Performance levels DP-V0	Cyclic useful data connection between DP master and DP slaves (point-to-point useful data communication or Multicast)						
Communication Performance levels DP-V1	Acyclic data communication between DP master DPM1 and DP slaves						
Transfer Method	RS485						
Addressing	<table border="1"> <thead> <tr> <th>SK TU3-PBR</th> <th>SK TU3-PBR-24V</th> <th>SK xU4-PBR</th> </tr> </thead> <tbody> <tr> <td>Parameter <b>P508</b> at frequency inverter</td> <td>Rotary coding switch or parameter <b>P508</b> at frequency inverter</td> <td>DIP switch or parameter <b>P160</b></td> </tr> </tbody> </table>	SK TU3-PBR	SK TU3-PBR-24V	SK xU4-PBR	Parameter <b>P508</b> at frequency inverter	Rotary coding switch or parameter <b>P508</b> at frequency inverter	DIP switch or parameter <b>P160</b>
SK TU3-PBR	SK TU3-PBR-24V	SK xU4-PBR					
Parameter <b>P508</b> at frequency inverter	Rotary coding switch or parameter <b>P508</b> at frequency inverter	DIP switch or parameter <b>P160</b>					
Synchronisation	Sync mode (synchronisation of outputs) and Freeze mode (synchronisation of inputs)						
Bus access	<ul style="list-style-type: none"> <li>• Token Passing procedure</li> <li>• Master/Slave procedure</li> <li>• Mono-Master or Multi-Master System</li> </ul>						
Access for NORD diagnosis tool via	diagnostics socket on the device (if available) and via frequency inverter						

**Installation**

Installation location	Within the connection unit of a frequency inverter (SK 180E, SK 190E, 2xxE)
Fastening	with screw fastenings

**Installation steps**

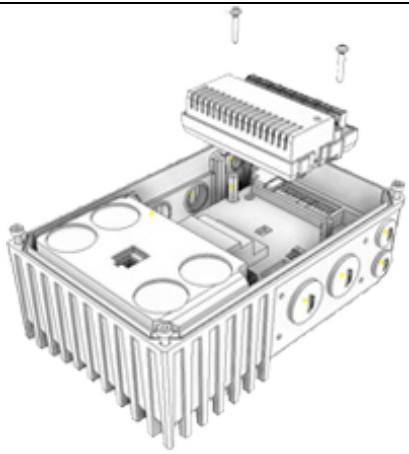
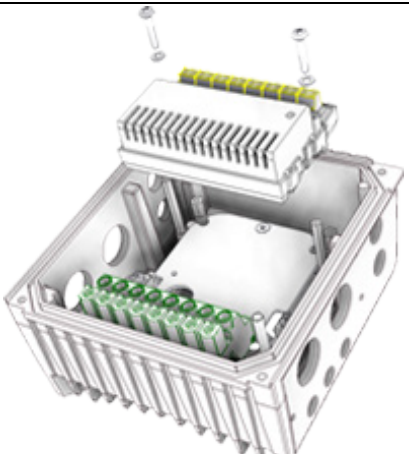
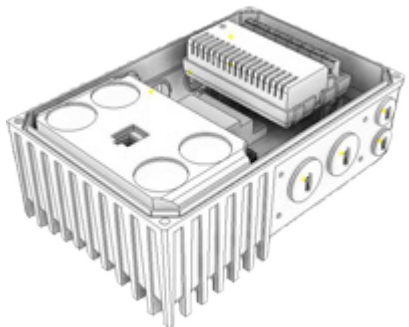
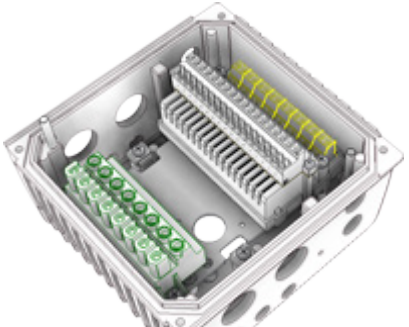
	SK 1xxE	SK 2xxE
1.		
2.		

### Connections

Connection is via the terminal strip of the bus interface.

Potential	Contact	Designation	Description	
1	System bus level and digital inputs	44	24 V	Supply potential (+24 V ±20%, 90 mA)
		40	GND/0 V	Reference potential (0 V/GND)
		C1	DIN1	Digital input 1 (I/O PROFIBUS DP DIN1)
		C2	DIN2	Digital input 2 (I/O PROFIBUS DP DIN2)
		77	Sys H	System bus data line +
		78	Sys L	System bus data line -
		40	GND/0 V	Reference potential (0 V/GND)
		44	24 V	Supply potential (+24 V ±20%, 90 mA)
2	PROFIBUS DP	82	PBR B	Receive / transmit line, positive
		81	PBR A	Receive / transmit line, negative
		46	GND/0 V Bus	Reference potential for data transmission
		83	RTS	Ready to send
		47	VO/5 V Bus	+5 V bus supply voltage
		82	PRB B	Receive / transmit line, positive
		81	PRB A	Receive / transmit line, negative
		46	GND/0 V Bus	Bus reference potential

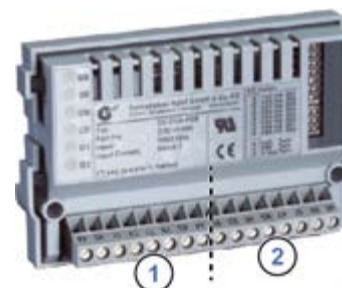

### Schematic diagram - electrical connection

(Terminal designation for the example of NORD frequency inverters SK 180E ... SK 2xxE)

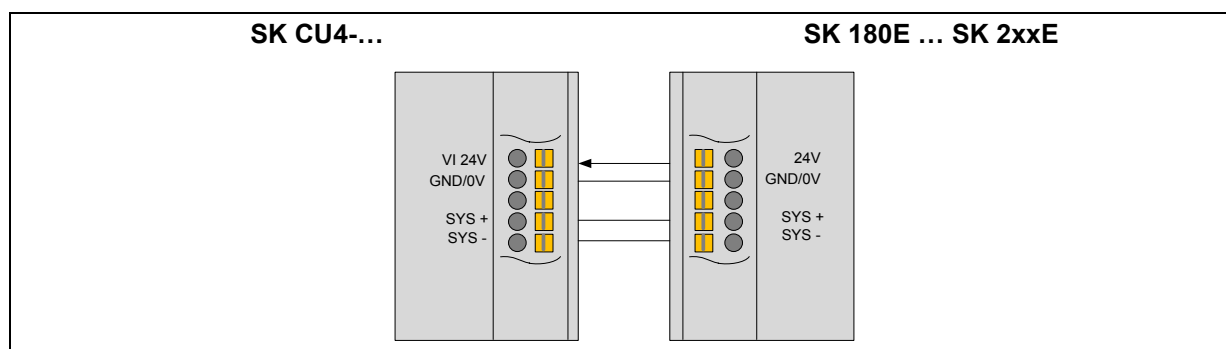

### Configuration

The PROFIBUS address of the bus interface (1) is set via the DIP switches. If the bus interface is the final subscriber on the PROFIBUS field bus or the NORD system bus, the terminating resistors (2) and (3) must be activated.

The DIP switch settings are read in after a “Power On” of the bus interface.

DIP switch	Meaning	Department	Meaning
8	—	Addressing	Bus interface PROFIBUS address
7	Address bit 6		
6	Address bit 5		
5	Address bit 4		
4	Address bit 3		
3	Address bit 2		
2	Address bit 1		
1	Address bit 0	Bus terminal	Terminating resistor for PROFIBUS field bus
E	PB Term.		Termination resistor for NORD system bus
2	PB Term.		
1	S-Bus Term.		

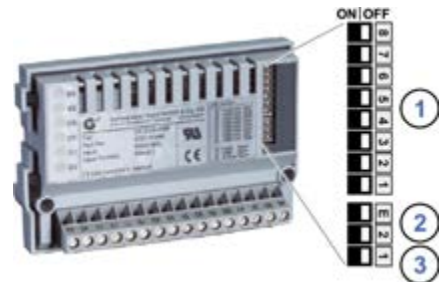

#### 1. Addressing (DIP 7 ... 1)

The PROFIBUS is set with binary coding using DIP switches 7...1.  
Address area "3"..."125".

#### 2. Terminating resistors for PROFIBUS field bus (DIP E and 2).

Both DIP switches E and 2 must be moved to the “ON” position if the bus interface is the final subscriber on the bus.

#### 3. Termination resistor for NORD system bus (DIP 1)

Set DIP switch 1 to the “ON” position if the bus interface is the final subscriber on the bus.

### LED indicators

The operating statuses of the bus interface are visualised using LED indicators.

No.	Name	Colour	Meaning
1	BR	red/green	PROFIBUS DP Status
	BE	red/green	PROFIBUS DP Error
2	DS	green	Device State
	EN	red	Device error
3	D1	green	Digital input D1
	D2	green	Digital input D2



*PROFIBUS DP-specific LED*

BR (Bus Ready, PROFIBUS DP Status)	BE (Bus Error, PROFIBUS DP Error)	Meaning
OFF	OFF	Bus interface not ready, no voltage supply or signalling of a system fault via the "DS" and "DE" LEDs.
Steady illumination in green	OFF	Normal operation, cyclic data exchange via PROFIBUS DP.
Flashing green (0.5 s)	OFF	Technology unit has not been configured by the DP master, no cyclic data exchange: <ul style="list-style-type: none"> <li>• PROFIBUS DP cable not connected</li> <li>• Addressing error</li> <li>• PROFIBUS DP-Master in "STOP" state</li> <li>• Defective hardware configuration (e.g. More than 4 connected frequency inverters)</li> </ul>
Steady illumination in red	Steady illumination in red	Communication timeout: Address monitoring time in PROFIBUS DP master expired.
Steady illumination in red	Flashing red (0.5 s)	Timeout during process data reception: The time set in parameter <b>P151 External bus timeout</b> has elapsed without new process data being received.
Flashing red (0.5 s)	Flashing red (0.5 s)	No communication between bus interface and PROFIBUS DP master: <ul style="list-style-type: none"> <li>• Incorrect address range (permitted range "3"..."125")</li> <li>• Bus interface defective</li> </ul>

*NORD-specific LEDs*

DS (Device State)	EN (Device Error)	Meaning long flashing = 0.5 s on / 1 s off short flashing = 0.25 s on / 1 s off
OFF	OFF	Bus interface not ready, no control voltage
ON	OFF	Bus interface ready, no error, at least one frequency inverter is communicating via the system bus
ON	Short flashing	Bus interface ready, but <ul style="list-style-type: none"> <li>• One or more of the connected frequency inverters has fault status</li> </ul>
Long flashing	OFF	Bus interface ready and at least one other subscriber is connected to the system bus, but <ul style="list-style-type: none"> <li>• No frequency inverter on the system bus (or connection interrupted)</li> <li>• One or more system bus subscriber has an address error</li> <li>• Software incompatible (bus interface software and FI software incompatible - update required)</li> </ul>
Long flashing	Short flashing Flash interval 1 x - 1 s pause	System bus is in status "Bus Warning" <ul style="list-style-type: none"> <li>• Communication on system bus disrupted</li> <li>• No other subscribers present on system bus</li> <li>• Module not inserted correctly or no connection to system bus</li> <li>• Frequency inverter has no supply voltage</li> </ul>
Long flashing	Short flashing Flash interval 2 x - 1 s pause	System bus is in status "Bus Off" <ul style="list-style-type: none"> <li>• The system bus 24 V power supply has been interrupted during operation</li> </ul>
Long flashing	Short flashing Flash interval 3 x - 1 s pause	System bus is in status "Bus Off" <ul style="list-style-type: none"> <li>• The 24 V voltage supply of the system bus is missing</li> </ul>
Long flashing	Short flashing Flash interval 4 x - 1 s pause	Bus interface error <ul style="list-style-type: none"> <li>• See parameter <b>P170</b></li> </ul>
OFF	Short flashing Flash interval 1 x - 1 s pause	System error, internal program sequence interrupted <ul style="list-style-type: none"> <li>• EMC interference (observe the wiring guidelines!)</li> <li>• Bus interface defective</li> </ul>

*Digital input LEDs*

LED (green)	Display	Meaning
D1	ON	"High" potential present at terminal "C1".
	OFF	"Low" potential present at terminal "C1".
D2	ON	"High" potential present at terminal "C2".
	OFF	"Low" potential present at terminal "C2".

## Error messages

Error messages from the bus interface – current or archived messages relating to the last fault - can be read out via module parameter **P170** (SK xU4-PBR only). The error messages are lost if the bus interface is switched off.

Error	Meaning	Remarks
100.0	EEPROM error	EMC faults, bus interface defective
101.0	System bus 24 V missing	No 24 V voltage on bus, connections not correct
102.0	Bus timeout P151	By means of timeout supervision parameter <b>P151/P513</b>
103.0	System bus BUS OFF	No 24 V supply to the bus, connections not correct
500.0	PROFIBUS ASIC error	No communication with ASIC
501.0	PROFIBUS address incorrect	Address outside permissible range (3...125)
502.0	PROFIBUS Timeout	Telegram transfer error

Bus interface-related errors are depicted as follows in the error memory of the frequency inverter (**P700 / P701**).

Error (E010)	Meaning	Remarks
10.0	Connection error	Contact to bus interface lost
10.2	PROFIBUS telegram failure	Telegram transfer error <ul style="list-style-type: none"> <li>• Check the connections and links, program sequence and Bus Master.</li> </ul>
10.3	Timeout by <b>P151/P513</b>	Telegram transfer error. <ul style="list-style-type: none"> <li>• Check watchdog time (P151).</li> <li>• Check the connections and links and the program sequence in the Bus Master.</li> </ul> The release bit is missing in the control word.
10.4	External bus interface initialisation error	Unable to address bus interface. <ul style="list-style-type: none"> <li>• Check parameter <b>P746</b> setting.</li> <li>• Check power supply of bus interface.</li> <li>• Check the connections and links.</li> </ul>
10.8	External bus interface communication error	Only SK TU3-PBR bus interface: Connection between bus interface and frequency inverter interrupted.
10.9	Missing bus interface	Only bus interfaces SK CU4-PBR and SK TU4-PBR: Connection between bus interface and frequency inverter interrupted (see setting of parameter <b>P120</b> ).

## Parameter

*Frequency inverter:* The following frequency inverter parameters must be adapted for setting up communication between the frequency inverter and the bus interface (for details please refer to the frequency inverter manual).

Parameter [-Array]	Meaning	Remarks
<b>P120</b> [-01]	Option monitoring	"Auto" (default setting) Only SK xU4
<b>P509</b>	Source Control Word	SK TU3-... on SK 5xxE: " <b>Profibus</b> " SK xU4-... on SK 180/SK 2xxE: " <b>System bus</b> "
<b>P510</b> [-01]...[-02]	Setpoint source	"Auto" (default setting)
<b>P513</b>	Time-out	Monitoring of the SK TU3 bus interface Only SK 5xxE
<b>P543</b> [-01]...[-03] and <b>P543</b> ... <b>P545</b>	Bus actual value (1...3)	Possible settings according to <b>P418</b>
<b>P546</b> [-01]...[-03] ([-05]) and <b>P546</b> ... <b>P548</b>	Bus setpoint value (1...3)	Possible settings according to <b>P400</b>
<b>P700</b> [-01]/ <b>P701</b>	Current/last faults	Information parameter
<b>P740/P741</b>	Process data bus In / Out	Information parameter
<b>P745</b>	Module version	Information parameter Only SK TU3
<b>P746</b>	Module status	Information parameter Only SK TU3
<b>P748</b>	CANopen/System bus status	Information parameter



*Bus interface:* The bus interface provides a selection of appropriate parameters for setting or displaying special operating values. Parameters can be adapted using the NORDCON software or an

SK PAR-3H / -3E parameter box. All parameters can still be read and written by the bus master via PROFIBUS DP.

Parameter [-Array]	Meaning	Remarks
P150	Set relays	Set DOUT directly or control via BUS
P151	External bus time-out	Monitoring of SK xU4 bus interface
P152	Factory setting	Reset bus interface parameters
P153 [-01]...[-02]	Minimum system bus cycle	Reduction of bus load on the system bus caused by the bus interface
P154 [-01]...[-02]	Access to option card I/O	Administration of read and write rights to the IO of the module
P160	Profibus address	Set bus interface PROFIBUS-DP address
P170 [-01]...[-02]	Present errors	Display bus interface errors
P171 [-01]...[-03]	Software version	Firmware version/Revision
P172	Configuration	Bus interface type
P173	Module status	Status of system bus or the connected FI
P174	Status of digital inputs	Image of the switching status of DIN
P175	Digital output state	Image of the switching status of DOUT
P176 [-01]...[-17]	Process data bus In	Information parameter
P177 [-01]...[-17]	Process data bus Out	Information parameter
P180	Profibus address	Information parameter
P181	Profibus baud rate	Information parameter
P182	PPO Type	Information parameter

### Parameter access and diagnostics

The NORD CON software and optional control units such as the SK PAR-3H parameter box provide convenient access to the parameters of the bus interface and allow status information to be read out.

SK TU3-	SK TU4-	SK CU4- / SK TU4-
Access via RJ12 diagnostics socket of the SK 5xxE	Access via RJ12 diagnostics socket of the bus connection unit <b>SK TI4-TU-BUS(-C)</b>	Access via RJ12 frequency inverter diagnostics socket, if connected to the bus interface via the system bus.
		

### Further documentation and software ([www.nord.com](http://www.nord.com))

Software	Description
<a href="#">GSD-file</a>	Device characteristics and parameters

Software	Description
<a href="#">NORD CON</a>	Parametrisation and diagnostic software

Document	Description
<a href="#">BU 0000</a>	Description of NORD CON software
<a href="#">BU 0040</a>	Parameter box manual
<a href="#">BU 0180</a>	Frequency inverter manual SK 180E, SK 190E
<a href="#">BU 0200</a>	Frequency inverter manual SK 2xxE

Document	Description
<a href="#">BU 2700</a>	PROFINET DP bus communication manual
<a href="#">TI 275274505</a>	SK TIE4-M12-SYSS System bus connection expansion exit
<a href="#">TI 275274506</a>	SK TIE4-M12-SYSS System bus connection expansion entrance
<a href="#">TI 275274500</a>	SK TIE4-M12-PRB Ethernet connection expansion PROFIBUS DP input/output