

SK CU4-DEV

Part number: 275 271 002

DeviceNet® – Internal Bus Interface

The bus interface may only be installed and commissioned by qualified electricians. An electrician is a person who, because of their technical training and experience, has sufficient knowledge with regard to

- Switching on, switching off, isolating, earthing and marking power circuits and devices,
- Proper maintenance and use of protective devices in accordance with defined safety standards.

DANGER

Danger of electric shock

The frequency inverter carries hazardous voltage for up to 5 minutes after being switched off.

- Work must not be carried out unless the frequency inverter has been disconnected from the voltage and at least 5 minutes has elapsed since the mains was switched off!

NOTICE

Validity of document

This document is only valid in conjunction with the operating instructions of the respective frequency inverter and the bus communication manual for this bus interface (📖 See overview at end of document). These documents contain all of the information that is required for safe commissioning of the bus interface module and the frequency inverter.

Scope of delivery

1 x	Bus interface	SK CU4-DEV
1 x	System bus cable set	grey/black
1 x	24 VDC cable set	brown/blue
2 x	Connecting screws	M4 x 20, cross-head



Usage area

Internal interface for connecting a decentralised frequency inverter (SK 2xxE) to a **DeviceNet** field bus. This is connected to the inverter via the system bus, and can directly access up to 4 frequency inverters. 2 digital inputs are available.

Technical Information / Datasheet		SK CU4-DEV			
DeviceNet Bus module		TI 275271002	V 1.1	3517	en

Technical Data

Bus interface

Temperature range	-25 °C...50 °C	Vibration resistance	3M7
Temperature class	Class 3K3	Firmware version	V1.5 R0
Protection class	IP20	Supply voltage	24 V ± 20 %, ≈ 100 mA Reverse polarity protected

Digital input - working range	Low: 0 V ... 5 V, High: 15 V ... 30 V
Digital input - specific data	R _i = 8.1 kΩ, input capacity: 10 nF, response time 1 ms, inputs as per EN 61131-2 type 1

Bus specification

DeviceNet	Max. 500 kBit/s								
	electrical isolation 500 V _{eff}								
Bus connection	Screw terminals								
Bus termination	via DIP switch on the bus interface								
Status display	6 LEDs								
Topology	Linear bus								
Cable	twisted, shielded two-conductor cable								
Cable length	depending on transmission speed:								
	<table border="1" data-bbox="454 1093 917 1220"> <thead> <tr> <th>Bus cable length</th> <th>Transfer rate</th> </tr> </thead> <tbody> <tr> <td>Up to 100 m</td> <td>500 KBit/s</td> </tr> <tr> <td>100...250 m</td> <td>250 KBit/s</td> </tr> <tr> <td>250...500 m</td> <td>125 KBit/s</td> </tr> </tbody> </table>	Bus cable length	Transfer rate	Up to 100 m	500 KBit/s	100...250 m	250 KBit/s	250...500 m	125 KBit/s
	Bus cable length	Transfer rate							
	Up to 100 m	500 KBit/s							
	100...250 m	250 KBit/s							
250...500 m	125 KBit/s								
Shield	Direct to PE								
PE connection	via PE screw cap in terminal box								

Power

Update interval for process data between bus interface and frequency inverter	< 5 ms
Parameter read access on the frequency inverter	< 12 ms
Parameter write access with storage in EEPROM	≈ 25 ms

Bus interface characteristics

Parametrisation	DeviceNet via Explicit Messages				
Addressing	<table border="1" data-bbox="782 1675 1241 1742"> <tr> <td>SK TU3-DEV</td> <td>SK xU4-DEV</td> </tr> <tr> <td>via Rotary coding switch</td> <td>via DIP switch</td> </tr> </table>	SK TU3-DEV	SK xU4-DEV	via Rotary coding switch	via DIP switch
	SK TU3-DEV	SK xU4-DEV			
via Rotary coding switch	via DIP switch				
Setting the baud rate	<table border="1" data-bbox="782 1742 1241 1809"> <tr> <td>SK TU3-DEV</td> <td>SK xU4-DEV</td> </tr> <tr> <td>via Rotary coding switch</td> <td>via DIP switch</td> </tr> </table>	SK TU3-DEV	SK xU4-DEV	via Rotary coding switch	via DIP switch
	SK TU3-DEV	SK xU4-DEV			
via Rotary coding switch	via DIP switch				
Supported DeviceNet connection types	• Explicit Messaging Connection				
	• Polled I/O Connection				
	• Bit Strobe I/O Connection				
	• Change of State/Cyclic I/O Connection				
Access for NORD diagnosis tool via	diagnostics socket on the device (if available) and via frequency inverter				

Installation

Installation location	Within the connection unit of a frequency inverter (SK 180E, SK 190E, 2xxE)
Fastening	with screw fastenings

Installation steps

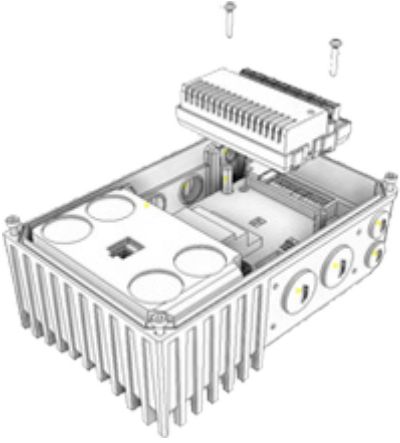
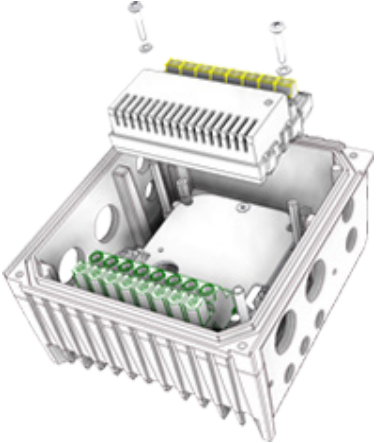
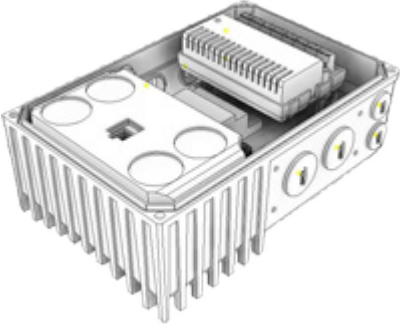
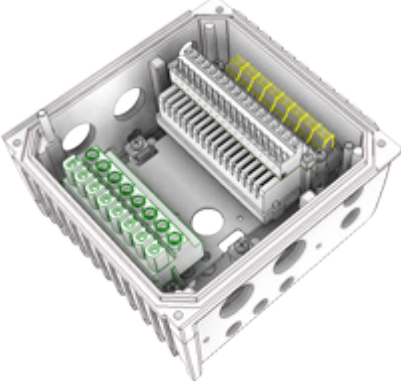
	SK 1xxE	SK 2xxE
1.		
2.		

Connections

Connection is via the terminal strip of the bus interface.

Potential	Contact	Designation	Description	
1	System bus level and digital inputs	44	24 V	Supply potential (+24 V ±20%, 50 mA)
		40	GND	Reference potential (0 V/GND)
		C1	DIN1	Digital input 1 (I/O DeviceNet DIN1)
		C2	DIN2	Digital input 2 (I/O DeviceNet DIN2)
		77	Sys +	System bus data line +
		78	Sys -	System bus data line -
		40	GND	Reference potential (0 V/GND)
2	DeviceNet	45	24 V Bus	24 V supply voltage field bus
		75	DeviceNet+	Bus connection 1 Receive Data +
		76	DeviceNet-	Bus connection 1 Receive Data -
		46	GND Bus	Bus reference potential
		90	SHLD	Bus line shield
		45	24 V Bus	Supply potential (+24 V ±20%, 50 mA)
		75	DeviceNet+	Bus connection 2 Transmit Data +
		76	DeviceNet-	Bus connection 2 Transmit Data -
46	GND Bus	Bus reference potential		



Connection examples

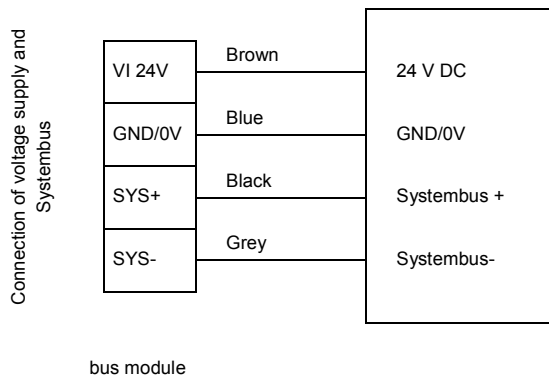

Configuration

The bus address (MAC ID), the bus interface (1) and the baud rate (2) are set via the DIP switches. The DIP switch settings are read in after a “Power On” of the bus interface.

If the bus interface is the final subscriber on the DeviceNet field bus or the NORD system bus, the terminating resistor (3) must be activated.

DIP switch	Meaning	Department	Meaning
8	MAC ID Bit 5	Addressing	Bus address (MAC ID) of bus interface
7	MAC ID Bit 4		
6	MAC ID Bit 3		
5	MAC ID Bit 2		
4	MAC ID Bit 1		
3	MAC ID Bit 0	Baud rate	Bus interface baud rate
2	Baud rate bit 1		
1	Baud rate bit 0	Bus terminal	Not used
E	—		Not used
2	—		Terminating resistor for DeviceNet field bus and NORD system bus
1	S-Bus Term.		

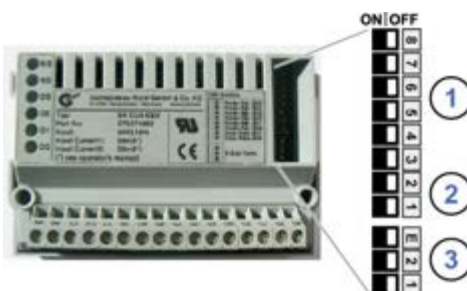

1. Addressing (DIP 8 ... 3)

The setting of the bus address takes place with binary coding using DIP switches 8...3.

Address area "0"..."63".

2. Baud rate (DIP 2 ... 1)

The setting of the node ID takes place with binary coding using DIP switches 2...1.

DIP switch 2	DIP switch 1	Baud rate
OFF	OFF	125 kBaud
OFF	ON	250 kBaud
ON	OFF	500 kBaud

3. Termination resistor (DIP E... 1)

Set DIP switch 1 to the “ON” position if the bus interface is the final subscriber on the bus.

LED indicators

The operating statuses of the bus interface are visualised using LED indicators.

No.	Name	Colour	Meaning
1	MS	red/green	Device Module status
	NS	red/green	DeviceNet Network status
2	DS	green	Device State
	EN	red	Device error
3	D1	green	Digital input D1
	D2	green	Digital input D2



DeviceNet-specific LED

MS (DeviceNet Module status)	Meaning
OFF	No voltage supply
Steady illumination in green	Bus interface ready
Flashing green (0.5 s)	<ul style="list-style-type: none"> Bus interface in standby mode. No connection to one or more frequency inverters. No parameters exchanged, setpoint specifications via the AC profile not possible. Baud rate setting for DeviceNet field bus is invalid.
Steady illumination in red	A fault that cannot be acknowledged has occurred. The bus interface may be defective and must be replaced.
Flashing red (0.5 s)	A fault that can be acknowledged has occurred on the bus interface.

NS (DeviceNet Network status)	Meaning
OFF	<ul style="list-style-type: none"> No voltage supply. The bus interface has not performed the "DUP_MAC_ID" test.
Steady illumination in green	Normal operation, cyclic data exchange via DeviceNet field bus.
Flashing green (0.5 s)	Bus interface is "Online" and has performed the "Dup_Mac_ID" test but has not established a connection to field bus subscribers.
Steady illumination in red	A serious communication error has occurred (e.g. bus off, duplicated bus address or invalid baud rate setting).
Flashing red (0.5 s)	The I/O connection or the function of parameter P151 has triggered a timeout error. The flash code is displayed for at least 5 seconds.

NORD-specific LEDs

DS (Device State)	EN (Device Error)	Meaning
		long flashing = 0.5 s on / 1 s off short flashing = 0.25 s on / 1 s off
OFF	OFF	Bus interface not ready, no control voltage
ON	OFF	Bus interface ready, no error, at least one frequency inverter is communicating via the system bus
ON	Short flashing	Bus interface ready, but <ul style="list-style-type: none"> One or more of the connected frequency inverters has fault status
Long flashing	OFF	Bus interface ready and at least one other subscriber is connected to the system bus, but <ul style="list-style-type: none"> No frequency inverter on the system bus (or connection interrupted) One or more system bus subscriber has an address error Software incompatible (bus interface software and FI software incompatible - update required)
Long flashing	Short flashing Flash interval 1 x - 1 s pause	System bus is in status "Bus Warning" <ul style="list-style-type: none"> Communication on system bus disrupted No other subscribers present on system bus Module not inserted correctly or no connection to system bus Frequency inverter has no supply voltage
Long flashing	Short flashing Flash interval 2 x - 1 s pause	System bus is in status "Bus Off" <ul style="list-style-type: none"> The system bus 24 V power supply has been interrupted during operation
Long flashing	Short flashing Flash interval 3 x - 1 s pause	System bus is in status "Bus Off" <ul style="list-style-type: none"> The 24 V voltage supply of the system bus is missing
Long flashing	Short flashing Flash interval 4 x - 1 s pause	Bus interface error <ul style="list-style-type: none"> See parameter P170
OFF	Short flashing Flash interval 1 x - 1 s pause	System error, internal program sequence interrupted <ul style="list-style-type: none"> EMC interference (observe the wiring guidelines!) Bus interface defective

Digital input LEDs

LED (green)	Display		Meaning
D1	ON		"High" potential present at terminal "C1".
		OFF	"Low" potential present at terminal "C1".
D2	ON		"High" potential present at terminal "C2".
		OFF	"Low" potential present at terminal "C2".

Error messages

Error messages from the bus interface - current or archived message relating to the last fault - can be read out via module parameter **P170**. The error messages are lost if the bus interface is switched off.

Error	Meaning	Remarks
100.0	EEPROM error	EMC faults, bus interface defective
101.0	System bus 24 V missing	No 24 V voltage on bus, connections not correct
102.0	Bus timeout P151	By means of timeout supervision parameter P151/P513
103.0	System bus BUS OFF	No 24 V supply to the bus, connections not correct
511.0	CANopen BUS OFF	Bus subscriber not connected to bus
511.1	CANopen warning	Bus error
511.2	CANopen overrun	Message buffer of bus interface overwritten with new telegram before processing
511.3	Invalid CANopen address	Incorrect/duplicated bus address
512.0	CANopen timeout	Telegram transfer error

Bus interface-related errors are depicted as follows in the error memory of the frequency inverter (**P700 / P701**).

Error (E010)	Meaning	Remarks
10.2	External bus interface telegram timeout	Telegram transfer error <ul style="list-style-type: none"> • Check the connections and links, program sequence and Bus Master.
10.3	Timeout by P151/P513	Telegram transfer error. <ul style="list-style-type: none"> • Check watchdog time (P151). • Check the connections and links and the program sequence in the Bus Master. The release bit is missing in the control word.
10.4	External bus interface initialisation error	Unable to address bus interface. <ul style="list-style-type: none"> • Check parameter P746 setting. • Check power supply of bus interface. • Check the connections and links.
10.8	External bus interface communication error	Only SK TU3-CAO bus interface: Connection between bus interface and frequency inverter interrupted.
10.9	Missing bus interface	Bus interfaces SK CU4-DEV and SK TU4-DEV only: Connection between bus interface and frequency inverter interrupted (see setting of parameter P120).

Parameters

Frequency inverter: The following frequency inverter parameters must be adapted for setting up communication between the frequency inverter and the bus interface (for details please refer to the frequency inverter manual).



Parameter [-Array]	Meaning	Remarks	
P120 [-01]	Option monitoring	"Auto" (default setting)	Only SK xU4
P509	Source Control Word	SK TU3-... on SK 5xxE: "Ethernet TU" SK xU4-... on SK 180/SK 2xxE: "System bus"	
P510 [-01]...[-02]	Setpoint source	"Auto" (default setting)	
P513	Time-out	Monitoring of the SK TU3 bus interface	Only SK 5xxE
P543 [-01]...[-03] (-05) and P543...P545	Bus actual value (1...3 (...5))	Possible settings according to P418	
P546 [-01]...[-03] (-05) and P546...P548	Bus setpoint value (1...3 (...5))	Possible settings according to P400	
P700 [-01]/P701	Current/last faults	Information parameter	
P740/P741	Process data bus In / Out	Information parameter	
P745	Module version	Information parameter	Only SK TU3
P746	Module status	Information parameter	Only SK TU3
P748	CANopen/System bus status	Information parameter	

Bus interface: The bus interface provides a selection of appropriate parameters for setting or displaying special operating values. Parameters can be adapted using the NORDCON software or an SK PAR-3H / -3E parameter box. All parameters can still be read and written by the bus master via DeviceNet.

Parameter [-Array]	Meaning	Remarks	
P150	Set relays	Set DOUT directly or control via BUS	
P151	External bus time-out	Monitoring of SK xU4 bus interface	
P152	Factory setting	Reset bus interface parameters	
P153 [-01]...[-02]	Minimum system bus cycle	Reduction of bus load on the system bus caused by the bus interface	
P154 [-01]...[-02]	Access to option card I/O	Administration of read and write rights to the IO of the module	
P160	Assembly selection	Assignment if instances of the assembly object (frequency inverter and bus interface)	
P161 [-01]...[-02]	Config PZD BusBG	Determine length of process data for the bus interface	
P162 [-01]...[-03]	Config PZD FU1	Determine length of process data for frequency inverter FI1	
P163 [-01]...[-03]	Config PZD FU2	Determine length of process data for frequency inverter FI2	
P164 [-01]...[-03]	Config PZD FU3	Determine length of process data for frequency inverter FI3	
P165 [-01]...[-03]	Config PZD FU4	Determine length of process data for frequency inverter FI4	
P170 [-01]...[-02]	Present errors	Display bus interface errors	
P171 [-01]...[-03]	Software version	Firmware version/Revision	
P172	Configuration	Bus interface type	
P173	Module status	Status of system bus or the connected FI	
P174	Status of digital inputs	Image of the switching status of DIN	
P175	Digital output state	Image of the switching status of DOUT	
P176 [-01]...[-17]	Process data bus In	Information parameter	
P177 [-01]...[-17]	Process data bus Out	Information parameter	
P180	DeviceNet address	Information parameter	
P181	DeviceNet baud rate	Information parameter	

Parameter access and diagnostics

The NORD CON software and optional control units such as the SK PAR-3H parameter box provide convenient access to the parameters of the bus interface and allow status information to be read out.

SK TU3-	SK TU4-	SK CU4- / SK TU4-
<p>Access via RJ12 diagnostics socket of the SK 5xxE</p> 	<p>Access via RJ12 diagnostics socket of the bus connection unit SK TI4-TU-BUS(-C)</p> 	<p>Access via RJ12 frequency inverter diagnostics socket, if connected to the bus interface via the system bus.</p> 

Further documentation and software (www.nord.com)

Software	Description
EDS-file	Device characteristics and parameters

Software	Description
NORD CON	Parametrisation and diagnostic software

Document	Description
BU 0000	Description of NORD CON software
BU 0040	Parameter box manual
BU 0180	Frequency inverter manual SK 180E, SK 190E
BU 0200	Frequency inverter manual SK 2xxE
BU 2600	DeviceNet bus communication description

Document	Description
TI 275274505	SK TIE4-M12-SYSM System bus connection expansion exit
TI 275274506	SK TIE4-M12-SYSS System bus connection expansion entrance
TI 275274515	SK TIE4-M12-CAO-OUT CANopen connection expansion output
TI 275274501	SK TIE4-M12-CAO CANopen connection expansion entrance