

SK CU4-IOE2

Part number: 275 271 007

IO extension

Only qualified electricians are allowed to install and commission the module described below. An electrician is a person who, because of their technical training and experience, has sufficient knowledge with regard to

- Switching on, switching off, isolating, earthing and marking power circuits and devices,
- Proper maintenance and use of protective devices in accordance with defined safety standards.

DANGER

Danger of electric shock

The frequency inverter carries hazardous voltage for up to 5 minutes after being switched off.

- Work must not be carried out unless the frequency inverter has been disconnected from the voltage and at least 5 minutes has elapsed since the mains was switched off!

NOTICE

Validity of document

This document is only valid in conjunction with the operating instructions of the respective frequency inverter ( See overview at end of document). Safe commissioning of this module and the frequency inverter depends on the availability of this information.

Scope of delivery

1 x	Module	SK CU4-IOE2
1 x	System bus cable set	grey / black
1 x	24 VDC cable set	brown / blue
2 x	Connecting screws	M4 x 20, cross-head



Usage area

IO extension for installation in decentralised frequency inverters (**SK 1x0E / SK 2xxE**). These are connected to the unit via the system bus. There are 2 digital inputs (optionally as digital outputs), 2 analogue inputs (optionally as digital inputs), and 2 analogue outputs. Only one **SK CU4-IOE2(-C)** module can be used on the frequency inverter. The module requires the following firmware version of the frequency inverter.

Model series		Firmware version
NORDAC <i>BASE</i>	SK 1x0E	≥ 1.2 R0
NORDAC <i>FLEX</i>	SK 2xxE	≥ 2.1 R0
NORDAC <i>LINK</i>	SK 2xxE-FDS	≥ 1.0 R0

Technical Information / Datasheet	SK CU4-IOE2			
IO-Extension	TI 275271007	V 1.3	4517	en

Technical Data

Temperature range	-25 °C ... 50 °C
Temperature class	Class 3K3
Protection class	IP20



Vibration resistance	3M7
Firmware version	V1.3 R0

Name	Terminal	Data
Module power supply (load capacity)	40 + 44	24 VDC ± 20 %, reverse polarity protected (≤ 2 A)
Module current draw	40 + 44	≈ 110 mA
Digital input - operating range	C3/C4	PLC compatible in accordance with EN 61131-2 (digital inputs type 1), Low: 0 .. 5 V, High: 15 V .. 30 V, voltage-proof up to 50 V
Digital input - specific data	C3/C4	R _i = 8.1 kΩ, input capacitance: 10 nF Scan rate 1 ms, response time 1 ms
Digital output - operating range	C3/C4	PLC compatible in accordance with EN 61131-2, Low: 0 V, High: 24 V, maximum permissible current per output 500 mA
Digital input - operating range	14/16	High: 7.5 V ... 30 V
Analogue input - operating range	14/16	Resolution: 12 Bit, precision: 0.1 V, voltage-proof up to 30 V, hardware filter with limit frequency of 5 kHz, Load resistance 250 Ω (Connection via DIP switch when configuration as a current input.)
Analogue input - load capacity	14/16	≤ 10 mA (mode: 0/2 ... 10 V) ≤ 20 mA (mode: 0/4 ... 20 mA)
Analogue output - load capacity	17/18	≥ 1 kΩ (Mode: 0/2 ... 10 V) ≤ 250 Ω (Mode: 0/4 ... 20 mA)
Analogue output - specific data	17/18	Resolution: 10 Bit, precision: 0.25 V short circuit-proof

Installation

Installation location	Within the connection unit of a frequency inverter (SK 180E, SK 190E, 2xxE)
Fastening	with screw fastenings

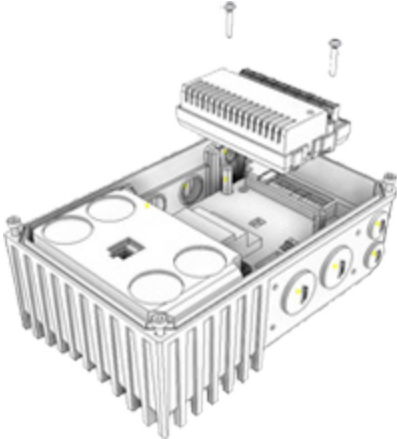
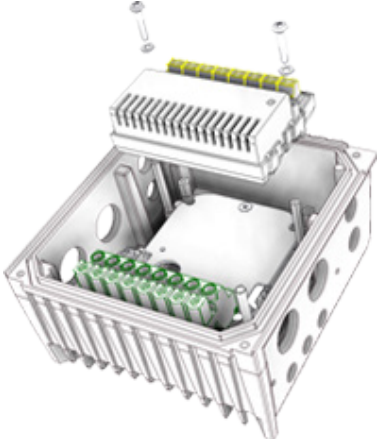
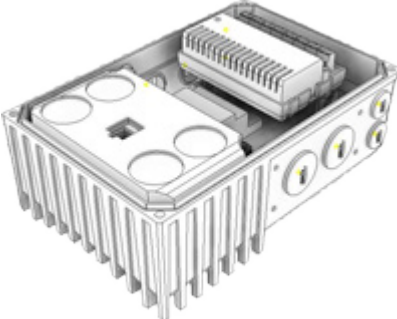
Installation steps

	SK 1xxE	SK 2xxE
1.		
2.		

Connections

Terminals	Screw terminals	1 terminal bar with 16 connections, (5 mm spacing)
Cable cross section	0.14...2.5 mm	AWG 14-26
PE connection	Via inverter	Via screws for installation in the inverter

Level	Contact	Designation	Description
System bus level, digital signals	44	VI 24V	Supply voltage (+24 V - in)***
	40	GND/0 V	Reference potential (0 V / GND)
	77	SYS+	System bus data line +**
	78	SYS-	System bus data line -**
	44	VI 24 V	Supply voltage (+24 V - in)***
	44	VI 24 V	Supply voltage (+24 V - in)***
	C3	DIN1/DOUT1	Digital input 1/digital output 1
	C4	DIN2/DOUT2	Digital input 2/digital output 2
	40	GND/0 V	Reference potential (0 V / GND)
	40	GND/0 V	Reference potential (0 V / GND)
Analogue signals	14	AIN1/DIN3	Analogue input 1/digital input 3
	16	AIN2/DIN4	Analogue input 2/digital input 4
	12	AGND/0 V	Analogue Ground (connected to terminal 40 internally)*
	17	AOUT1	Analog output 1
	18	AOUT2	Analog output 2
	12	AGND/0 V	Analogue Ground (connected to terminal 40 internally)*



* AGND/0 V is internally connected via special components to reference potential GND/0 V of the module. The two contacts must not be short-circuited in order to prevent damage to the module or interference to the analogue signals.
 ** Use "system bus" cable set (scope of supply), black = SYS +, grey= SYS -
 *** Use 24 VDC cable set (scope of supply), brown = 24 V, blue = GND/0 V

Connection examples

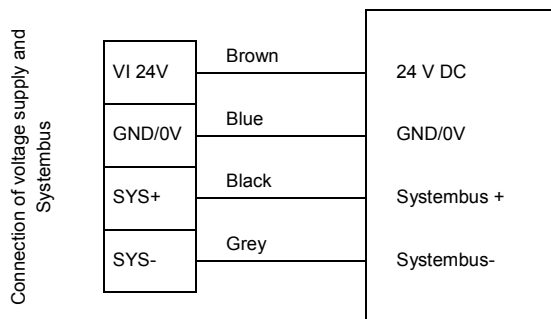

bus module

Configuration

Configuration of the module is mainly performed via the DIP switches. The DIP switches are read after a "power on" of the module. A change to the DIP switch during operation has no effect.

The system bus must be terminated at both of its physical ends (if necessary set the "System bus termination resistor" DIP switch).



Note

Broadcast mode

In "Broadcast mode, which is activated via the parameter (**P162**), the module can access up to 4 inverters in parallel. Therefore the frequency inverters jointly access the I/Os and evaluate the input signals according to their own parameterisation. Output signals from the frequency inverters which are sent to the common IO module are linked by a logical "OR" within the module. i.e. a digital output is set as soon as one of the four frequency inverters addresses it. In addition, the highest analog value is provided via the analog output of the IO extension.

DIP switches

Function	DIP-Switch Meaning (DIP-No.)	DIP-Switch Combinations			Assignment Signal
			BIT1	BIT0	
System bus termination resistor	S-Bus Term. (01)			0 1	not set setting
Addressing system bus	S-Bus Adr. Bit 0 (02)		0 0	0 1	Adr. 20 (for FI 0 Adr. 32) Adr. 21 (for FI 1 Adr. 34)
	S-Bus Adr. Bit 1 (03)		1 1	0 1	Adr. 22 (for FI 2 Adr. 36) Adr. 23 (for FI 3 Adr. 38)
Analog input AIN1	Ain1 Mode Bit 0 (04)		0 0	0 1	0 ... 10 V 2 ... 10 V
	Ain1 Mode Bit 1 (05)		1 1	0 1	0 ... 20 mA 4 ... 20 mA
Analog input AIN2	Ain2 Mode Bit 0 (06)		0 0	0 1	0 ... 10 V 2 ... 10 V
	Ain2 Mode Bit 1 (07)		1 1	0 1	0 ... 20 mA 4 ... 20 mA
Analog output AOUT1	Aout Mode Bit 0 (08)		0 0	0 1	0 ... 10 V 2 ... 10 V
	Aout Mode Bit 1 (09)		1 1	0 1	0 ... 20 mA 4 ... 20 mA
Analog output AOUT2	Aout Mode Bit 0 (10)		0 0	0 1	0 ... 10 V 2 ... 10 V
	Aout Mode Bit 1 (11)		1 1	0 1	0 ... 20 mA 4 ... 20 mA
no function	-- (12)				

LED Displays

DS (Device State)	DE (Device Error)	Meaning
		Long flashing = 0.5 s on / 1 s off Short flashing = 0.25 s on / 1 s off
OFF	OFF	Technology unit not ready, no control voltage
ON	OFF	Technology unit ready, no error, at least one frequency inverter is communicating via the system bus
ON	Short flashing	Technology unit ready, however <ul style="list-style-type: none"> One or more of the connected frequency inverters is in fault status
Long flashing	OFF	Technology unit ready and at least one further participant is connected to the system bus, but <ul style="list-style-type: none"> No frequency inverter on the system bus (or connection interrupted) Address error for one or more system bus participants
Long flashing	Short flashing Flash interval 1 x - 1s pause	System bus is in status "Bus Warning" <ul style="list-style-type: none"> Communication on system bus interrupted or No other participant present on the system bus
Long flashing	Short flashing Flash interval 2 x - 1s pause	<ul style="list-style-type: none"> System bus is in status "Bus off" or The system bus 24V power supply was interrupted during operation
Long flashing	Short flashing Flash interval 3 x - 1s pause	<ul style="list-style-type: none"> No system bus 24V power supply (system bus is in status "Bus off")
Long flashing	Short flashing Flash interval 4 x - 1s pause	Module error <ul style="list-style-type: none"> EEPROM error
Long flashing	Short flashing Flash interval 5 x - 1s pause	Module error <ul style="list-style-type: none"> AOUT error (analog output) DIP switch configuration error
OFF	Short flashing Flash interval 1...7 - 1s pause	System error, internal program sequence interrupted <ul style="list-style-type: none"> EMC interference (observe wiring guidelines!) Module faulty

IO channel	Display	Meaning
DI 1	ON	High potential DIN1
DI 2	ON	High potential DIN2
DI 3	ON	High potential DIN3
DI 4	ON	High potential DIN4

IO channel	Display	Meaning
DO 1	ON	High potential DOUT1
DO 2	ON	High potential DOUT2

DI 3/4, DO 1/2 Available according to the type of IO module

Error messages

Error messages for the module - the present or archived messages for the last error - can be read out via the module parameter (P170).

Error	Meaning	Comments
1000	EEPROM error	EMC fault, module defective
1030	System bus OFF	No 24 V supply to bus, connections not correct
2000	DIP switch changed	DIP switch configuration changed during operation
2001	DIP switch configuration incorrect	Invalid DIP switch settings
2010	Error at analog output	Overload, reference voltage, short-circuit, calibration error
2020	Inverter does not support the module	Incorrect inverter type connected

Parameterisation

Inverter: In order to establish communication between the inverter and the IOE module, the following inverter parameters must be changed.

Parameter	Meaning	Comments
(P514)	Bus speed	5 (= 250 kBaud)
(P515 [-01])	Bus address	FI 1 = 32 FI 2 = 34 FI 3 = 36 FI 4 = 38
(P480 [-01 ...])	DIN function of the device	Possible settings according to (P420)
(P481 [-05 ...])	DOU function of the device	Possible settings according to (P434)
(P400 [-03 ...])	AIN function of the device	Possible settings according to (P400)
(P418 [-01 ...])	AUT function of the device	Possible settings according to (P418)

IO extension: The module provides a selection of parameters for setting or displaying special operating values. The parameters can be changed with the aid of the NORD CON-software or with a ParameterBox. Communication is only possible via an SK 54xE, SK 2xxE or SK 1x0E which is connected to the module.

Parameter	Meaning	Comments
(P150)	Set relays	Set DOU directly or control via BUS
(P152)	Factory setting	Reset the module parameters, calibrate AOUI
(P153 [-01 ...])	Minimum system bus cycle	Reduction of bus load due to the module
(P160 [-01 ...])	Set analog output	Set AOUI directly or control via BUS
(P161 [-01 ...])	Filter time	Debounce or round input signals
(P162)	Send broadcast	Activate Broadcast mode (control of several inverters by this module)
(P163 [-01 ...])	Invert analog output	Invert analog signal
(P170 [-01 ...])	Present errors	Display of module errors
(P171 [-01 ...])	Software version	Firmware version / Revision
(P172)	Configuration	Module type
(P173)	Module status	Status of system bus or connected FI
(P174)	Status of digital inputs	Display of DIN switching status
(P175)	Relay status	Display of DOU switching status
(P176 [-01 ...])	Actual voltage	Voltage level of analog signals

Further documentation and software (www.nord.com)

Software	Name
NORD CON	Parameterisation and diagnostic software

Software	Name

Document	Name
BU 0000	Description of NORD CON software
BU 0040	ParameterBox manual
BU 0180	Frequency inverter manual SK 180E, SK 190E

Document	Name
BU 0200	Frequency inverter manual SK 2xxE
BU 0250	Frequency inverter manual SK 2xxE-FDS
BU 0505	Frequency inverter manual SK 54xE

Description of parameters

P150		Set relays	
Setting range	0 ... 4	Other applicable parameter(s) P480	
Factory setting	{ 0 }		
Scope of Application	SK CU4-IOE2, SK TU4-IOE, SK EBIOE-2		
Description	Sets the switching states of the digital outputs		
Setting values	Value	Meaning	
	0	Via bus	Control of all digital outputs via the system bus; the functions are defined in the frequency inverter (P480).
	1	Outputs OFF	All digital outputs are Off (Low = 0 V).
	2	Output 1 ON (DO1)	The digital output DO1 is set to "High" (active); digital output DO2 remains switched off.
	3	Output 2 ON (DO2)	The digital output DO2 is set to "High" (active); digital output DO1 remains switched off.
	4	Outputs 1 and 2 ON	All digital outputs are on (High)
P152		Factory setting	
Setting range	0 ... 2		
Factory setting	{ 0 }		
Description	Resets the module parameters to the factory settings.		
Note	On completion of this process the parameter display changes back to the value "0"		
Setting values	Value	Meaning	
	0	No change	This function is not implemented.
	1	Load factory setting	All parameters are reset to the factory settings.
	2	Calibration AOUT	The accuracy of the analog output can be improved with a correction line, however, this is not activated as standard. If factory settings (P152 ={ 1 }) are loaded, the correction values are retained. A calibration is carried out if (P152) is set to { 2 }, i.e. the line is re-recorded and stored in the EEPROM.
P153		Minimum system bus cycle	
Setting range	5 ... 250 ms		
Arrays	[-01] = TxSDO Inhibit Time	[-02] = TxPDO Inhibit time	
Factory setting	{ [-01] = 10 }	{ [-02] = 5 }	
Description	Adjusts the cycle time for transmission of SDOs (Service Data Objects) and PDOs (Process Data Object) on the system bus.		
Note	Increasing the cycle time reduces the bus load		

P160		Set analog output	
Setting range	-0,1 ... 10,0 V		
Arrays	[-01] = Analog output 1		[-02] = Analog output 2
Factory setting	{ [-01] = -0.1 }		{ [-02] = -0.1 }
Description	Sets the signal to a defined value, independent of the system bus.		
Note	<p>If the analog output is configured as an output for current values, the factor 2 must be considered.</p> <p>The setting 0 V corresponds in this case to a current value of 0 mA ($0 \times 2 = 0$).</p> <p>The setting 10 V corresponds in this case to a current value of 20 mA ($10 \times 2 = 20$).</p> <p>The arrays are only functional if the corresponding IOs are present in the module.</p>		
Setting values	Value	Meaning	
	-0.1	The value is set via Bus	
	0.0 ... 10.0	The value is set manually	
P161		Filter time	
Setting range	0 ... 400 ms		
Arrays	[-01] = Analog input 1		[-02] = Analog input 2
	[-03] = Analog output 1		[-04] = Digital input 1
	[-05] = Digital input 2		[-06] = Digital input 3
	[-07] = Digital input 4		[-08] = Digital output 1
	[-09] = Digital output 2		[-10] = Analog output 2
Factory setting	{ [-01], [-02] = 100 }		{ [-04] ... [-07] = 2 } { [-03], [-08] ... [-10] = 0 }
Description	<p>The analog and digital inputs are read cyclically every 250 μs, which results in an input uncertainty of 0.25ms. In order to eliminate bounce and smooth the input signals, the information which is read in is passed through a filter routine. The filter time can be parametrised.</p> <p>For example, if a filter time of 1 ms is parametrised for a digital input, the input signal is delayed by approx. 1...1.25ms.</p> <p>The parameterisation of the filter time for the analog outputs is used to round off signal jumps.</p>		
Note	The arrays are only functional if the corresponding IOs are present in the module.		
P162		Send broadcast	
Setting range	0 ... 1		
Factory setting	{ 0 }		
Description	<p>Activates the broadcast mode.</p> <p>In broadcast mode, up to four frequency inverters can access the module simultaneously.</p>		
Note	<p>In broadcast mode, the addressing of the module (DIP switches) is no longer taken into account.</p> <p>The received data are linked in the I/O module using OR logic. If several frequency inverters are linked to the digital outputs of the module, the relevant output is set to "High" as soon as it is accessed by a frequency inverter. The analog outputs behave in a similar manner. Here, the highest value has priority.</p>		
Setting values	0 = Off		1 = On (broadcast mode active)

P163	AOut Inverse									
Setting range	0 ... 1									
Arrays	[-01] = Analog output 1	[-02] = Analog output 2								
Factory setting	{ 0 }									
Description	<p>Inverts the signal at the analog output. In other words, for values that come over the system bus (either from the frequency inverter (parameter P542) or from a PLC), the direction of action of the analog output is reversed. However, this does not apply if the analogue output is set by parameter P160.</p> <p>Example</p> <table border="1" data-bbox="509 555 1329 696"> <thead> <tr> <th>Value via system bus (from P542)</th> <th>Value at AOUT if P163 = 1</th> </tr> </thead> <tbody> <tr> <td>10 V</td> <td>0 V</td> </tr> <tr> <td>2 V</td> <td>8 V</td> </tr> <tr> <td>0 V</td> <td>10 V</td> </tr> </tbody> </table>		Value via system bus (from P542)	Value at AOUT if P163 = 1	10 V	0 V	2 V	8 V	0 V	10 V
Value via system bus (from P542)	Value at AOUT if P163 = 1									
10 V	0 V									
2 V	8 V									
0 V	10 V									
Note	The arrays are only functional if the corresponding IOs are present in the module.									
Setting values	0 = Off	1 = On (inversion active)								

P170	Actual error	
Display range	0 ... 2020	
Arrays	[-01] = Actual error	Active error message (not acknowledged)
	[-02] = Last fault	Displays the last error message from the error memory
Description	Displays an error message.	
Note	SK CSX-3... The display is encoded SK PAR-3... The display is in plain text	
Display values	 Section "Error messages"	

P171	Software version	
Display range	0.0 ... 9999.0	
Arrays	[-01] = Software version	Version number (e.g.: V1.0)
	[-02] = Software revision	Revision number (e.g.: R1)
	[-03] = Special version	Special version of the hardware/software (e.g: 0.0). The value "0" stands for "Standard Version".
Description	Displays the software version (firmware version) of the module	

P172	Configuration	
Display range	0 ... 8	
Description	Displays the configuration / version of the device	
Display values	Value	Meaning
	0	CU4 (internal) Module type: SK CU4-...
	1	TU4 (external) Module type: SK TU4-...
	2	TU1-3 (Techn. Unit) Module type: SK TU1- / TU2- / TU3- ...
	3	TU1-3 (Techn. Unit)+DIP Module type: SK TU1- / TU2- / TU3- ... with DIP-switches
	4	EBIOE-2 Module type: SK EBIOE-2
	5	TU4 Safe Module type: SK TU4-... / "Safe" version
	6	TU3 Safe Module type: SK TU3-... / "Safe" version
	7	CU4-IOE2 Module type: SK CU4-IOE2-...

P173		Option status	
Display range	0000 ... FFFF <small>(hex)</small>		
Description	Displays the status of the connected devices and the system bus		
Note	SK CSX-3... The display is in hexadecimal format SK PAR-3... The display is in binary format		
Display values	Value (Bit)	Meaning	
	0 ... 5	Not used	
	6	BUS WARNING	System bus is in status "BUS WARNING"
	7	BUS OFF	System bus is in status "BUS OFF"
	8	FI 1 (Low – Bit)	FI 1 status (low Bit)
	9	FI 1 (High – Bit)	FI 1 status (High Bit)
	10	... 11	FI 2 status
	12	... 13	FI 3 status
	14	... 15	FI 4 status

Bit High	Bit Low	Meaning
0	0	FI is offline
0	1	FI is not recognised
1	0	FI is online
1	1	FI lost

* FI is switched off

P174		Status of digital in.	
Display range	0000 ... 1111 <small>(bin)</small>		
Description	Actual image of the switching states of the digital inputs.		
Note	SK CSX-3... The display is in hexadecimal format SK PAR-3... The display is in binary format		
Display values	Value (Bit)	Meaning	
	0	Digital input 1	Digital input 1 of the module
	1	Digital input 2	Digital input 2 of the module
	2	Digital input 3	Digital input 3 of the module
	3	Digital input 4	Digital input 4 of the module

P175		State of relays	
Display range	00 ... 11 <small>(bin)</small>		
Description	Actual image of the switching states of the digital outputs.		
Note	SK CSX-3... The display is in hexadecimal format SK PAR-3... The display is in binary format		
Display values	Value (Bit)	Meaning	
	0	Relay 1	Digital output 1 of the module
	1	Relay 2	Digital output 2 of the module

P176		Current voltage	
Display range	-100,0 ... 100,0 %		
Arrays	[-01] = Analog input 1	[-02] = Analog input 2	
	[-03] = Analog output 1	[-04] = Analog output 2	
Description	Shows the measured voltage.		