

## SK CU4-PNT

Part number: 275 271 015

### PROFINET IO® – Internal Bus Interface

The bus interface may only be installed and commissioned by qualified electricians. An electrician is a person who, because of their technical training and experience, has sufficient knowledge with regard to

- Switching on, switching off, isolating, earthing and marking power circuits and devices,
- Proper maintenance and use of protective devices in accordance with defined safety standards.

### DANGER

#### Danger of electric shock

The frequency inverter carries hazardous voltage for up to 5 minutes after being switched off.

- Work must not be carried out unless the frequency inverter has been disconnected from the voltage and at least 5 minutes has elapsed since the mains was switched off!

### NOTICE

#### Validity of document

This document is only valid in conjunction with the operating instructions of the respective frequency inverter and the bus communication manual for this bus interface (📖 See overview at end of document). These documents contain all of the information that is required for safe commissioning of the bus interface module and the frequency inverter.

#### Scope of delivery

1 x	Bus interface	SK CU4-PNT
1 x	System bus cable set	grey/black
1 x	24 VDC cable set	brown/blue
2 x	Connecting screws	M4 x 20, cross-head



#### Usage area

Internal interface for the connection of a decentralised frequency inverter (SK 180E...SK 2xxE) to a **PROFINET IO** field bus. This is connected to the inverter via the system bus, and can directly access up to 4 frequency inverters. 2 digital inputs are available.

Technical Information / Datasheet	SK CU4-PNT			
PROFINET IO Bus module	TI 275271015	V 1.4	3517	en

## Technical Data

### Bus interface

Temperature range	-25 °C ... xx °C *	Vibration resistance	3M7
Temperature class	Class 3K3	Firmware version	V1.4 R4
Protection class	IP20	Supply voltage	24 V ± 20 %, ≈ 100 mA reverse polarity protected

\* The upper temperature limit depends on the frequency inverter and the operating mode → see "Derating"

Digital input - working range	Low: 0 V ... 5 V, High: 15 V ... 30 V
Digital input - specific data	R <sub>i</sub> = 10 kΩ, input capacity: 10 nF, response time 10 ms, inputs as per EN 61131-2 type 1

### Bus specification

PROFINET IO	max. 100 MBaud	Cable	Min. Ethernet CAT-5
	electrical isolation 500 V <sub>eff</sub>	Max. cable length	100 m between two bus interfaces
Bus connection	Screw terminals	Shield	Direct to PE
Bus termination	performed automatically	PE connection	via PE screw cap in terminal box
Status display	6 LEDs		
Topology	Star, tree, ring, line		

### Power

Update interval for process data between bus interface and frequency inverter	≈ 5 ms
Parameter read access on the frequency inverter	≈ 25 ms
Parameter write access with storage in EEPROM	≈ 70 ms
Cycle times	≥ 1 ms

## Derating

### NOTICE

### Derating

Depending on the installation location of the bus interface (SK 180E, SK 190E or SK 2xxE), the operating mode (S1, S3 ...) and the installation type (wall-mounting, motor-mounting) of the frequency inverter and the type of motor used (IE1 / IE2 / ...), restrictions to the permissible ambient temperature must be taken into consideration. If the permissible ambient temperature is exceeded, the bus interface can heat up to an impermissible extent and switch itself off with an error message (E104.0).

Operating mode	Installation type	Maximum ambient temperature *	
		SK 180E/SK 190E	SK 2xxE
S1	Motor	25 °C	27 °C
S3 ED 50 %, 10 min	Motor	40 °C	Not applicable
S3 ED 60 %, 10 min	Motor	Not applicable	40 °C
S1	Wall (unventilated)	37 °C	39 °C
S1	Wall (ventilated)	47 °C	45 °C

\* The limits of the frequency inverter must not be exceeded (refer to the frequency inverter manual).



**Bus interface characteristics**

Communication	RT (Real Time) → Real time communication of process data
	IRT (Isochronous Real Time) → Isochronous real time communication of synchronised process data
Addressing PROFINET IO	Automatic address assignment via IO controller using DCP (Discovery Configuration Protocol)
Data transfer	via Switched Ethernet
Autonegotiation	Negotiation of transfer parameters
Autocrossover	Transmission and receiver cables are automatically crossed in the switch as necessary
Conformity classes	CC-B and CC-C
Access for NORD diagnosis tool via	<ul style="list-style-type: none"> <li>• Diagnostics socket on the device (if available) and via frequency inverter</li> <li>• Ethernet protocols UDP or TCP/IP possible</li> </ul>

**Installation**

Installation location	Within the connection unit of a frequency inverter (SK 180E, SK 190E, 2xxE)
Fastening	with screw fastenings

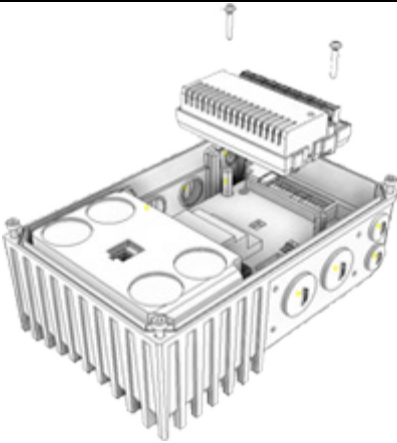
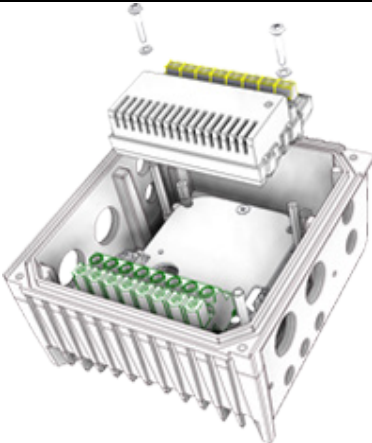
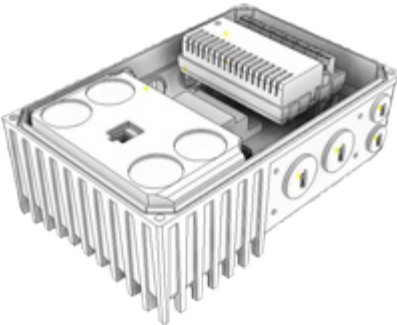
**Installation steps**

	SK 1xxE	SK 2xxE
1.		
2.		

### Connections

Connection is via the terminal strip of the bus interface.

Potential	Contact	Designation	Description	
1	Ethernet	E8	PHY1 RX-	Ethernet connection 2 Receive Data -
		E7	PHY1 RX+	Ethernet connection 2 Receive Data +
		E6	PHY1 TX-	Ethernet connection 2 Transmission Data -
		E5	PHY1 TX+	Ethernet connection 2 Transmission Data +
		E4	PHY0 RX-	Ethernet connection 1 Receive Data -
		E3	PHY0 RX+	Ethernet connection 1 Receive Data +
		E2	PHY0 TX-	Ethernet connection 1 Transmission Data -
		E1	PHY0 TX+	Ethernet connection 1 Transmission Data +
2	System bus level and digital inputs	78	SYS -	System bus data line -
		77	SYS +	System bus data line +
		C1	DIN1	Digital input 1
		C2	DIN2	Digital input 2
		40	GND/0V	Reference potential (0 V/GND)
		44	24 V	Supply voltage (+24 V)
		40	GND/0V	Reference potential (0 V/GND)
		44	24 V	Supply voltage (+24 V)

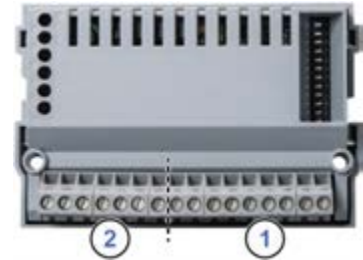

### Connection examples

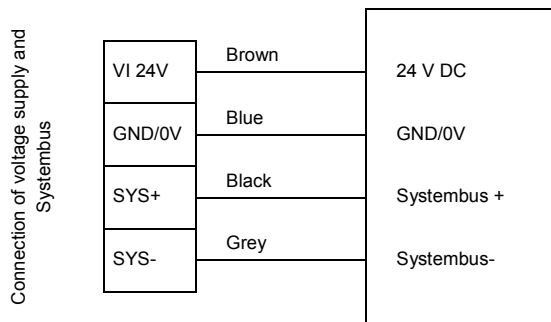

bus module

## Configuration

Configuration of the bus interface module for remote maintenance or for the system bus is carried out via the DIP switches. The DIP switch settings are read after a "Power On" of the bus interface.

DIP switch											Meaning	
12	11	10	9	8	7	6	5	4	3	2	1	
X	X	X	No function								X	
											0	System bus terminating resistor not set.
											1	System bus terminating resistor set.
Access rights for remote maintenance												
		0										Only read access to parameters possible.
		1										Read and write access to parameters possible.
		0										No control possible.
		1										Control is possible.
0												TCP/IP open connection.
1												Secure TCP/IP connection.

### 1. System bus (DIP 1)

The system bus must be terminated at both physical ends.

### 2. (DIP 2 ... 9)

No function.

### 3. Access rights for remote maintenance (DIP 10 ... 12)

The bus interface and the connected frequency inverter can be accessed using remote maintenance via the Ethernet TCP and UDP protocols. The type of access is defined via the DIP switch with inputs 10 to 12.



### LED indicators

The operating statuses of the bus interface are visualised using LED indicators.

No.	Name	Colour	Meaning
1	RUN	green	Ethernet State
	BF	red	Ethernet Error
2	L1	green	Link 1
	A1	yellow	Activity 1
3	L2	green	Link 2
	A2	yellow	Activity 2

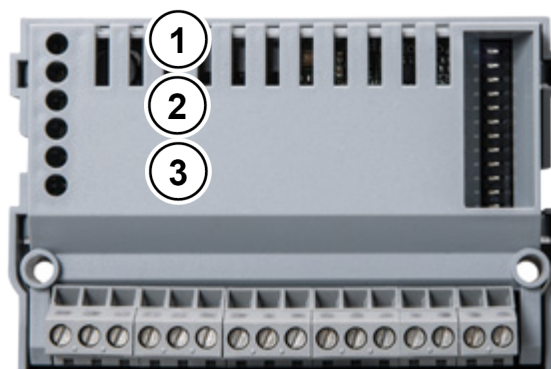

### PROFINET-specific LED

RUN (Ethernet State)	Meaning
<b>OFF</b>	No operating voltage Initialisation
<b>Flashing green</b>	No connection to PROFINET IO controller No parameter communication No process data communication
<b>Green ON</b>	Parameter communication active Process data communication active

BF (Ethernet Error)	Meaning
<b>OFF</b>	No error
<b>Flashing red</b>	No process data communication → e.g. incorrect GSDML file
<b>Red ON</b>	Ethernet error → there is no physical connection to a further subscriber
<b>Double-flashing red (2 x 0.25 s,+ 1sec pause)</b>	PROFINET or FU timeout, (see also P151, P513)

Link (Green LED)	Activity (Yellow LED)	Meaning
<b>OFF</b>	<b>OFF</b>	<ul style="list-style-type: none"> <li>• Bus interface not ready, no control voltage,</li> <li>• No bus connection (check cable connection)</li> </ul>
<b>ON</b>	<b>OFF</b>	<ul style="list-style-type: none"> <li>• Bus connection (cable connection) to another Ethernet device exists</li> <li>• No bus activity present</li> </ul>
<b>ON</b>	<b>Flashing (Blinking)</b>	<ul style="list-style-type: none"> <li>• Bus connection (cable connection) to another Ethernet device exists</li> <li>• Bus activity present</li> </ul>

## NORD-specific LEDs

DS (Device State)	EN (Device Error)	Meaning long flashing = 0.5 s on / 1 s off short flashing = 0.25 s on / 1 s off
OFF	OFF	Bus interface not ready, no control voltage
ON	OFF	Bus interface ready, no error, at least one frequency inverter is communicating via the system bus
ON	Short flashing	Bus interface ready, but <ul style="list-style-type: none"> <li>One or more of the connected frequency inverters has fault status</li> </ul>
Long flashing	OFF	Bus interface ready and at least one other subscriber is connected to the system bus, but <ul style="list-style-type: none"> <li>No frequency inverter on the system bus (or connection interrupted)</li> <li>One or more system bus subscriber has an address error</li> <li>Software incompatible (bus interface software and FI software incompatible - update required)</li> </ul>
Long flashing	Short flashing Flash interval 1 x - 1s pause	System bus is in status "Bus Warning" <ul style="list-style-type: none"> <li>Communication on system bus disrupted</li> <li>No other subscribers present on system bus</li> <li>Module not inserted correctly or no connection to system bus</li> <li>Frequency inverter has no supply voltage</li> </ul>
Long flashing	Short flashing Flash interval 2 x - 1s pause	System bus is in status "Bus Off" <ul style="list-style-type: none"> <li>The system bus 24 V power supply has been interrupted during operation</li> </ul>
Long flashing	Short flashing Flash interval 3 x - 1s pause	System bus is in status "Bus Off" <ul style="list-style-type: none"> <li>The 24V voltage supply of the system bus is missing</li> </ul>
Long flashing	Short flashing Flash interval 4 x - 1s pause	Bus interface error <ul style="list-style-type: none"> <li>See parameter <b>P170</b></li> </ul>
OFF	Short flashing Flash interval 1...7 - 1s pause	System error, internal program sequence interrupted <ul style="list-style-type: none"> <li>EMC interference (observe the wiring guidelines!)</li> <li>Bus interface defective</li> </ul>

## Error messages

Error messages from the bus interface - current or archived message relating to the last fault - can be read out via bus interface parameter **P170**. The error messages are lost if the bus interface is switched off.

Error	Meaning	Remarks
100.0	EEPROM error	EMC fault, bus interface defective
101.0	System bus 24 V missing	No 24 V voltage on bus, connections not correct
102.0	Bus timeout <b>P151</b>	By means of timeout supervision parameter <b>P151/P513</b>
103.0	System bus Off	No 24 V voltage on bus, connections not correct
104.0	Overtemp. Module	Only SK CU4-PNT bus interface (see <b>E10.7</b> )
550.0	General configuration error	No Ethernet connection (see <b>E10.5</b> )
550.1	IO hardware error	Error on IO interfaces (see <b>E10.4</b> )
550.2	CAN hardware error	EMC fault (see <b>E10.6</b> )
550.3	SAFE hardware error	Error in the safety module
550.4	FI lost	Connection to system bus participant (FI) lost
550.5	AR lost	PROFINET telegram failure, connection to the IO controller lost (see <b>E10.2</b> )
564.0	MAC address error	MAC address defective

Errors which occur in relation to the bus interface are depicted as follows in the error memory of the frequency inverter (P700 / P701).

Error (E010)	Meaning	Remarks
10.0	Connection error	<ul style="list-style-type: none"> <li>• Contact to bus interface lost</li> </ul>
10.2	PROFINET telegram failure	<ul style="list-style-type: none"> <li>• Check physical bus connections</li> <li>• Check the status of the PROFINET IO controller</li> </ul>
10.3	Timeout through <b>P151</b>	<ul style="list-style-type: none"> <li>• System bus monitoring has triggered.               <ul style="list-style-type: none"> <li>– Check time setting parameter <b>P151</b></li> </ul> </li> <li>• Telegram transfer is faulty.               <ul style="list-style-type: none"> <li>– Reception of cyclic telegrams</li> </ul> </li> <li>• Check physical bus connections</li> </ul>
10.4	Hardware error, IOs	<ul style="list-style-type: none"> <li>• An error has occurred in the IO hardware               <ul style="list-style-type: none"> <li>– Remedy EMC fault</li> <li>– Restart the bus interface</li> </ul> </li> </ul>
10.5	General PROFINET configuration error	<ul style="list-style-type: none"> <li>• No Ethernet detected at the port This error only occurs if there had previously been a connection to another IO device or switch</li> </ul>
10.6	System bus hardware error	<ul style="list-style-type: none"> <li>• Remedy EMC fault</li> </ul>
10.7	CU4 temperature too high	<i>Only SK CU4-PNT bus interface:</i> <ul style="list-style-type: none"> <li>• Excess bus interface temperature</li> </ul>
10.8	Timeout connection error	<ul style="list-style-type: none"> <li>• Connection between bus interface and frequency inverter interrupted due to timeout.</li> </ul>
10.9	Module missing <b>P120</b>	<i>Bus interfaces SK CU4-PNT and SK TU4-PNT only:</i> <ul style="list-style-type: none"> <li>• The module entered in parameter <b>P120</b> is not available.</li> </ul>



## Parameters

**Frequency inverter:** The following frequency inverter parameters must be adapted for setting up communication between the frequency inverter and the bus interface (for details please refer to the frequency inverter manual).



Parameter [-Array]	Meaning	Remarks	
P120 [-01]	Option monitoring	"Auto" (default setting)	Only SK xU4
P509	Source Control Word	SK TU3-... on SK 5xxE: "Ethernet TU" SK xU4-... on SK 180/SK 2xxE: "System bus"	
P510 [-01]...[-02]	Setpoint source	"Auto" (default setting)	
P513	Time-out	Monitoring of the SK TU3 bus interface	Only SK 5xxE
P543 [-01]...[-03] (-05) and P543...P545	Bus actual value (1...3 (...5))	Possible settings according to P418	
P546 [-01]...[-03] (-05) and P546...P548	Bus setpoint value (1...3 (...5))	Possible settings according to P400	
P700 [-01]/P701	Current/last faults	Information parameter	
P740/P741	Process data bus In / Out	Information parameter	
P745	Module version	Information parameter	Only SK TU3
P746	Module status	Information parameter	Only SK TU3
P748	CANopen/System bus status	Information parameter	

**Bus interface:** The bus interface provides a selection of appropriate parameters for setting or displaying special operating values. Parameters can be adapted using the NORDCON software or an SK PAR-3H / -3E parameter box. All parameters can still be read from and written to by the bus master via PROFINET IO.

Parameter [-Array]	Meaning	Remarks	-TU3-	-TU4-	-CU4-
P150	Set relays	Set DOUT directly or control via bus		X	
P151	External bus time-out	Monitoring of SK xU4 bus interface		X	X
P152	Factory setting	Reset bus interface parameters	X	X	X
P153 [-01 ...]	Minimum system bus cycle	Reduction of bus load on the system bus caused by the bus interface		X	X
P154 [-01 ...]	Access to option card I/O	Administration of read and write permissions to the IOs of the bus interface		X	X
P160 [-01...]	IP address		X	X	X
P161 [-01...]	IP subnet mask		X	X	X
P162	Device name	Up to 240 characters (ASCII codes 45 ... 122), save by entering "0" as the final character	X	X	X
P163 [-01 ...]	Alarm test	Sets a diagnostic alarm	X	X	X
P164 [-01 ...]	IP Gateway	IP-Address for Gateway functionality	X	X	X
P170 [-01 ...]	Present errors	Indication of a bus interface error	X	X	X
P171 [-01 ...]	Software version	Firmware version/Revision	X	X	X
P172	Configuration	Bus interface type	X	X	X
P173 [-01 ...]	Module status	Status of system bus or the connected FI	X	X	X
P174	Status of digital inputs	Image of the switching status of DIN		X	X
P175	Digital output state	Image of the switching status of DOUT		X	
P176 [-01...]	Process data bus In	Information parameter	X	X	X
P177 [-01...]	Process data bus Out	Information parameter	X	X	X
P178	Internal temperature	Information parameter			X
P180 [-01 ...]	PPO Type	Information parameter	X	X	X
P181 [-01 ...]	MAC address	Information parameter	X	X	X
P185 [-01 ...]	Present IP address	Information parameter	X	X	X
P186 [-01 ...]	Current IP subnet mask	Information parameter	X	X	X
P187 [-01 ...]	Actual IP Gateway	Information parameter	X	X	X
P190	Status DIP-switches	Information parameter	X	X	X

### Parameter access and diagnostics

The NORD CON software and optional control units such as the SK PAR-3H parameter box provide convenient access to the parameters of the bus interface and allow status information to be read out.

SK TU3-	SK TU4-	SK CU4- / SK TU4-
Access via RJ12 diagnostics socket of the SK 5xxE 	Access via RJ12 diagnostics socket of the bus connection unit <b>SK TI4-TU-BUS(-C)</b> 	Access via RJ12 frequency inverter diagnostics socket, if connected to the bus interface via the system bus. 

### Further documentation and software ([www.nord.com](http://www.nord.com))

Software	Description
<a href="#">GSDML-file</a>	Device characteristics and parameters

Software	Description
<a href="#">NORD CON</a>	Parametrisation and diagnostic software

Document	Description
<a href="#">BU 0000</a>	Description of NORD CON software
<a href="#">BU 0040</a>	Parameter box manual
<a href="#">BU 0180</a>	Frequency inverter manual SK 180E, SK 190E
<a href="#">BU 0200</a>	Frequency inverter manual SK 2xxE

Document	Description
<a href="#">BU 2400</a>	PROFINET IO bus communication manual
<a href="#">TI 275274505</a>	SK TIE4-M12-SYSM System bus connection expansion exit
<a href="#">TI 275274506</a>	SK TIE4-M12-SYSS System bus connection expansion entrance
<a href="#">TI 275274514</a>	SK TIE4-M12-SYSM Ethernet connection expansion entrance/exit