

SK CU4-ECT-C

Part number: 275 271 517

EtherCAT® – Internal Bus Interface

The bus interface may only be installed and commissioned by qualified electricians. An electrician is a person who, because of their technical training and experience, has sufficient knowledge with regard to

- Switching on, switching off, isolating, earthing and marking power circuits and devices,
- Proper maintenance and use of protective devices in accordance with defined safety standards.

DANGER

Danger of electric shock

The frequency inverter carries hazardous voltage for up to 5 minutes after being switched off.

- Work must not be carried out unless the frequency inverter has been disconnected from the voltage and at least 5 minutes has elapsed since the mains was switched off!

NOTICE

Validity of document

This document is only valid in conjunction with the operating instructions of the respective frequency inverter and the bus communication manual for this bus interface (📖 See overview at end of document). These documents contain all of the information that is required for safe commissioning of the bus interface module and the frequency inverter.

Scope of delivery

1 x	Bus interface	SK CU4-ECT-C
1 x	System bus cable set	grey/black
1 x	24 VDC cable set	brown/blue
2 x	Connecting screws	M4 x 20, cross-head



Usage area

Internal interface for connecting a decentralised frequency inverter (SK 180E...SK 2xxE) to an **EtherCAT** field bus. This is connected to the inverter via the system bus, and can directly access up to 4 frequency inverters. 2 digital inputs are available. The bus interface has a water-repellent coating. Reliable operation is retained even with condensation.

Technical Information / Datasheet	SK CU4-ECT-C			
EtherCAT Bus module	TI 275271517	V 1.2	0217	EN

Technical Data

Bus interface

Temperature range	-25 °C ... xx °C *	Vibration resistance	3M7
Temperature class	Class 3K3	Firmware version	V1.8 R0
Protection class	IP20	Supply voltage	24 V ± 20 %, ≈ 100 mA Reverse polarity protected

* The upper temperature limit depends on the frequency inverter and the operating mode → see "Derating"

Digital input - working range	Low: 0 V ... 5 V, High: 15 V ... 30 V
Digital input - specific data	R _i = 10 kΩ, input capacity: 10 nF, response time 1 ms, inputs as per EN 61131-2 type 1

Bus specification

EtherCAT	max. 100 MBaud	Cable	Min. Ethernet CAT-5
	electrical isolation 500 V _{eff}	Max. cable length	100 m between two bus interfaces
Bus connection	Screw terminals	Shield	Direct to PE
Bus termination	performed automatically	PE connection	via PE screw cap in terminal box
Status display	6 LEDs		
Topology	Linear bus		
Process data	8 bytes per FI + 2 bytes for IOs. Total length 2 ... 34 Bytes		

Power

Update interval of process data for 1000 devices	≈ 1 ms
Update interval for process data between bus interface and frequency inverter	≈ 5 ms
Parameter read access on the frequency inverter	≈ 12 ms
Parameter write access with storage in EEPROM	≈ 25 ms

Derating

NOTICE

Derating

Depending on the installation location of the bus interface (SK 180E, SK 190E or SK 2xxE), the operating mode (S1, S3 ...) and the installation type (wall-mounting, motor-mounting) of the frequency inverter as well as the type of motor used (IE1 / IE2 / ...), restrictions to the permissible ambient temperature must be taken into account. If the permissible ambient temperature is exceeded, the bus interface can heat up to an impermissible extent and switch itself off with an error message (E104.0).

Operating mode	Installation type	Maximum ambient temperature *	
		SK 180E/SK 190E	SK 2xxE
S1	Motor	25 °C	30 °C
S3 ED 50 %, 10min	Motor	40 °C	Not applicable
S3 ED 70 %, 10min	Motor	Not applicable	40 °C
S1	Wall (unventilated)	37 °C	42 °C
S1	Wall (ventilated)	47 °C	48 °C

* The limits of the frequency inverter must not be exceeded (please refer to the frequency inverter manual).



Bus interface characteristics

Parametrisation	via CoE (CANopen over EtherCat)
Error Messages (Emergency Messages)	in acc. with CANopen DS-301
EtherCAT Addressing (Second Address)	DIP switch or bus interface parameters
Distributed Clocks	not supported
Access for NORD diagnosis tool via	diagnosis socket on the device (if available) and via frequency inverter

Installation

Installation location	Within the connection unit of a frequency inverter (SK 180E, SK 190E, 2xxE)
Fastening	with screw fastenings

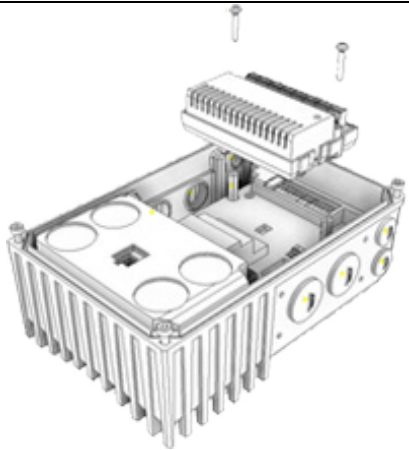
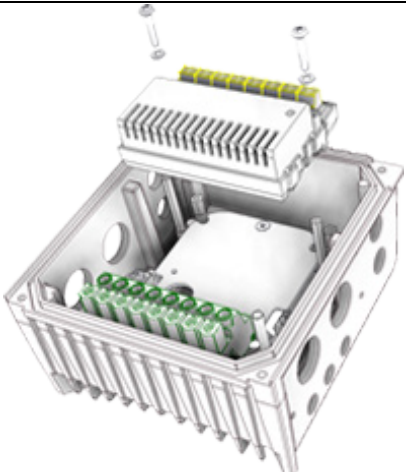
Installation steps

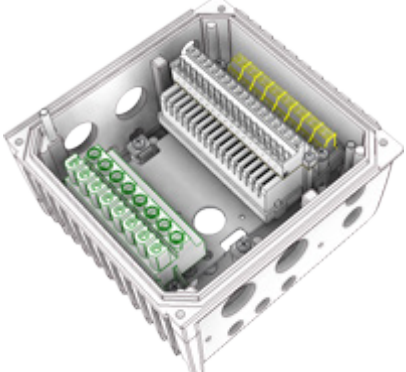
	SK 1xxE	SK 2xxE
1.		
2.		

Connections

Connection is via the terminal strip of the bus interface.

Potential	Contact	Designation	Description	
1	Ethernet	E8	PHY1 RX-	Ethernet connection 1 Receive Data -
		E7	PHY1 RX+	Ethernet connection 1 Receive Data +
		E6	PHY1 TX-	Ethernet connection 1 Transmission Data -
		E5	PHY1 TX+	Ethernet connection 1 Transmission Data +
		E4	PHY0 RX-	Ethernet connection 2 Receive Data -
		E3	PHY0 RX+	Ethernet connection 2 Receive Data +
		E2	PHY0 TX-	Ethernet connection 2 Transmission Data -
		E1	PHY0 TX+	Ethernet connection 2 Transmission Data +
2	System bus level and digital inputs	78	SYS -	System bus data line -
		77	SYS +	System bus data line +
		C1	DIN1	Digital input 1
		C2	DIN2	Digital input 2
		40	GND/0V	Reference potential (0 V/GND)
		44	24 V	Supply voltage (+24 V)
		40	GND/0V	Reference potential (0 V/GND)
		44	24 V	Supply voltage (+24 V)

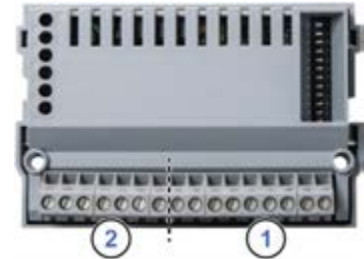

Schematic diagram - electrical connection

(Terminal designation for the example of NORD frequency inverter SK 180E...SK 2xxE)

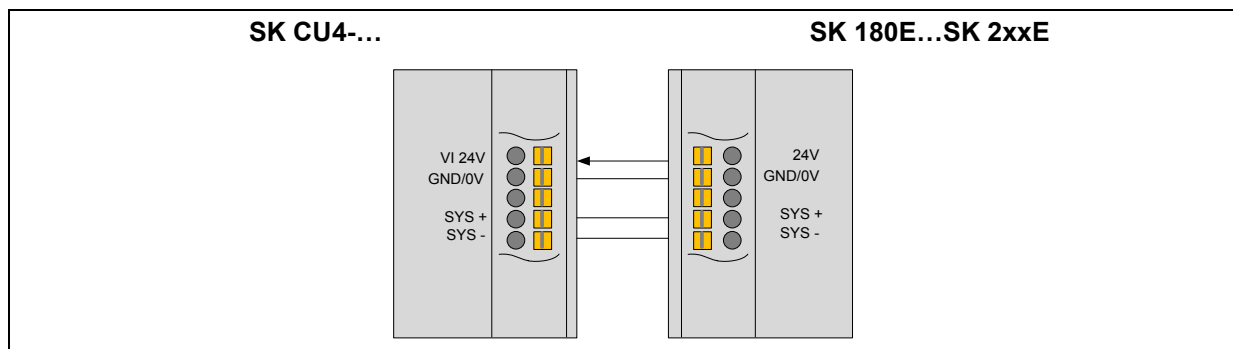

Configuration

No settings need to be made on the device. However, the bus interface can be configured with a fixed address because of the “Hot Connection Group” functionality, the so-called “Second Address”. This takes place using the DIP switches of the bus interface. The DIP switch settings are read after a “Power On” of the bus interface.

DIP switch											Meaning	
12	11	10	9	8	7	6	5	4	3	2	1	Address
X	X	0	0	0	0	0	0	0	0	0	X	0
X	X	0	0	0	0	0	0	0	0	1	X	1
X	X	0	0	0	0	0	0	0	1	0	X	2
X	X	-	-	-	-	-	-	-	-	-	X	-
X	X	1	1	1	1	1	1	1	1	1	X	511
											0	System bus terminating resistor not set.
											1	System bus terminating resistor set.
Access rights for remote maintenance												
											0	Only read access to parameters possible.
											1	Read and write access to parameters possible.
											0	No control possible.
											1	Control is possible.

1. System bus (DIP 1)

The system bus must be terminated at both physical ends.

2. Second Address (DIP 2...10)

The „Second Address“ can be set via this switch and controlled in parameter **P181**.

If all DIP switches 2...10 are moved to the “OFF” position, the „Second Address“ can be set via parameter **P160**.

3. Access rights for remote maintenance (DIP 11...12)

The bus interface and the connected frequency inverter can be accessed via remote maintenance using the TCP Ethernet protocol. The type of access is defined via the DIP switch with inputs 10 to 11.



LED indicators

The operating statuses of the bus interface are visualised using LED indicators.

No.	Name	Colour	Meaning
1	RUN	green	Ethernet State
	ERR	red	Ethernet Error
2	DS	green	Device State
	EN	red	Device error
3	L/A IN	green	Link/Activity IN
	L/A OUT	green	Link/Activity OUT

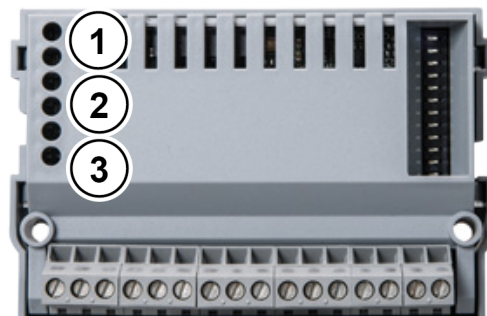

EtherCAT-specific LED

RUN	State	Meaning
OFF	Init	<ul style="list-style-type: none"> No communication of process data and parameters
Flashing	Pre-Operational	<ul style="list-style-type: none"> Parameter communication active No process data communication
Single Flash	Save Operational	<ul style="list-style-type: none"> Parameter communication active Restricted process data communication No restrictions to actual values Setpoints not evaluated
ON	Operational	<ul style="list-style-type: none"> Parameter communication active Unrestricted process data communication

ERR	State	Meaning
OFF	No Error	<ul style="list-style-type: none"> EtherCAT functioning normally on the bus interface
Flashing	Invalid Configuration	<ul style="list-style-type: none"> General EtherCAT configuration error, may be generated because of an erroneous XML file
Single Flash	Unsolicited State Change	<ul style="list-style-type: none"> Bus interface has changed the EtherCAT state without authorisation
Double Flash	Application Watchdog Timeout	<ul style="list-style-type: none"> EtherCAT or FI timeout (P513 or P151)

L/A (Green LED)	State	Meaning
OFF	No Connection	<ul style="list-style-type: none"> Bus interface not ready, no control voltage, No bus connection (check cable connection)
Flashing	Active	<ul style="list-style-type: none"> Bus interface connected and active
ON	Inactive	<ul style="list-style-type: none"> Bus interface ready for operation, but no bus activity present

NORD-specific LEDs

DS (Device State)	EN (Device Error)	Meaning
		long flashing = 0.5 s on / 1 s off short flashing = 0.25 s on / 1 s off
OFF	OFF	Bus interface not ready, no control voltage
ON	OFF	Bus interface ready, no error, at least one frequency inverter is communicating via the system bus
ON	Short flashing	Bus interface ready, but <ul style="list-style-type: none"> One or more of the connected frequency inverters has fault status
Long flashing	OFF	Bus interface ready and at least one other subscriber is connected to the system bus, but <ul style="list-style-type: none"> No frequency inverter on the system bus (or connection interrupted) One or more system bus subscriber has an address error Software incompatible (bus interface software and FI software incompatible - update required)
Long flashing	Short flashing Flash interval 1 x - 1s pause	System bus is in status "Bus Warning" <ul style="list-style-type: none"> Communication on system bus disrupted No other subscribers present on system bus Module not inserted correctly or no connection to system bus Frequency inverter has no supply voltage
Long flashing	Short flashing Flash interval 2 x - 1s pause	System bus is in status "Bus Off" <ul style="list-style-type: none"> The system bus 24 V power supply has been interrupted during operation
Long flashing	Short flashing Flash interval 3 x - 1s pause	System bus is in status "Bus Off" <ul style="list-style-type: none"> The 24V voltage supply of the system bus is missing
Long flashing	Short flashing Flash interval 4 x - 1s pause	Bus interface error <ul style="list-style-type: none"> See parameter P170
OFF	Short flashing Flash interval 1..7 - 1s pause	System error, internal program sequence interrupted <ul style="list-style-type: none"> EMC interference (observe the wiring guidelines!) Bus interface defective

Error messages

Error messages from the bus interface - current or archived message relating to the last fault - can be read out via bus interface parameter **P170**. The error messages are lost if the bus interface is switched off.

Error	Meaning	Remarks
100.0	EEPROM error	EMC faults, bus interface defective
102.0	Timeout	via P151/P513 monitoring
103.0	System bus BUS OFF	No 24 V supply to the bus, connections not correct
104.0	Bus interface temperature > 91 °C	only SK CU4-..., permissible internal temperature of the bus interface exceeded for approx. 60 sec
550.1	DIP switch error	The DIP switches (IP address) could not be read correctly
560.0 ... 560.9	Internal error	Bus interface not ready
561.0	General network error	
561.1	Ethernet Watchdog timeout	
561.2	Bus cable fault	Bus cable connection interrupted
561.3	IP address error	IP address of bus interface has been doubly assigned
563.0	Firmware version incompatible	The firmware version cannot be used for the device
564.0	MAC address defective	

Errors which occur in relation to the bus interface are depicted as follows in the error memory of the frequency inverter (P700 / P701).

Error (E010)	Meaning	Remarks
10.0	Connection error	Contact to SK xU4 lost
10.1	ASIC error	Communication with Ethernet ASIC lost <ul style="list-style-type: none"> Supply voltage shut-off Reduce temperature of bus interface to less than 91 °C (SK CU4-... only)
10.2	Ethernet Watchdog timeout	Telegram transfer error <ul style="list-style-type: none"> Check the connections and links, program sequence and Bus Master
10.3	Timeout by P151/P513	Telegram transfer error <ul style="list-style-type: none"> Check the connections and links Check the Watchdog time
10.4	IP address error	IP address of bus interface has been doubly assigned
10.5	Internal error	Module not ready for operation, configuration error
10.6	Bus cable fault	Bus cable connection interrupted
10.8	The connection between inverter and bus interface had timeout	SK TU3 bus interface only
10.9	Bus interface missing (P120)	SK xU4 bus interface only

Parameters

Frequency inverter: The following frequency inverter parameters must be adapted for setting up communication between the frequency inverter and the bus interface (for details please refer to the frequency inverter manual).



Parameter [-Array]	Meaning	Remarks
P120 [-01]	Option monitoring	"Auto" (default setting) Only SK xU4
P509	Source Control Word	SK TU3-... on SK 5xxE: "Ethernet TU" SK xU4-... on SK 180/SK 2xxE: "System bus"
P510 [-01]...[-02]	Setpoint source	"Auto" (default setting)
P513	Time-out	Monitoring of the SK TU3 bus interface Only SK 5xxE
P543 [-01]...[-03] ([-05]) and P543 ... P545	Bus actual value (1...3 (...5))	Possible settings according to P418
P546 [-01]...[-03] ([-05]) and P546 ... P548	Bus setpoint value (1...3 (...5))	Possible settings according to P400
P700 [-01]/ P701	Current/last faults	Information parameter
P740 / P741	Process data bus In / Out	Information parameter
P745	Module version	Information parameter Only SK TU3
P746	Module status	Information parameter Only SK TU3
P748	CANopen/System bus status	Information parameter

Bus interface: The bus interface provides a selection of appropriate parameters for setting or displaying special operating values. Parameters can be adapted using the NORDCON software or an SK PAR-3H / -3E parameter box. All parameters can still be read from and written to by the bus master via EtherCAT.

Parameter [-Array]	Meaning	Remarks	-TU3-	-TU4-	-CU4-
P150	Set relays	Set DOUT directly or control via bus		X	
P151	External bus time-out	Monitoring of SK xU4 bus interface		X	X
P152	Factory setting	Reset bus interface parameters	X	X	X
P153 [-01 ... -02]	Minimum system bus cycle	Reduction of bus load on the system bus caused by the bus interface (SK xU4 only)		X	X
P154 [-01 ... -02]	Access to option card I/O	Administration of read and write permissions to the IOs of the bus interface		X	X
P170 [-01 ... -02]	Present errors	Display bus interface errors	X	X	X
P171 [-01 ... -03]	Software version	Firmware version/Revision	X	X	X
P172	Configuration	Bus interface type	X	X	X
P173	Module status	Status of system bus or connected FC	X	X	X
P174	Status of digital inputs	Image of the switching status of DIN		X	X
P175	Digital output state	Image of the switching status of DOUT		X	
P176 [-01...]	Process data bus In	Information parameter	X	X	X
P177 [-01...]	Process data bus Out	Information parameter	X	X	X
P178	Internal temperature	Information parameter			X
P180	NMT State	Information parameter	X	X	X
P181	Second Address	Information parameter	X	X	X
P182	EtherCat Watchdog	Watchdog Supervision Time	X	X	X
P183 [-01...-04]	EtherCAT transfer error	Transmission error at EtherCAT level	X	X	X
P184	SPI error counter	Information parameter	X	X	X

Parameter access and diagnostics

The NORD CON software and optional control units such as the SK PAR-3H parameter box provide convenient access to the parameters of the bus interface and allow status information to be read out.

SK TU3-	SK TU4-	SK CU4- / SK TU4-
Access via RJ12 diagnostics socket of the SK 5xxE 	Access via RJ12 diagnostics socket of the bus connection unit SK TI4-TU-BUS(-C) 	Access via RJ12 frequency inverter diagnostics socket, if connected to the bus interface via the system bus. 

Further documentation and software (www.nord.com)

Software	Description
XML-file	Device characteristics and parameters

Software	Description
NORD CON	Parametrisation and diagnostic software

Document	Description
BU 0000	Description of NORD CON software
BU 0040	Parameter box manual
BU 0180	Frequency inverter manual SK 180E, SK 190E
BU 0200	Frequency inverter manual SK 2xxE

Document	Description
BU 2300	EtherCAT bus communication manual
TI 275274505	SK TIE4-M12-SYSS System bus connection expansion exit
TI 275274506	SK TIE4-M12-SYSS System bus connection expansion entrance
TI 275274514	SK TIE4-M12-SYSS Ethernet connection expansion entrance/exit