

## SK CU4-EIP-C

Part number: 275 271 519

### EtherNet/IP® – Internal Bus Interface

The bus interface may only be installed and commissioned by qualified electricians. An electrician is a person who, because of their technical training and experience, has sufficient knowledge with regard to

- Switching on, switching off, isolating, earthing and marking power circuits and devices,
- Proper maintenance and use of protective devices in accordance with defined safety standards.

### **DANGER**

### Danger of electric shock

The frequency inverter carries hazardous voltage for up to 5 minutes after being switched off.

- Work must not be carried out unless the frequency inverter has been disconnected from the voltage and at least 5 minutes has elapsed since the mains was switched off!

### **NOTICE**

### Validity of document

This document is only valid in conjunction with the operating instructions of the respective frequency inverter and the bus communication manual for this bus interface (📖 See overview at end of document). These documents contain all of the information that is required for safe commissioning of the bus interface module and the frequency inverter.

### Scope of delivery

|     |                      |                     |
|-----|----------------------|---------------------|
| 1 x | Bus interface        | SK CU4-EIP-C        |
| 1 x | System bus cable set | grey/black          |
| 1 x | 24 VDC cable set     | brown/blue          |
| 2 x | Connecting screws    | M4 x 20, cross-head |



### Usage area

Internal interface for the connection of a decentralised frequency inverter (SK 180E...SK 2xxE) to an **EtherNet/IP** field bus. This is connected to the inverter via the system bus, and can directly access up to 4 frequency inverters. 2 digital inputs are available. The module has a water-repellent coating. Reliable operation is retained even with condensation.

| Technical Information / Datasheet | SK CU4-EIP-C |       |      |    |
|-----------------------------------|--------------|-------|------|----|
| EtherNet/IP Bus module            | TI 275271519 | V 1.3 | 3517 | en |

## Technical Data

### Bus interface

|                   |                    |                      |   |
|-------------------|--------------------|----------------------|---|
| Temperature range | -25 °C ... xx °C * | Vibration resistance | 3M7   |
| Temperature class | Class 3K3          | Firmware version     | V1.3 R2   |
| Protection class  | IP20               | Supply voltage       | 24 V ± 20 %, ≈ 100 mA<br>Reverse polarity protected |

\* The upper temperature limit depends on the frequency inverter and the operating mode → see "Derating"

|                               |  |
|-------------------------------|--|
| Digital input - working range | Low: 0 V ... 5 V, High: 15 V ... 30 V  |
| Digital input - specific data | R <sub>i</sub> = 10 kΩ, input capacity: 10 nF, response time 1 ms, inputs as per EN 61131-2 type 1 |

### Bus specification

|                 |   |                   |                                      |
|-----------------|---|-------------------|--------------------------------------|
| Ethernet/IP     | max. 100 Mbaud                            | Cable             | Min. Ethernet CAT-5                  |
|                 | electrical isolation 500 V <sub>eff</sub> | Max. cable length | 100 m between two bus interfaces     |
| Bus connection  | Screw terminals                           | Shield            | Direct to PE                         |
| Bus termination | performed automatically                   | PE connection     | via PE screw cap in the terminal box |
| Status display  | 6 LEDs                                    |                   |                                      |
| Topology        | Star*, ring, linear bus                   |                   |                                      |

\* additional switch for "star" topology required

### Power

|   |          |
|---|----------|
| Update interval for process data between bus interface and frequency inverter | ≈ 2.5 ms |
| Parameter read access on the frequency inverter                               | ≈ 25 ms  |
| Parameter write access with storage in EEPROM                                 | ≈ 70 ms  |
| Cycle times   | ≥ 1 ms   |

## Derating

### NOTICE

### Derating

Depending on the installation location of the bus interface (SK 180E, SK 190E or SK 2xxE), the operating mode (S1, S3 ...) and the installation type (wall-mounting, motor-mounting) of the frequency inverter as well as the type of motor used (IE1 / IE2 / ...), restrictions to the permissible ambient temperature must be taken into account. If the permissible ambient temperature is exceeded, the bus interface can heat up to an impermissible extent and switch itself off with an error message (E104.0).

| Operating mode    | Installation type   | Maximum ambient temperature * |                |
|-------------------|---------------------|-------------------------------|----------------|
|                   |                     | SK 180E/SK 190E               | SK 2xxE        |
| S1                | Motor               | 25 °C                         | 30 °C          |
| S3 ED 50 %, 10min | Motor               | 40 °C                         | Not applicable |
| S3 ED 70 %, 10min | Motor               | Not applicable                | 40 °C          |
| S1                | Wall (unventilated) | 37 °C                         | 42 °C          |
| S1                | Wall (ventilated)   | 47 °C                         | 48 °C          |

\* The limits of the frequency inverter must not be exceeded (please refer to the frequency inverter manual).

**Bus interface characteristics**

|  |  |
|--|--|
| IO messages (process data connections) | 1 "Exclusive Owner"  |
|  | max. 2 "Listen Only" connections   |
|  | Type "Cyclic", min. cycle time 1 ms  |
| Explicit messages                      | Yes  |
| UCMM                                   | Supported  |
| DLR                                    | Supported  |
| Switch with two ports                  | integrated   |
| Addressing via                         | DIP switches, bus interface parameters, BOOTP and DHCP possible  |
| Access for NORD diagnostics tool via   | Diagnostic socket on the device (if available) or possibly via frequency inverter and the UDP or TCP/IP Ethernet protocols |

**Installation**

|                       |   |
|-----------------------|---|
| Installation location | Within the connection unit of a frequency inverter (SK 180E, SK 190E, 2xxE) |
| Fastening             | with screw fastenings   |

**Installation steps**

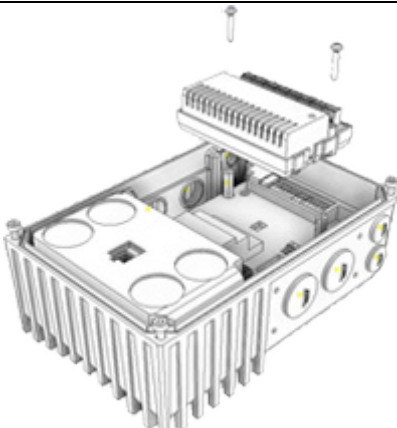
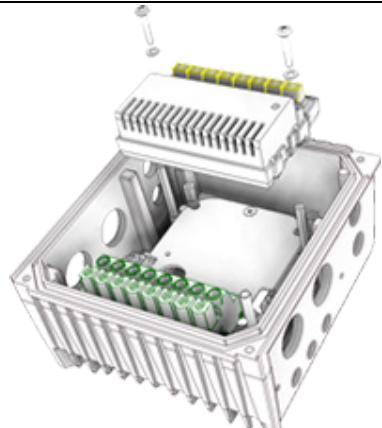
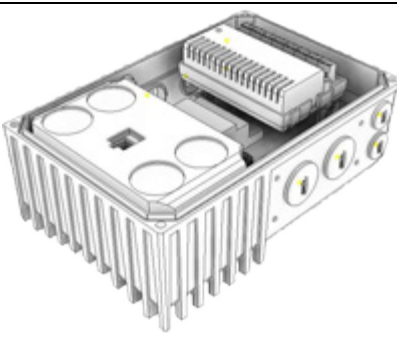
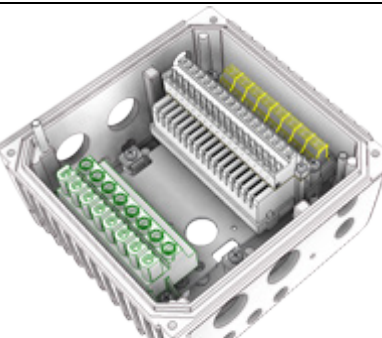
|    | SK 1xxE   | SK 2xxE  |
|----|---|--|
| 1. |  |  |
| 2. |  |  |

### Connections

Connection is via the terminal strip of the bus interface.

| Potential | Contact                             | Designation | Description |   |
|-----------|-------------------------------------|-------------|-------------|---|
| 1         | Ethernet                            | E8          | PHY1 RX-    | Ethernet connection 2 Receive Data -      |
|           |                                     | E7          | PHY1 RX+    | Ethernet connection 2 Receive Data +      |
|           |                                     | E6          | PHY1 TX-    | Ethernet connection 2 Transmission Data - |
|           |                                     | E5          | PHY1 TX+    | Ethernet connection 2 Transmission Data + |
|           |                                     | E4          | PHY0 RX-    | Ethernet connection 1 Receive Data -      |
|           |                                     | E3          | PHY0 RX+    | Ethernet connection 1 Receive Data +      |
|           |                                     | E2          | PHY0 TX-    | Ethernet connection 1 Transmission Data - |
|           |                                     | E1          | PHY0 TX+    | Ethernet connection 1 Transmission Data + |
| 2         | System bus level and digital inputs | 78          | SYS -       | System bus data line -                    |
|           |                                     | 77          | SYS +       | System bus data line +                    |
|           |                                     | C1          | DIN1        | Digital input 1                           |
|           |                                     | C2          | DIN2        | Digital input 2                           |
|           |                                     | 40          | GND/0V      | Reference potential (0 V/GND)             |
|           |                                     | 44          | 24 V        | Supply voltage (+24 V)                    |
|           |                                     | 40          | GND/0V      | Reference potential (0 V/GND)             |
|           |                                     | 44          | 24 V        | Supply voltage (+24 V)                    |

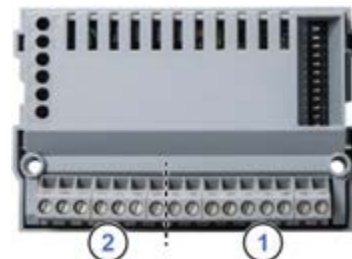

### Connection examples

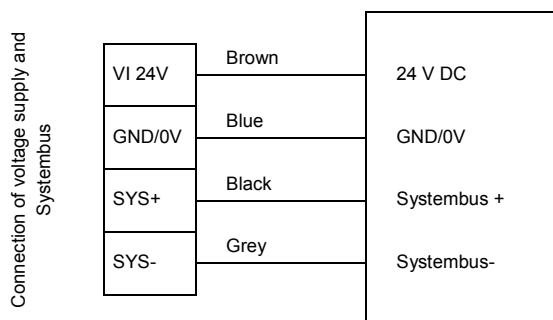

bus module

## Configuration

The basic configuration of the module is primarily carried out via its DIP switches. The DIP switch settings are read after a "Power On" of the bus interface.

| DIP switch                           |    |    |   |   |   |   |   |   |   |   | Meaning |   |
|--------------------------------------|----|----|---|---|---|---|---|---|---|---|---------|---|
| 12                                   | 11 | 10 | 9 | 8 | 7 | 6 | 5 | 4 | 3 | 2 | 1       | Address                                       |
| X                                    | X  | X  | 0 | 0 | 0 | 0 | 0 | 0 | 0 | 0 | X       | 0   |
| X                                    | X  | X  | 0 | 0 | 0 | 0 | 0 | 0 | 0 | 1 | X       | 1   |
| X                                    | X  | X  | 0 | 0 | 0 | 0 | 0 | 0 | 1 | 0 | X       | 2   |
| X                                    | X  | X  | 0 | - | - | - | - | - | - | - | X       | -   |
| X                                    | X  | X  | 1 | 1 | 1 | 1 | 1 | 1 | 1 | 1 | X       | 255   |
|                                      |    |    |   |   |   |   |   |   |   |   | 0       | System bus terminating resistor not set.      |
|                                      |    |    |   |   |   |   |   |   |   |   | 1       | System bus terminating resistor set.          |
| Access rights for remote maintenance |    |    |   |   |   |   |   |   |   |   |         |   |
|                                      |    | 0  |   |   |   |   |   |   |   |   |         | Only read access to parameters possible.      |
|                                      |    | 1  |   |   |   |   |   |   |   |   |         | Read and write access to parameters possible. |
|                                      |    | 0  |   |   |   |   |   |   |   |   |         | No control possible.                          |
|                                      |    | 1  |   |   |   |   |   |   |   |   |         | Control is possible.                          |
| 0                                    |    |    |   |   |   |   |   |   |   |   |         | TCP/IP open connection.                       |
| 1                                    |    |    |   |   |   |   |   |   |   |   |         | Secure TCP/IP connection.                     |

### 1. System bus (DIP 1)

The system bus must be terminated at both physical ends.

### 2. IP address (DIP 2 ... 9)

The final byte of the IP address can be set via this switch and is controlled in parameter **P185**. However, parameter **P165** must be set to the default setting (setting value "0").

### 3. Access rights for remote maintenance (DIP 10 ... 12)

The bus interface and the connected frequency inverter can be accessed using remote maintenance via the Ethernet TCP and UDP protocols. The type of access is defined via the DIP switch with inputs 10 to 12.



### LED indicators

The operating statuses of the bus interface are visualised using LED indicators.

| No. | Name  | Colour              | Meaning         |
|-----|-------|---------------------|-----------------|
| 1   | MS    | dual (red/green)    | Module State    |
|     | NS    | dual (red/green)    | Network State   |
| 2   | DS    | green               | Device State    |
|     | EN    | red                 | Device error    |
| 3   | L/A 1 | dual (green/yellow) | Link/Activity 1 |
|     | L/A 2 | dual (green/yellow) | Link/Activity 2 |

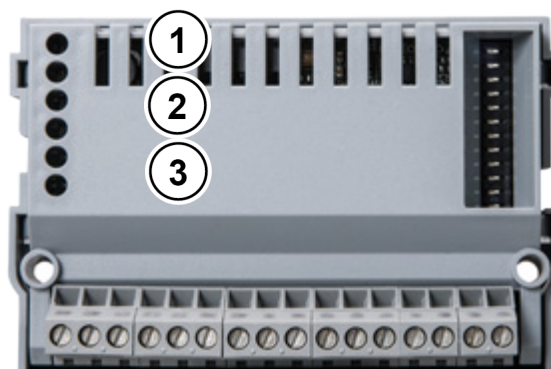

### EtherNet/IP-specific LEDs

| MS<br>(Module State)      | Meaning                           |
|---------------------------|-----------------------------------|
| <b>OFF</b>                | No operating voltage              |
| <b>Flashing green</b>     | Bus interface not configured      |
| <b>Green</b>              | Bus interface working correctly   |
| <b>Flashing red</b>       | Minor error, faulty configuration |
| <b>Red</b>                | Unrecoverable error               |
| <b>Flashing red/green</b> | Power up, self test               |

| NS<br>(Network State)     | Meaning   |
|---------------------------|---|
| <b>OFF</b>                | No operating voltage  |
| <b>Flashing green</b>     | IP address configured but no CIP connection available               |
| <b>Green</b>              | CIP connection(s) available   |
| <b>Flashing red</b>       | Time-out, an "exclusive owner connection" has a time-out error      |
| <b>Red</b>                | Dual IP whose IP address is already being used by the bus interface |
| <b>Flashing red/green</b> | Power up, self test   |

| Link<br>(Green LED) | Activity<br>(Yellow LED)   | Meaning  |
|---------------------|----------------------------|--|
| <b>OFF</b>          | <b>OFF</b>                 | <ul style="list-style-type: none"> <li>Bus interface not ready, no control voltage</li> <li>No bus connection (check cable connection)</li> </ul>      |
| <b>ON</b>           | <b>OFF</b>                 | <ul style="list-style-type: none"> <li>Bus connection (cable connection) to another Ethernet device exists</li> <li>No bus activity present</li> </ul> |
| <b>ON</b>           | <b>Flashing (Blinking)</b> | <ul style="list-style-type: none"> <li>Bus connection (cable connection) to another Ethernet device exists</li> <li>Bus activity present</li> </ul>    |

## NORD-specific LEDs

| DS<br>(Device State) | EN<br>(Device Error)                                 | Meaning<br>long flashing = 0.5 s on / 1 s off<br>short flashing = 0.25 s on / 1 s off  |
|----------------------|--|--|
| OFF                  | OFF  | Bus interface not ready, no control voltage  |
| ON                   | OFF  | Bus interface ready, no error, at least one frequency inverter is communicating via the system bus   |
| ON                   | Short flashing                                       | Bus interface ready, but <ul style="list-style-type: none"> <li>One or more of the connected frequency inverters has fault status</li> </ul>   |
| Long flashing        | OFF  | Bus interface ready and at least one other subscriber is connected to the system bus, but <ul style="list-style-type: none"> <li>No frequency inverter on the system bus (or connection interrupted)</li> <li>One or more system bus subscriber has an address error</li> <li>Software incompatible (bus interface software and FI software incompatible - update required)</li> </ul> |
| Long flashing        | Short flashing<br>Flash interval<br>1 x - 1s pause   | System bus is in status "Bus Warning" <ul style="list-style-type: none"> <li>Communication on system bus disrupted</li> <li>No other subscribers present on system bus</li> <li>Module not inserted correctly or no connection to system bus</li> <li>Frequency inverter has no supply voltage</li> </ul>  |
| Long flashing        | Short flashing<br>Flash interval<br>2 x - 1s pause   | System bus is in status "Bus Off" <ul style="list-style-type: none"> <li>The system bus 24 V power supply has been interrupted during operation</li> </ul>   |
| Long flashing        | Short flashing<br>Flash interval<br>3 x - 1s pause   | System bus is in status "Bus Off" <ul style="list-style-type: none"> <li>The 24V voltage supply of the system bus is missing</li> </ul>  |
| Long flashing        | Short flashing<br>Flash interval<br>4 x - 1s pause   | Bus interface error <ul style="list-style-type: none"> <li>See parameter <b>P170</b></li> </ul>  |
| OFF                  | Short flashing<br>Flash interval<br>1...7 - 1s pause | System error, internal program sequence interrupted <ul style="list-style-type: none"> <li>EMC interference (observe the wiring guidelines!)</li> <li>Bus interface defective</li> </ul>   |

## Error messages

Error messages from the bus interface - current or archived message relating to the last fault - can be read out via bus interface parameter **P170**. The error messages are lost if the bus interface is switched off.

| Error              | Meaning                       | Remarks  |
|--------------------|-------------------------------|--|
| 100.0              | EEPROM error                  | EMC faults, bus interface defective  |
| 102.0              | Timeout                       | via P151/P513 monitoring   |
| 103.0              | System bus BUS OFF            | No 24 V supply to the bus, connections not correct   |
| 104.0              | Module temperature > 97 °C    | SK CU4-... only, permissible internal temperature of bus interface exceeded for approx. 60 sec |
| 550.1              | DIP switch error              | The DIP switches (IP address) could not be read correctly                                      |
| 560.0 ...<br>560.9 | Internal error                | Bus interface not ready  |
| 561.0              | General network error         |  |
| 561.1              | Ethernet Watchdog timeout     |  |
| 561.2              | Bus cable fault               | Bus cable connection interrupted   |
| 561.3              | IP address error              | IP address of bus interface has been doubly assigned   |
| 563.0              | Firmware version incompatible | The firmware version cannot be used for the device   |
| 564.0              | MAC address error             |  |

Bus interface-related errors are depicted as follows in the error memory of the frequency inverter (**P700 / P701**).

| Error (E010) | Meaning   | Remarks  |
|--------------|---|--|
| 10.0         | Connection error  | Contact to SK xU4 lost   |
| 10.1         | ASIC error  | Communication to Ethernet - ASIC lost <ul style="list-style-type: none"> <li>• Supply voltage shut-off</li> <li>• for SK CU4-... e.g.: Temperature &gt; 97 °C</li> </ul> |
| 10.2         | Ethernet/IP Watchdog timeout                                  | Telegram transfer error <ul style="list-style-type: none"> <li>• Check the connections and links, program sequence and Bus Master</li> </ul>                             |
| 10.3         | Timeout by P151/P513  | Telegram transfer error <ul style="list-style-type: none"> <li>• Check the connections and links</li> <li>• Check the Watchdog time</li> </ul>                           |
| 10.4         | IP address error  | IP address of bus interface has been doubly assigned   |
| 10.5         | Internal error  | Bus interface not ready  |
| 10.6         | Bus cable fault   | Bus cable connection interrupted   |
| 10.8         | The connection between inverter and bus interface had timeout | SK TU3 bus interface only  |
| 10.9         | Bus interface missing (P120)                                  | SK xU4 bus interface only  |



## Parameters

**Frequency inverter:** The following frequency inverter parameters must be adapted for setting up communication between the frequency inverter and the bus interface (for details please refer to the frequency inverter manual).



| Parameter [-Array]                         | Meaning                           | Remarks  |              |
|--|-----------------------------------|--|--------------|
| P120 [-01]                                 | Option monitoring                 | "Auto" (default setting)   | Only SK xU4  |
| P509                                       | Source Control Word               | SK TU3-... on SK 5xxE: "Ethernet TU"<br>SK xU4-... on SK 180/SK 2xxE: "System bus" |              |
| P510 [-01]...[-02]                         | Setpoint source                   | "Auto" (default setting)   |              |
| P513                                       | Time-out                          | Monitoring of the SK TU3 bus interface   | Only SK 5xxE |
| P543 [-01]...[-03] ([-05]) and P543...P545 | Bus actual value (1...3 (...5))   | Possible settings according to P418  |              |
| P546 [-01]...[-03] ([-05]) and P546...P548 | Bus setpoint value (1...3 (...5)) | Possible settings according to P400  |              |
| P700 [-01]/P701                            | Current/last faults               | Information parameter  |              |
| P740/P741                                  | Process data bus In / Out         | Information parameter  |              |
| P745                                       | Module version                    | Information parameter  | Only SK TU3  |
| P746                                       | Module status                     | Information parameter  | Only SK TU3  |
| P748                                       | CANopen/System bus status         | Information parameter  |              |

**Bus interface:** The bus interface provides a selection of appropriate parameters for setting or displaying special operating values. Parameters can be adapted using the NORDCON software or an SK PAR-3H / -3E parameter box. All parameters can still be read and written by the bus master via EtherNet/IP.

| Parameter [-Array] | Meaning                      | Remarks  | -TU3- | -TU4- | -CU4- |
|--------------------|------------------------------|--|-------|-------|-------|
| P150               | Set relays                   | Set DOUT directly or control via BUS   |       | X     |       |
| P151               | External bus time-out        | Monitoring of SK xU4 bus interface   |       | X     | X     |
| P152               | Factory setting              | Reset bus interface parameters   | X     | X     | X     |
| P153 [-01 ...-02]  | Minimum system bus cycle     | Reduction of bus load on the system bus caused by the bus interface                            |       | X     | X     |
| P154 [-01 ...-02]  | Access to option card I/O    | Administration of read and write permissions to the IOs of the bus interface                   |       | X     | X     |
| P160 [-01...-04]   | IP address                   | Alternative to setting the array value [-04]: DIP switch, → Value from DIP-switch has priority | X     | X     | X     |
| P161 [-01...-04]   | IP subnet mask               |  | X     | X     | X     |
| P164 [-01...-04]   | IP Gateway                   |  | X     | X     | X     |
| P165               | Addressing mode              | Setting "0" = value from DIP-switch or P160 (default setting)                                  | X     | X     | X     |
| P166               | Process data transmit format | Leave at default setting   | X     | X     | X     |
| P169               | Password                     |  | X     | X     | X     |
| P170 [-01 ... -02] | Present errors               | Display bus interface errors   | X     | X     | X     |
| P171 [-01 ... -03] | Software version             | Firmware version / Revision  | X     | X     | X     |
| P172               | Configuration                | Bus interface type   | X     | X     | X     |
| P173               | Module status                | Status of system bus or the connected FI   | X     | X     | X     |
| P174               | Status of digital inputs     | Image of the switching status of DIN   |       | X     | X     |
| P175               | Digital output state         | Image of the switching status of DOUT  |       | X     |       |
| P176 [-01...]      | Process data bus In          | Information parameter  | X     | X     | X     |
| P177 [-01...]      | Process data bus Out         | Information parameter  | X     | X     | X     |
| P178               | Internal temperature         | Information parameter  |       |       | X     |
| P180 [-01 ... -02] | Active assembly              | Information parameter  | X     | X     | X     |
| P181 [-01 ... -06] | MAC address                  | Information parameter  | X     | X     | X     |
| P185 [-01 ...-04]  | Present IP address           | Information parameter  | X     | X     | X     |
| P186 [-01 ...-04]  | Current IP subnet mask       | Information parameter  | X     | X     | X     |

### Parameter access and diagnostics

The NORD CON software and optional control units such as the SK PAR-3H parameter box provide convenient access to the parameters of the bus interface and allow status information to be read out.

| SK TU3-  | SK TU4-   | SK CU4- / SK TU4-   |
|--|---|---|
| <p>Access via RJ12 diagnostics socket of the SK 5xxE</p>  | <p>Access via RJ12 diagnostics socket of the bus connection unit <b>SK TI4-TU-BUS(-C)</b></p>  | <p>Access via RJ12 frequency inverter diagnostics socket, if connected to the bus interface via the system bus.</p>  |

### Further documentation and software ([www.nord.com](http://www.nord.com))

| Software                   | Description                              |
|----------------------------|--|
| <a href="#">EDS - file</a> | Electronic Data Sheet (Object data file) |

| Software                 | Description                             |
|--------------------------|---|
| <a href="#">NORD CON</a> | Parametrisation and diagnostic software |

| Document                | Description                                |
|-------------------------|--|
| <a href="#">BU 0000</a> | Description of NORD CON software           |
| <a href="#">BU 0040</a> | Parameter box manual                       |
| <a href="#">BU 0180</a> | Frequency inverter manual SK 180E, SK 190E |
| <a href="#">BU 0200</a> | Frequency inverter manual SK 2xxE          |

| Document                     | Description  |
|------------------------------|--|
| <a href="#">BU 2100</a>      | Ethernet/IP bus communication manual                         |
| <a href="#">TI 275274505</a> | SK TIE4-M12-SYSM System bus connection expansion exit        |
| <a href="#">TI 275274506</a> | SK TIE4-M12-SYSS System bus connection expansion entrance    |
| <a href="#">TI 275274514</a> | SK TIE4-M12-SYSM Ethernet connection expansion entrance/exit |