

## SK TI4-TU-MSW-C

Part number: 275 280 700

Connection unit

### NOTICE

### Validity of this document

This document is only valid in combination with the operating instructions of the relevant frequency inverter and under strict compliance with the safety and warning instructions which they contain. Safe commissioning of this module and the frequency inverter depends on the availability of this information.

### Scope of delivery

1 x	Connection unit	SK TI4-TU-MSW-C
1 x	Gasket	2 mm, self-adhesive
2 x	Lead through grommet	22 mm x 9.5 mm
4 x	Hexagonal socket screw	M4 x 20



### Field of use

The connection unit forms the basis for the maintenance switch of type SK TU4-MSW-.... The connection unit can be mounted on, or in the immediate vicinity of an electronic control technology frequency inverter.

### Technical data

Temperature range	-25 °C ... 50 °C
Temperature class	Class 3K4
Protection class	IP66
Vibration resistance	3M7
Dimensions [mm]	H x W x D: 95 x 136 x 55

Current rating	16 A
Cable cross section	AWG 20-10
rigid	0.5 - 6 mm <sup>2</sup>
flexible	0.5 - 6 mm <sup>2</sup>
Nominal voltage	1~ 100 V – 240 V 3~ 200 V – 500 V

<b>Technical Information / Datasheet</b>	<b>SK TI4-TU-MSW-C</b>			
Connection unit	TI 275280700	V 1.1	5115	EN

### Features

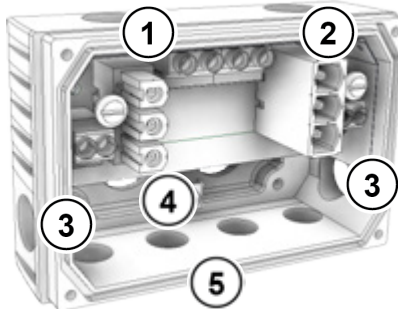
1.	No function, M20 x 1,5	
2.	No function, M20 x 1,5	
3.	Cable entry M20 x 1.5 (1 on left, 1 on right, option location 5L and 5R): e.g. For the connection of control and signal lines.	
4.	Cable entry M25 x 1.5 (2 pcs.): Leadthrough for wiring between optional assembly and device (frequency inverter) with direct attachment.	
5.	Cable entry M16x1.5 (4 pcs., option location 1 to 4): e.g. for the connection of control and signal lines.	

### Information

### M12 connector

NORD can supply prefabricated M12 connection expansions for manufacturing plug-in connections.

These can be screwed directly into the M16 cable lead-ins. The two existing side cable lead-ins (M20) can be used if a suitable reducer is used ([TI 275274511](#)).

### Installation

Installation location	To the left or right of the device. Alternatively: near by the device by using the wall mounting kit SK TIE4-WMK-TU ( <a href="#">TI 275274002</a> ).
Mounting	Using screw connection (4 x hexagon socket M4 x 20)

### ATTENTION

### Sealing

Ensure that no leaks are present during installation (assembly, cable leadthroughs, cable glands) in order to avoid penetration by moisture and therefore the risk of corrosion and short circuiting.

### Installation steps for attachment to the device



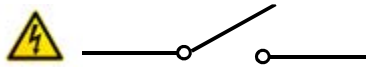
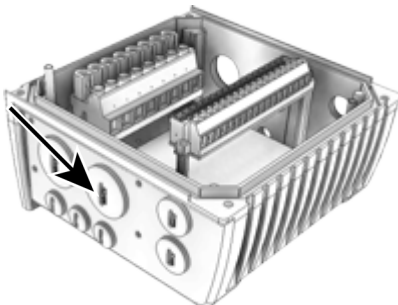

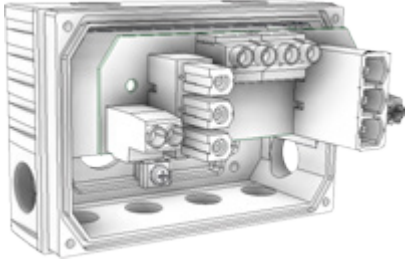
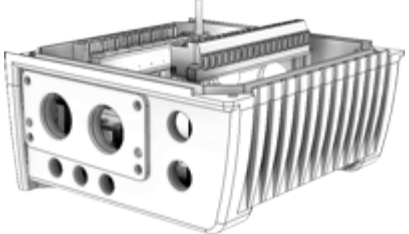
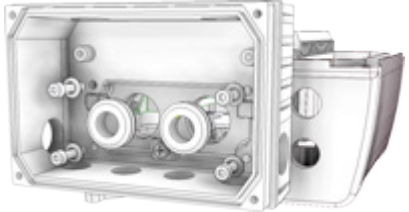
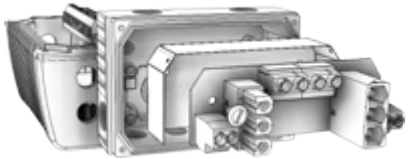
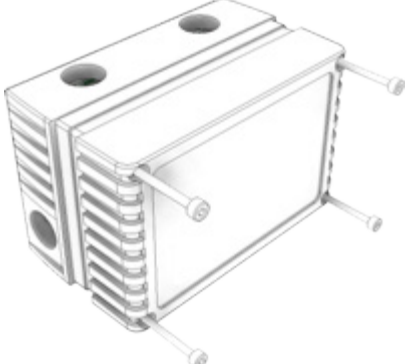
1.	Switch off the mains power.	
2.	Remove the two M25 blind caps from the relevant side of the frequency inverter (right / left).	

3.	Remove circuit board (with terminal strip) from connection unit SK TI4-TU-....	
4.	Fit provided seal to the device..	
5.	Fit SK TI4-TU-.... connection unit to device with the 4 provided screw bolts. Insert both of the provided leadthrough grommets into the M25 leadthroughs (to protect internal wiring between assembly and device).	
6.	Re-install circuit board (see point 3) and make the electrical connection.	
7.	Fit SK TU4- assembly and screw in place.	

**Wall mounting assembly steps**

*(Wall mounting kit SK TIE4-TU-WMK optionally available)*

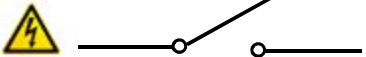

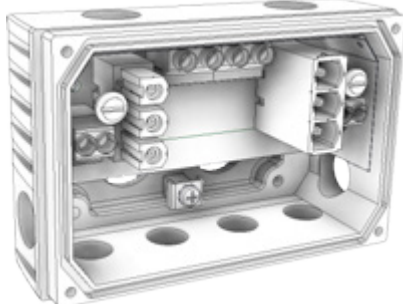
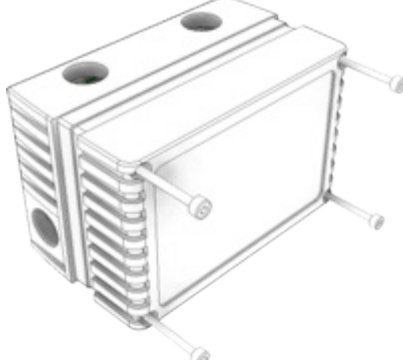
1.	Switch off the mains power.	
2.	Install provided seal to SK TI4-TU-.... connection unit.	
3.	Attach SK TI4-TU-.... connection unit to wall mounting kit. Screw the 2 cheese-head screws (wall mounting kit accessory pack) into the provided holes (countersunk) from the outside.	
4.	Insert the two screw bolts (wall mounting kit accessory pack) into the freely accessible holes in the rear panel from the inside and screw in place.	
5.	Install unit at usage location and make electrical connection ( <b> cable length max. 20 m</b> ).	
5.	Attach SK TU4- assembly and screw in place.	

**ATTENTION**

**IP66 addition**

To protect the assembly from condensation, the provided diaphragm valve must be screwed in. In order to do this, remove the uppermost M20 cable screw connection and screw in the reducer that is also included in the scope of delivery.

**Connections**

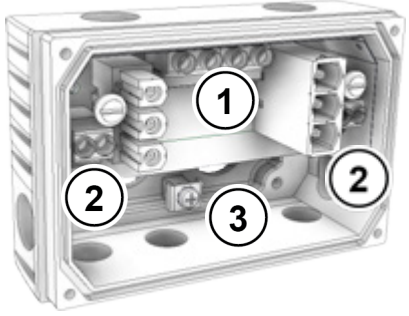
1	Supply (mains)	Screw terminal with 4 contacts L1, L2, L3, PE	Depending on mains: 1~ 100 - 240 V: L1/L2 3~ 200 - 500 V: L1/L2/L3	
2	Output (device)	Screw terminal with 2 x 2 contacts L1, L2 / L3, PE	Depending on mains: 1~ 100 - 240 V: L1/L2 3~ 200 - 500 V: L1/L2/L3/PE	
3	PE connection	via housing	If fitted to the device (e.g. frequency inverter): make connection to PE of device using the provided cable (green/yellow).	

Depending on the supply network, the electrical connections at the supply and output sides must be identical.

Mains	Phase		Contact
1-phase	L1	→	L1
	N	→	L2
3-phase	L1	→	L1
	L2	→	L2
	L3	→	L3
	PE	→	PE

**Additional documentation and software ([www.nord.com](http://www.nord.com))**

Document	Name	Document	Meaning
<a href="#">TI 275274002</a>	Wall mounting kit for SK TIE4-WMK-TU	<a href="#">Various</a>	Data sheets for M12 - connection expansions