

SK TU4-CAO-M12-C

Part number: 275 281 251

CANopen® – External Bus Interface

The bus interface may only be installed and commissioned by qualified electricians. An electrician is a person who, because of their technical training and experience, has sufficient knowledge with regard to

- Switching on, switching off, isolating, earthing and marking power circuits and devices,
- Proper maintenance and use of protective devices in accordance with defined safety standards.

DANGER

Danger of electric shock

The frequency inverter carries hazardous voltage for up to 5 minutes after being switched off.

- Work must not be carried out unless the frequency inverter has been disconnected from the voltage and at least 5 minutes has elapsed since the mains was switched off!

NOTICE

Validity of document

This document is only valid in conjunction with the operating instructions of the respective frequency inverter and the bus communication manual for this bus interface (📖 See overview at end of document). These documents contain all of the information that is required for safe commissioning of the bus interface module and the frequency inverter.

Scope of delivery

1 x	Bus interface	SK TU4-CAO-M12-C
4 x	Hexagonal socket screw	M4 x 40 mm
<i>Accessories required:</i>		
1 x	Bus connection unit TI 275280500	SK TI4-TU-BUS-C (Part No.: 275 280 500)



Usage area

External technology unit for connecting a decentralised frequency inverter (SK 180E...SK 2xxE) to a **CANopen** field bus. The bus interface can be mounted on, or in the immediate vicinity of the frequency inverter. This is connected to the inverter via the system bus, and can directly access up to 4 frequency inverters. 4 digital inputs and 2 digital outputs are available.

Technical Information / Datasheet		SK TU4-CAO-M12-C			
CANopen Bus module		TI 275281251	V 1.2	4217	en

Technical Data

Bus interface

Temperature range	-25 °C...50 °C
Temperature class	Class 3K4
Protection class	IP66
Supply voltage	24 V ± 20 %, ≈ 100 mA Reverse polarity protected

Vibration resistance	3M7
Firmware version	V2.2 R2
Hardware version	AA
Dimensions [mm]*	H x W x D: 95 x 136 x 99

* bus interface fitted to bus connection unit
Depth: 108 mm with cover caps on M12 connection

Digital input - working range	Low: 0 V ... 5 V, High: 15 V ... 30 V
Digital input - specific data	$R_i = 8 \text{ k}\Omega$, input capacity: 10 nF, response time 1 ms, inputs as per EN 61131-2 type 1
Digital output - 24 VDC power supply	≤ 400 mA (input)
Digital input - working range	Low = 0 V, High = 24 V; max. 200 mA

Bus specification

CANopen	Max. 1 MBit/s																												
	electrical isolation 500 V_{eff}																												
Bus connection	Connection terminals																												
Bus termination	via DIP switch on the bus interface																												
Status display	10 LEDs																												
Topology	Linear bus																												
Cable	twisted, shielded two-conductor cable																												
Cable length	depending on transmission speed:																												
	<table border="1"> <thead> <tr> <th>Bus cable length</th> <th>Resistance</th> <th>Cross-section</th> <th>Transfer rate</th> </tr> </thead> <tbody> <tr> <td>Up to 25 m</td> <td>70 mΩ/m</td> <td>≥ 0.25 mm², AWG23</td> <td>1 Mbit/s</td> </tr> <tr> <td>25...50 m</td> <td>70 mΩ/m</td> <td>≥ 0.25 mm², AWG23</td> <td>800 KBit/s</td> </tr> <tr> <td>50...80 m</td> <td>< 60 mΩ/m</td> <td>≥ 0.34 mm², AWG22</td> <td>500 KBit/s</td> </tr> <tr> <td>80...230 m</td> <td>< 40 mΩ/m</td> <td>≥ 0.5 mm², AWG21</td> <td>250 KBit/s</td> </tr> <tr> <td>230...480 m</td> <td>< 26 mΩ/m</td> <td>≥ 0.75 mm², AWG18</td> <td>125 KBit/s</td> </tr> <tr> <td>480...1000 m</td> <td>< 20 mΩ/m</td> <td>≥ 1 mm², AWG...</td> <td>50 KBit/s</td> </tr> </tbody> </table>	Bus cable length	Resistance	Cross-section	Transfer rate	Up to 25 m	70 m Ω /m	≥ 0.25 mm ² , AWG23	1 Mbit/s	25...50 m	70 m Ω /m	≥ 0.25 mm ² , AWG23	800 KBit/s	50...80 m	< 60 m Ω /m	≥ 0.34 mm ² , AWG22	500 KBit/s	80...230 m	< 40 m Ω /m	≥ 0.5 mm ² , AWG21	250 KBit/s	230...480 m	< 26 m Ω /m	≥ 0.75 mm ² , AWG18	125 KBit/s	480...1000 m	< 20 m Ω /m	≥ 1 mm ² , AWG...	50 KBit/s
	Bus cable length	Resistance	Cross-section	Transfer rate																									
	Up to 25 m	70 m Ω /m	≥ 0.25 mm ² , AWG23	1 Mbit/s																									
	25...50 m	70 m Ω /m	≥ 0.25 mm ² , AWG23	800 KBit/s																									
	50...80 m	< 60 m Ω /m	≥ 0.34 mm ² , AWG22	500 KBit/s																									
	80...230 m	< 40 m Ω /m	≥ 0.5 mm ² , AWG21	250 KBit/s																									
	230...480 m	< 26 m Ω /m	≥ 0.75 mm ² , AWG18	125 KBit/s																									
480...1000 m	< 20 m Ω /m	≥ 1 mm ² , AWG...	50 KBit/s																										
Shield	via metal cable lead-in to PE																												
PE connection	via PE screw cap in terminal box																												

Power

Update interval for process data between bus interface and frequency inverter	≤ 8 ms ^{1,2}
Parameter read/write access on the frequency inverter	> 20 ms ²

¹ depending on bus utilisation

² depending on the setting of the **P153 min. system bus cycle** parameter

Bus interface characteristics

Parametrisation	CANopen via SDO
Addressing	via DIP switch
Setting the baud rate	via DIP switch
Supported CANopen profile	Communication profile DS -301
	Drive profile DS -402
Error Messages (Emergency Messages)	to CANopen communication profile DS-301
Access for NORD diagnosis tool via	diagnostics socket on the device (if available) and via frequency inverter

Installation

The bus interface must be attached to a suitable connection unit (SK TI4-TU...) and connected using the 4 provided M4 x 40 mm hexagon socket collar screws. Installation details can be found in the data sheet for the relevant connection units.

Connections

The connection of the field bus lines, signal lines and control lines takes place via the bus connection unit **SK TI4-TU-BUS(-C)**.

Terminals	Double-sprung terminal bar	2 x 18 contacts
Cable cross section	AWG 14-26	rigid: 0,14 ... 2,5 mm flexible: 0.14 ... 1.5 mm with wire end sleeves
PE connection	Via housing	
RJ12	RJ45 - socket	Interface for connecting a parameterisation tool

Potential	Contact	Designation	Description
1	CANopen	1	24V-B CAO External 24 V supply CANopen field bus
		2	24V-B CAO External 24 V supply CANopen field bus
		3	CAO+ IN CANopen Data cable + (Receive)
		4	CAO+ OUT CANopen Data cable + (Transmit)
		5	CAO- IN CANopen Data cable - (Receive)
		6	CAO- OUT CANopen Data cable - (Transmit)
		7	GND B CAO Bus reference potential
		8	GND B CAO Bus reference potential
		9	SHLD Bus shield
		10	SHLD Bus shield
2	System bus level and digital inputs	11	24 V Supply voltage (+24 V)
		12	24 V Supply voltage (+24 V)
		13	24 V Supply voltage (+24 V)
		14	Sys + System bus data line +
		15	GND Reference potential (0 V/GND)
		16	Sys - System bus data line -
		17	GND Reference potential (0 V/GND)
		18	GND Reference potential (0 V/GND)
		19	DIN1 Digital input 1
		20	DIN3 Digital input 3
		21	GND Reference potential (0 V/GND)
		22	GND Reference potential (0 V/GND)
		23	24 V Supply voltage (+24 V)
		24	24 V Supply voltage (+24 V)
		25	DIN2 Digital input 2
		26	DIN4 Digital input 4
		27	GND Reference potential (0 V/GND)
		28	GND Reference potential (0 V/GND)
		29	24 V Supply voltage (+24 V)
		30	24 V Supply voltage (+24 V)
3	Digital outputs	31	24V o DO Supply voltage (+24 V)
		32	GND o DO Reference potential (0 V / GND) of the digital outputs
		33	DO 1 Digital output 1 (+24 V, 500 mA)
		34	DO 2 Digital output 2 (+24 V, 500 mA)
		35	GND o DO Reference potential (0 V / GND) of the digital outputs
		36	GND o DO Reference potential (0 V / GND) of the digital outputs
4	Diagnosis	RJ12 - 1	RS485_A Data cable RS485
		RJ12 - 2	RS485_B Data cable RS485
		RJ12 - 3	GND Reference potential (GND)
		RJ12 - 4	RS232_TxD Data cable RS232
		RJ12 - 5	RS232_RxD Data cable RS232
		RJ12 - 6	24 V Supply voltage (+24 V)



Connection examples

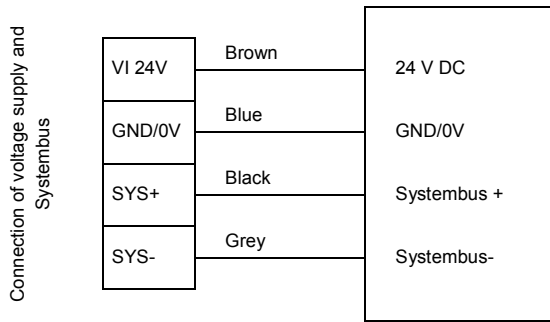

bus module

As an alternative to connecting to the bus connection unit, up to 4 sensors (digital inputs DI1...DI4) and up to 2 actuators (digital outputs DO1...DO2) can be connected via the M12 sockets at the front of the bus interface with normal commercial M12 system connectors. Contacts 19, 20, 25, 26, 33 and 34 of the bus connecting unit may not be used in this case.

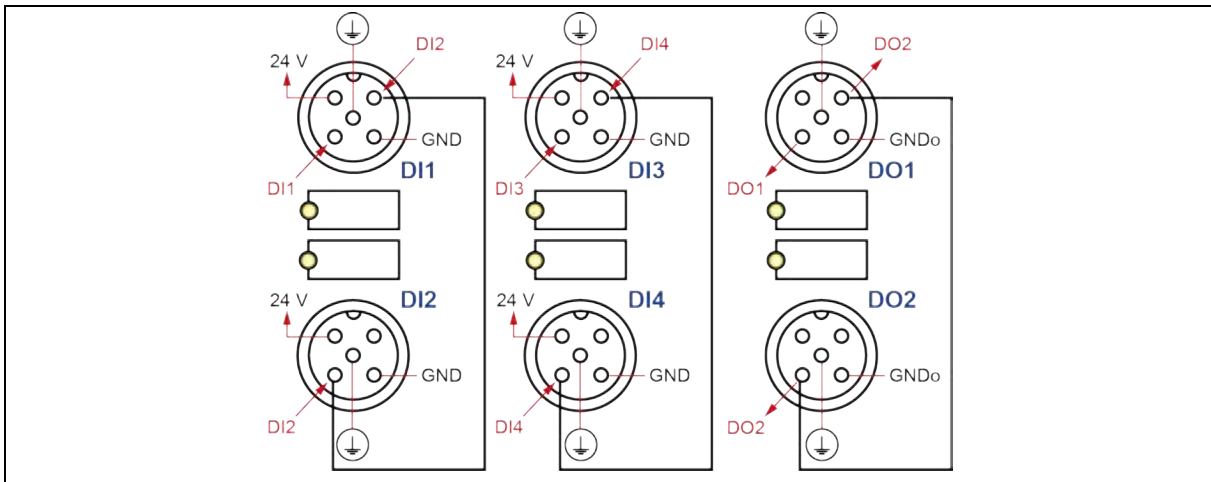

Configuration

The bus address (node ID), the bus interface (1) and the baud rate (2) are set via the DIP switches. The DIP switch setting results in the node identifier, which is read in after a “Power On” of the bus interface.

If the bus interface is the final subscriber on the CANopen field bus or the NORD system bus, the terminating resistor (3) must be activated.

DIP switch	Meaning	Department	Meaning
8	Identifier bit 5	Addressing	Bus address (Node ID) of bus interface
7	Identifier bit 4		
6	Identifier bit 3		
5	Identifier bit 2		
4	Identifier bit 1		
3	Identifier bit 0		
2	Baud rate bit 1	Baud rate	Bus interface baud rate
1	Baud rate bit 0		
3	—	Bus terminal	Not used
2	CAN Term.		Termination resistor for CANopen field bus
1	S-Bus Term.		Termination resistor for NORD system bus

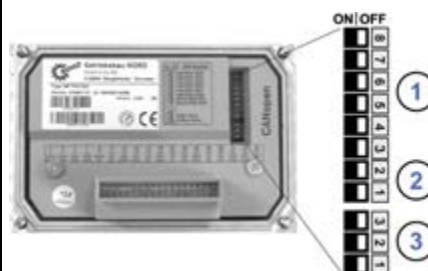

Factory settings DIP switches: **OFF**

1. Addressing (DIP 8 ... 3)

The setting of the node ID takes place with binary coding using DIP switches 8...3.

Address area "1"... "63".

2. Baud rate (DIP 2 ... 1)

The setting of the node ID takes place with binary coding using DIP switches 2...1.

DIP switch 2	DIP switch 1	Baud rate
OFF	OFF	125 kBaud
OFF	ON	250 kBaud
ON	OFF	500 kBaud
ON	ON	1 MBaud

3. Termination resistor (DIP 3... 1)

Set DIP switch 2 to the “ON” position if the bus interface is the final subscriber on the field bus. Set DIP switch 1 to the “ON” position if the bus interface is the final subscriber on the NORD system bus.

LED indicators

The operating statuses of the bus interface are visualised using LED indicators.

No.	Name	Colour	Meaning
1	EN	red	Device error
	DS	green	Device State
2	CE	red	CANopen Error
	CR	green	CANopen State

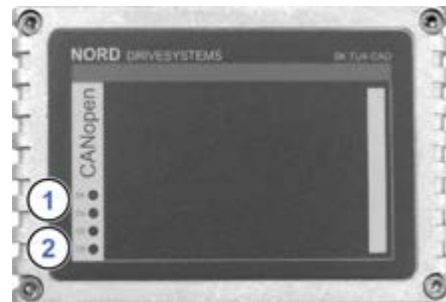

CANopen-specific LED

CR (CANopen State)	Meaning
OFF	No operating voltage, initialisation
Flashing green (1 s)	CANopen operating state "stopped"
Flashing green (0.5 s)	CANopen operating state "pre-operational"
Flashing green (0.25 s)	No other subscribers on the bus or wiring defective (only if the "CE" LED is flashing)
Green ON	CANopen operating state "operational"

CE (CANopen Error)	Meaning
OFF	No error
Flashing red	Bus warning, error counter of the CANopen controller has reached or exceeded the warning limit. → Check wiring / shielding / termination resistors.
	CANopen error → there is no physical connection to another subscriber
Red ON	CANopen controller disconnected from bus, since a serious error has occurred such as <ul style="list-style-type: none"> • Wiring error • Incorrect baud rate set

NORD-specific LEDs

DS (Device State)	EN (Device Error)	Meaning long flashing = 0.5 s on / 1 s off short flashing = 0.25 s on / 1 s off
OFF	OFF	Bus interface not ready, no control voltage
ON	OFF	Bus interface ready, no error, at least one frequency inverter is communicating via the system bus
ON	Short flashing	Bus interface ready, but <ul style="list-style-type: none"> One or more of the connected frequency inverters has fault status
Long flashing	OFF	Bus interface ready and at least one other subscriber is connected to the system bus, but <ul style="list-style-type: none"> No frequency inverter on the system bus (or connection interrupted) One or more system bus subscriber has an address error Software incompatible (bus interface software and FI software incompatible - update required)
Long flashing	Short flashing Flash interval 1 x - 1s pause	System bus is in status "Bus Warning" <ul style="list-style-type: none"> Communication on system bus disrupted No other subscribers present on system bus Module not inserted correctly or no connection to system bus Frequency inverter has no supply voltage
Long flashing	Short flashing Flash interval 2 x - 1s pause	System bus is in status "Bus Off" <ul style="list-style-type: none"> The system bus 24 V power supply has been interrupted during operation
Long flashing	Short flashing Flash interval 3 x - 1s pause	System bus is in status "Bus Off" <ul style="list-style-type: none"> The 24V voltage supply of the system bus is missing
Long flashing	Short flashing Flash interval 4 x - 1s pause	Bus interface error <ul style="list-style-type: none"> See parameter P170
OFF	Short flashing Flash interval 1...7 - 1s pause	System error, internal program sequence interrupted <ul style="list-style-type: none"> EMC interference (observe the wiring guidelines!) Bus interface defective

Digital input and output LEDs

LED (yellow)	Display	Meaning
DI1	ON	"High" potential present at terminal 19 or M12 socket "DI1".
	OFF	"Low" potential present at terminal 19 or M12 socket "DI1".
DI2	ON	"High" potential present at terminal 25 or M12 socket "DI2".
	OFF	"Low" potential present at terminal 25 or M12 socket "DI2".
DI3	ON	"High" potential present at terminal 20 or M12 socket "DI3".
	OFF	"Low" potential present at terminal 20 or M12 socket "DI3".
DI4	ON	"High" potential present at terminal 26 or M12 socket "DI4".
	OFF	"Low" potential present at terminal 26 or M12 socket "DI4".
DO1	ON	"High" potential output at terminal 33 or M12 socket "DO1".
	OFF	"Low" potential output at terminal 33 or M12 socket "DO1".
DO2	ON	"High" potential output at terminal 34 or M12 socket "DO2".
	OFF	"Low" potential output at terminal 34 or M12 socket "DO2".



Error messages

Error messages from the bus interface - current or archived message relating to the last fault - can be read out via module parameter **P170**. The error messages are lost if the bus interface is switched off.

Error	Meaning	Remarks
100.0	EEPROM error	EMC faults, bus interface defective
101.0	System bus 24 V missing	No 24 V voltage on bus, connections not correct
102.0	Bus timeout P151	By means of timeout supervision parameter P151/P513
103.0	System bus BUS OFF	No 24 V supply to the bus, connections not correct
511.0	CANopen BUS OFF	Bus subscriber not connected to bus
511.1	CANopen warning	Bus error
511.2	CANopen overrun	Message buffer of bus interface overwritten with new telegram before processing
511.3	Invalid CANopen address	Incorrect/duplicated bus address
512.0	CANopen timeout	Telegram transfer error

Bus interface-related errors are depicted as follows in the error memory of the frequency inverter (**P700 / P701**).

Error (E010)	Meaning	Remarks
10.2	External bus interface telegram timeout	Telegram transfer error <ul style="list-style-type: none"> Check the connections and links, program sequence and Bus Master.
10.3	Timeout by P151/P513	System bus supervision has triggered. <ul style="list-style-type: none"> Check time setting of parameter P151/P513. The release bit is missing in the control word.
10.4	External bus interface initialisation error	Unable to address bus interface. <ul style="list-style-type: none"> Check power supply of bus interface.
10.8	External bus interface communication error	SK TU3-CAO bus interface only: Connection between bus interface and frequency inverter interrupted.
10.9	Bus interface missing (P120)	Only bus interfaces SK CU4-CAO and SK TU4-CAO: Connection between bus interface and frequency inverter interrupted (see setting of parameter P120).

Parameters

Frequency inverter: The following frequency inverter parameters must be adapted for setting up communication between the frequency inverter and the bus interface (for details please refer to the frequency inverter manual).



Parameter [-Array]	Meaning	Remarks	
P120 [-01]	Option monitoring	"Auto" (default setting)	Only SK xU4
P509	Source Control Word	SK TU3-... on SK 5xxE: "Ethernet TU" SK xU4-... on SK 180/SK 2xxE: "System bus"	
P510 [-01]...[-02]	Setpoint source	"Auto" (default setting)	
P513	Time-out	Monitoring of the SK TU3 bus interface	Only SK 5xxE
P543 [-01]...[-03] ([-05]) and P543...P545	Bus actual value (1...3 (...5))	Possible settings according to P418	
P546 [-01]...[-03] ([-05]) and P546...P548	Bus setpoint value (1...3 (...5))	Possible settings according to P400	
P700 [-01]/P701	Current/last faults	Information parameter	
P740/P741	Process data bus In / Out	Information parameter	
P745	Module version	Information parameter	Only SK TU3
P746	Module status	Information parameter	Only SK TU3
P748	CANopen/System bus status	Information parameter	

Bus interface: The bus interface provides a selection of appropriate parameters for setting or displaying special operating values. Parameters can be adapted using the NORDCON software or an SK PAR-3H / -3E parameter box. All parameters can still be read and written by the bus master via CANopen.

Parameter [-Array]	Meaning	Remarks
P150	Set relays	Set DOUT directly or control via BUS
P151	External bus time-out	Monitoring of SK xU4 bus interface
P152	Factory setting	Reset bus interface parameters
P153 [-01]...[-02]	Minimum system bus cycle	Reduction of bus load on the system bus caused by the bus interface
P154 [-01]...[-02]	Access to option card I/O	Administration of read and write rights to the IO of the module
P160 [-01]...[-10]	COB-ID On/Off	Assignment of process data and service data objects
P161 [-01]...[-19]	COB-ID	Assignment of COB-ID for process data and service data objects
P162 [-01]...[-10]	PDO transmission type	Confirm transmission type for process data objects
P163 [-01]...[-05]	TxPDO Inhibit time	Confirm transmission break for process data objects
P164 [-01]...[-05]	TxPDO Event time	Confirm delay time for process data transfer
P165 [-01]...[-34]	PDO Mapping Para	Specify PDO objects
P166 [-01]...[-02]	Timeout Control	Set supervision interval
P167	Life time factor	Set supervision factor
P168 [-01]...[-17]	Drive profile	Set profile parameters (velocity mode)
P170 [-01]...[-02]	Present errors	Display bus interface errors
P171 [-01]...[-03]	Software version	Firmware version/Revision
P172	Configuration	Bus interface type
P173	Module status	Status of system bus or the connected FI
P174	Status of digital inputs	Image of the switching status of DIN
P175	Digital output state	Image of the switching status of DOUT
P176 [-01]...[-17]	Process data bus In	Information parameter
P177 [-01]...[-17]	Process data bus Out	Information parameter
P180	CANopen address	Information parameter
P181	CANopen baud rate	Information parameter

Parameter access and diagnostics

The NORD CON software and optional control units such as the SK PAR-3H parameter box provide convenient access to the parameters of the bus interface and allow status information to be read out.

SK TU3-	SK TU4-	SK CU4- / SK TU4-
Access via RJ12 diagnostics socket of the SK 5xxE 	Access via RJ12 diagnostics socket of the bus connection unit SK TI4-TU-BUS(-C) 	Access via RJ12 frequency inverter diagnostics socket, if connected to the bus interface via the system bus. 

Further documentation and software (www.nord.com)

Software	Description
EDS-file	Device characteristics and parameters

Software	Description
NORD.CON	Parametrisation and diagnostic software

Document	Description
BU_0000	Description of NORD CON software
BU_0040	Parameter box manual
BU_0180	Frequency inverter manual SK 180E, SK 190E
BU_0200	Frequency inverter manual SK 2xxE
BU_2500	Description of CANopen bus communication

Document	Description
TI_275280500	Bus connection unit SK TI4-TU-BUS-C
TI_275274505	SK TIE4-M12-SYSS System bus connection expansion exit
TI_275274506	SK TIE4-M12-SYSS System bus connection expansion entrance
TI_275274515	SK TIE4-M12-CAO-OUT CANopen connection expansion output
TI_275274501	SK TIE4-M12-CAO CANopen connection expansion entrance