

GETRIEBEBAU NORD

Member of the NORD DRIVESYSTEMS Group

Getriebebau NORD GmbH & Co. KG

Getriebebau-Nord-Straße 1 • 22941 Bargteheide, Germany • www.nord.com



SK CU4-EIP

Part number: 275 271 019

EtherNet/IP® – Internal Bus Interface

The bus interface may only be installed and commissioned by qualified electricians. An electrician is a person who, because of their technical training and experience, has sufficient knowledge with regard to

- Switching on, switching off, isolating, earthing and marking power circuits and devices,
- Proper maintenance and use of protective devices in accordance with defined safety standards.

 **DANGER**

Danger of electric shock

The frequency inverter carries hazardous voltage for up to 5 minutes after being switched off.

- Work must not be carried out unless the frequency inverter has been disconnected from the voltage and at least 5 minutes has elapsed since the mains was switched off.

Validity of document

This document is only valid in conjunction with the operating instructions of the respective frequency inverter and the bus communication manual for this bus interface ( See overview at end of document). These documents contain all of the information that is required for safe commissioning of the bus interface module and the frequency inverter.

Scope of delivery

1 x	Bus interface	SK CU4-EIP
1 x	System bus cable set	grey / black
1 x	24 VDC cable set	brown / blue
2 x	Connecting screws	M4 x 20, cross-head



Usage area

Internal interface for the connection of a decentralised frequency inverter (NORDAC *BASE*, NORDAC *FLEX*, NORDAC *LINK*) to an **EtherNet/IP** field bus. This is connected to the inverter via the system bus, and can directly access up to 4 frequency inverters. 2 digital inputs are available.

Technical Information / Datasheet	SK CU4-EIP			
EtherNet/IP Bus module	TI 275271019	V 1.7	0623	en

Technical Data

Bus interface

Temperature range	-25 °C ... xx °C *	Vibration resistance	3M7
Temperature class	Class 3K3	Protection class	IP20
		Supply voltage	24 V ± 20 %, ≈ 100 mA Reverse polarity protected

* The upper temperature limit depends on the frequency inverter and the operating mode → see "Derating"

Digital input - working range	Low: 0 V ... 5 V, High: 15 V ... 30 V
Digital input - specific data	R _i = 10 kΩ, input capacity: 10 nF, response time 1 ms, inputs as per EN 61131-2 type 1

Bus specification

Ethernet/IP	max. 100 Mbaud	Cable	Min. Ethernet CAT-5
	electrical isolation 500 V _{eff}	Max. cable length	100 m between two bus interfaces
Bus connection	Screw terminals	Shield	Direct to PE
Bus termination	performed automatically	PE connection	via PE screw cap in the terminal box
Status display	6 LEDs		
Topology	Star*, ring, linear bus		

* additional switch for "star" topology required

Power

Update interval for process data between bus interface and frequency inverter	≥ 5 ms
Parameter read access on the frequency inverter	≈ 15 ms
Parameter write access with storage in EEPROM	≈ 25 ms
Cycle times	≥ 1 ms

Derating

Depending on the installation location of the bus interface (NORDAC *BASE* or NORDAC *FLEX*), the operating mode (S1, S3 ...) and the installation type of the frequency inverter (wall-mounting, motor-mounting) as well as the type of motor used, restrictions to the permissible ambient temperature must be taken into account. If the permissible ambient temperature is exceeded, the bus interface can heat up to an impermissible extent and switch itself off with an error message (E104.0).

Operating mode	Installation type	Maximum ambient temperature *	
		NORDAC <i>BASE</i>	NORDAC <i>FLEX</i>
S1	Motor	25 °C	30 °C
S3 ED 50 %, 10 min	Motor	40 °C	Not applicable
S3 ED 70 %, 10 min	Motor	Not applicable	40 °C
S1	Wall (unventilated)	37 °C	42 °C
S1	Wall (ventilated)	47 °C	48 °C

* The limits of the frequency inverter must not be exceeded (please refer to the frequency inverter manual).

Bus interface characteristics

IO messages (process data connections)	1 "Exclusive Owner"
	max. 2 "Listen Only" connections
	Type "Cyclic", min. cycle time 1 ms
Explicit messages	Yes
UCMM	Supported
DLR	Supported
Switch with two ports	integrated
Addressing via	DIP switches, bus interface parameters, BOOTP and DHCP possible
Access for NORD diagnostics tool via	Diagnostic socket on the device (if available) or possibly via frequency inverter and the UDP or TCP/IP Ethernet protocols

Installation

Installation location	In defined option slot inside the NORDAC device.
Fastening	with screw fastenings

- 1) With NORDAC *LINK*, this assembly must be selected when ordering. The installation is then carried out at the factory. Subsequent installation is not possible.

Installation steps

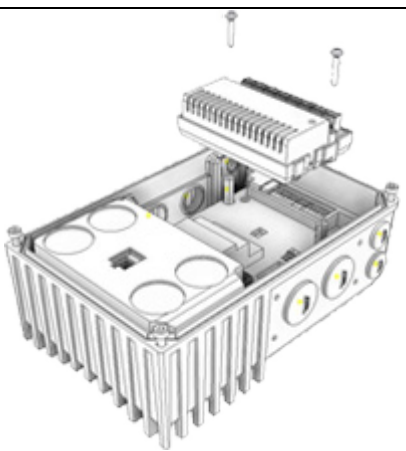
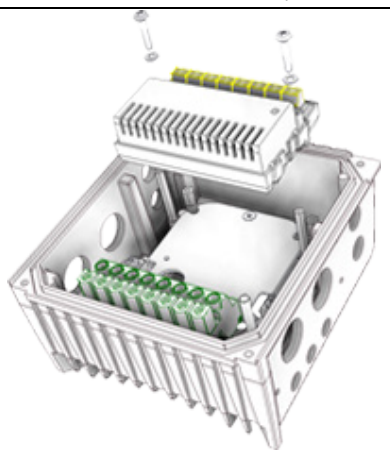
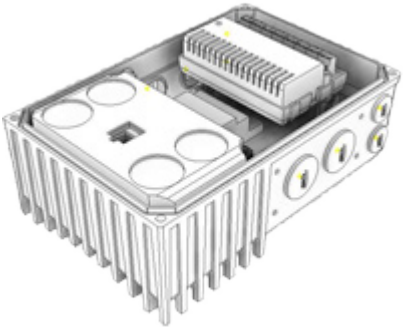
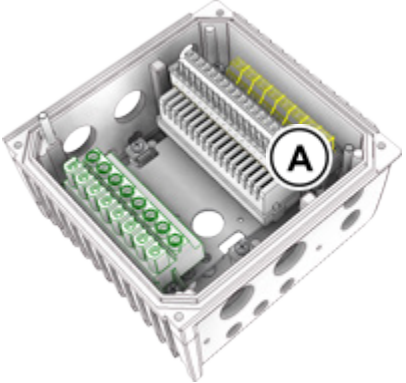
	NORDAC <i>BASE</i>	NORDAC <i>FLEX</i> *)
1.		
2.		

- *) Before carrying out installation step 1 it may be necessary to remove the control terminal bar (A),
The control terminal bar (A) must be fitted after installation step 2.

Connections

Connection is via the terminal strip of the bus interface.

Potential	Contact	Designation	Description	
1	Ethernet	E8	PHY1 RX-	Ethernet connection 2 Receive Data -
		E7	PHY1 RX+	Ethernet connection 2 Receive Data +
		E6	PHY1 TX-	Ethernet connection 2 Transmission Data -
		E5	PHY1 TX+	Ethernet connection 2 Transmission Data +
		E4	PHY0 RX-	Ethernet connection 1 Receive Data -
		E3	PHY0 RX+	Ethernet connection 1 Receive Data +
		E2	PHY0 TX-	Ethernet connection 1 Transmission Data -
		E1	PHY0 TX+	Ethernet connection 1 Transmission Data +
2	System bus level and digital inputs	78	SYS -	System bus data line -
		77	SYS +	System bus data line +
		C1	DIN1	Digital input 1
		C2	DIN2	Digital input 2
		40	GND/0V	Reference potential (0 V/GND)
		44	24 V	Supply voltage (+24 V)
		40	GND/0V	Reference potential (0 V/GND)
		44	24 V	Supply voltage (+24 V)

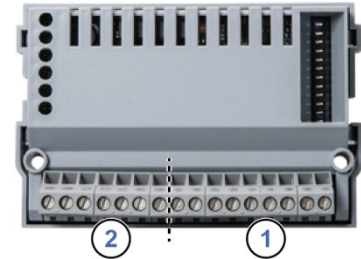

Connection examples

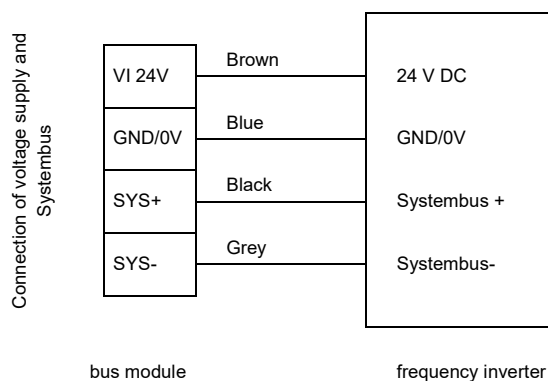

Configuration

The basic configuration of the module is primarily carried out via its DIP switches. The DIP switch settings are read after a "Power On" of the bus interface.

DIP switch											Meaning	
12	11	10	9	8	7	6	5	4	3	2	1	Address
X	X	X	0	0	0	0	0	0	0	0	X	0
X	X	X	0	0	0	0	0	0	0	1	X	1
X	X	X	0	0	0	0	0	0	1	0	X	2
X	X	X	0	-	-	-	-	-	-	-	X	-
X	X	X	1	1	1	1	1	1	1	1	X	255
											0	System bus terminating resistor not set.
											1	System bus terminating resistor set.
Access rights for remote maintenance												
		0										Only read access to parameters possible.
		1										Read and write access to parameters possible.
		0										No control possible.
		1										Control is possible.
0												TCP/IP open connection.
1												Secure TCP/IP connection.

1. System bus (DIP 1)

The system bus must be terminated at both physical ends.

2. IP address (DIP 2 ... 9)

The final byte of the IP address can be set via this switch and is controlled in parameter **P185**. However, parameter **P165** must be set to the default setting (setting value "0").

3. Access rights for remote maintenance (DIP 10 ... 12)

The bus interface and the connected frequency inverter can be accessed using remote maintenance via the Ethernet TCP and UDP protocols. The type of access is defined via the DIP switch with inputs 10 to 12.



Factory settings DIP switches: **OFF**

Information

NORDAC LINK

With the NORDAC LINK, the DIPP switch settings can only be adjusted at the factory. Subsequent adaptation is not possible. The configuration of the module must therefore be defined when ordering.

LED indicators

The operating statuses of the bus interface are visualised using LED indicators.

No.	Name	Colour	Meaning
1	MS	dual (red/green)	Module State
	NS	dual (red/green)	Network State
2	DS	green	Device State
	EN	red	Device error
3	L/A 1	dual (green/yellow)	Link/Activity 1
	L/A 2	dual (green/yellow)	Link/Activity 2

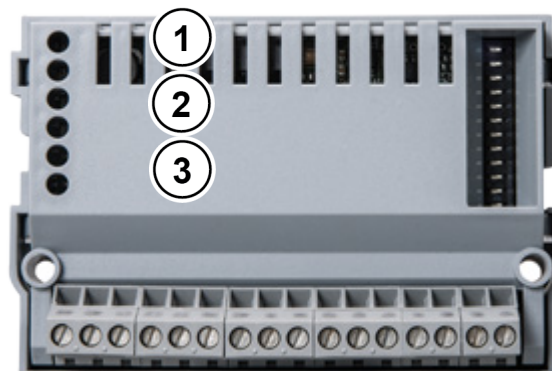

EtherNet/IP-specific LEDs

MS (Module State)	Meaning
OFF	No operating voltage
Flashing green	Bus interface not configured
Green	Bus interface working correctly
Flashing red	Minor error, faulty configuration
Red	Unrecoverable error
Flashing red/green	Power up, self test

NS (Network State)	Meaning
OFF	No operating voltage
Flashing green	IP address configured but no CIP connection available
Green	CIP connection(s) available
Flashing red	Time-out, an "exclusive owner connection" has a time-out error
Red	Dual IP whose IP address is already being used by the bus interface
Flashing red/green	Power up, self test

Link (Green LED)	Activity (Yellow LED)	Meaning
OFF	OFF	<ul style="list-style-type: none"> • Bus interface not ready, no control voltage • No bus connection (check cable connection)
ON	OFF	<ul style="list-style-type: none"> • Bus connection (cable connection) to another Ethernet device exists • No bus activity present
ON	Flashing (Blinking)	<ul style="list-style-type: none"> • Bus connection (cable connection) to another Ethernet device exists • Bus activity present

NORD-specific LEDs

DS (Device State)	EN (Device Error)	Meaning long flashing = 0.5 s on / 1 s off short flashing = 0.25 s on / 1 s off
OFF	OFF	Bus interface not ready, no control voltage
ON	OFF	Bus interface ready, no error, at least one frequency inverter is communicating via the system bus
ON	Short flashing	Bus interface ready, but <ul style="list-style-type: none"> • One or more of the connected frequency inverters has fault status
Long flashing	OFF	Bus interface ready and at least one other subscriber is connected to the system bus, but <ul style="list-style-type: none"> • No frequency inverter on the system bus (or connection interrupted) • One or more system bus subscriber has an address error • Software incompatible (bus interface software and FI software incompatible - update required)
Long flashing	Short flashing Flash interval 1 x - 1s pause	System bus is in status "Bus Warning" <ul style="list-style-type: none"> • Communication on system bus disrupted • No other subscribers present on system bus • Module not inserted correctly or no connection to system bus • Frequency inverter has no supply voltage
Long flashing	Short flashing Flash interval 2 x - 1s pause	System bus is in status "Bus Off" <ul style="list-style-type: none"> • The system bus 24 V power supply has been interrupted during operation
Long flashing	Short flashing Flash interval 3 x - 1s pause	System bus is in status "Bus Off" <ul style="list-style-type: none"> • The 24V voltage supply of the system bus is missing
Long flashing	Short flashing Flash interval 4 x - 1s pause	Bus interface error <ul style="list-style-type: none"> • See parameter P170
OFF	Short flashing Flash interval 1...7 - 1s pause	System error, internal program sequence interrupted <ul style="list-style-type: none"> • EMC interference (observe the wiring guidelines!) • Bus interface defective

Parameter access and diagnosis

The NORDCON software or optional control units such as the SK PAR-3H ParameterBox provide convenient access to the parameters of the bus interface and allow status information to be read out. In addition, the NORDCON *APP* – in connection with the NORDAC *ACCESS BT* Bluetooth stick – offers a practical way of mobile and wireless maintenance as well as commissioning of NORD frequency inverters.

Access is via the RJ12 diagnostics socket of the frequency inverter. The prerequisite for this is that the bus interface is connected to the frequency inverter via the system bus.

Further documentation and software (www.nord.com)

Software	Description
EDS - file	Electronic Data Sheet (Object data file)

Software	Description
NORDCON	Parametrisation and diagnostic software

Document	Description
BU 0000	Description of NORDCON software
BU 0040	Parameter box manual
BU 0180	Frequency inverter manual NORDAC <i>BASE</i>
BU 0200	Frequency inverter manual NORDAC <i>FLEX</i>
BU 0250	Frequency inverter manual NORDAC <i>LINK</i>

Document	Description
TI 275274514	SK TIE4-M12-ETH Ethernet connection expansion entrance/exit
TI 275274505	SK TIE4-M12-SYSS System bus connection expansion exit
TI 275274506	SK TIE4-M12-SYSS System bus connection expansion entrance
BU 2100	EtherNet/IP bus communication manual