

GETRIEBEBAU NORD

Member of the NORD DRIVESYSTEMS Group



Getriebebau NORD GmbH & Co. KG

Getriebebau-Nord-Straße 1 • 22941 Bargteheide, Germany • www.nord.com

SK CU4-CAO-C

Part number: 275 271 501

CANopen® – Internal Bus Interface

The bus interface may only be installed and commissioned by qualified electricians. An electrician is a person who, because of their technical training and experience, has sufficient knowledge with regard to

- Switching on, switching off, isolating, earthing and marking power circuits and devices,
- Proper maintenance and use of protective devices in accordance with defined safety standards.



Danger of electric shock

The frequency inverter carries hazardous voltage for up to 5 minutes after being switched off.

- Work must not be carried out unless the frequency inverter has been disconnected from the voltage and at least 5 minutes has elapsed since the mains was switched off.

Validity of document

This document is only valid in conjunction with the operating instructions of the respective frequency inverter and the bus communication manual for this bus interface (📖 See overview at end of document). These documents contain all of the information that is required for safe commissioning of the bus interface module and the frequency inverter.

Scope of delivery

1 x	Bus interface	SK CU4-CAO-C
1 x	System bus cable set	grey/black
1 x	24 VDC cable set	brown/blue
2 x	Connecting screws	M4 x 20, cross-head

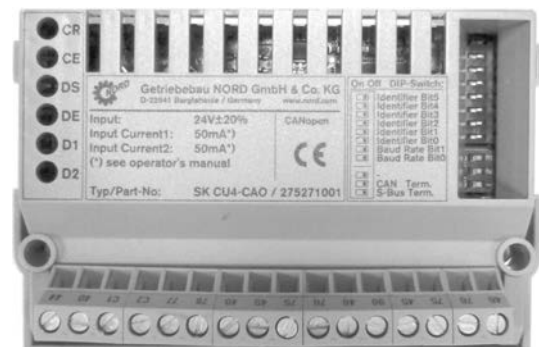

Usage area

Internal interface for connecting a decentralised frequency inverter (NORDAC *BASE*, NORDAC *FLEX*, NORDAC *LINK*) to a **CANopen** field bus. This is connected to the inverter via the system bus, and can directly access up to 4 frequency inverters. 2 digital inputs are available. The bus interface has a water-repellent coating. Reliable operation is retained even with condensation.

Technical Information / Datasheet		SK CU4-CAO-C			
CANopen Bus module		TI 275271501	V 1.3	0623	en

Technical Data

Bus interface

Temperature range	-25 °C...50 °C	Vibration resistance	3M7
Temperature class	Class 3K3	Protection class	IP20
		Supply voltage	24 V ± 20 %, ≈ 100 mA Reverse polarity protected

Digital input - working range	Low: 0 V ... 5 V, High: 11 V ... 30 V
Digital input - specific data	R _i = 8.1 kΩ, input capacity: 10 nF, response time 1 ms, inputs as per EN 61131-2 type 1

Bus specification

CANopen	Max. 1 MBit/s																												
	electrical isolation 500 V _{eff}																												
Bus connection	Screw terminals																												
Bus termination	via DIP switch on the bus interface																												
Status display	6 LEDs																												
Topology	Linear bus																												
Cable	twisted, shielded two-conductor cable																												
Cable length	depending on transmission speed:																												
	<table border="1"> <thead> <tr> <th>Bus cable length</th> <th>Resistance</th> <th>Cross-section</th> <th>Transfer rate</th> </tr> </thead> <tbody> <tr> <td>Up to 25 m</td> <td>70 mΩ/m</td> <td>≥ 0.25 mm², AWG23</td> <td>1 Mbit/s</td> </tr> <tr> <td>25...50 m</td> <td>70 mΩ/m</td> <td>≥ 0.25 mm², AWG23</td> <td>800 KBit/s</td> </tr> <tr> <td>50...80 m</td> <td>< 60 mΩ/m</td> <td>≥ 0.34 mm², AWG22</td> <td>500 KBit/s</td> </tr> <tr> <td>80...230 m</td> <td>< 40 mΩ/m</td> <td>≥ 0.5 mm², AWG21</td> <td>250 KBit/s</td> </tr> <tr> <td>230...480 m</td> <td>< 26 mΩ/m</td> <td>≥ 0.75 mm², AWG18</td> <td>125 KBit/s</td> </tr> <tr> <td>480...1000 m</td> <td>< 20 mΩ/m</td> <td>≥ 1 mm², AWG...</td> <td>50 KBit/s</td> </tr> </tbody> </table>	Bus cable length	Resistance	Cross-section	Transfer rate	Up to 25 m	70 mΩ/m	≥ 0.25 mm ² , AWG23	1 Mbit/s	25...50 m	70 mΩ/m	≥ 0.25 mm ² , AWG23	800 KBit/s	50...80 m	< 60 mΩ/m	≥ 0.34 mm ² , AWG22	500 KBit/s	80...230 m	< 40 mΩ/m	≥ 0.5 mm ² , AWG21	250 KBit/s	230...480 m	< 26 mΩ/m	≥ 0.75 mm ² , AWG18	125 KBit/s	480...1000 m	< 20 mΩ/m	≥ 1 mm ² , AWG...	50 KBit/s
	Bus cable length	Resistance	Cross-section	Transfer rate																									
	Up to 25 m	70 mΩ/m	≥ 0.25 mm ² , AWG23	1 Mbit/s																									
	25...50 m	70 mΩ/m	≥ 0.25 mm ² , AWG23	800 KBit/s																									
	50...80 m	< 60 mΩ/m	≥ 0.34 mm ² , AWG22	500 KBit/s																									
	80...230 m	< 40 mΩ/m	≥ 0.5 mm ² , AWG21	250 KBit/s																									
	230...480 m	< 26 mΩ/m	≥ 0.75 mm ² , AWG18	125 KBit/s																									
480...1000 m	< 20 mΩ/m	≥ 1 mm ² , AWG...	50 KBit/s																										
Shield	Direct to PE																												
PE connection	via PE screw cap in terminal box																												

Power

Update interval for process data between bus interface and frequency inverter	≥ 5 ms ^{1,2}
Parameter read/write access on the frequency inverter	> 20 ms ²

¹ depending on bus utilisation

² depending on the setting of the **P153 min. system bus cycle** parameter

Bus interface characteristics

Parametrisation	CANopen via SDO
Addressing	via DIP switch
Setting the baud rate	via DIP switch
Supported CANopen profile	Communication profile DS -301
	Drive profile DS -402
Error Messages (Emergency Messages)	to CANopen communication profile DS-301
Access for NORD diagnosis tool via	diagnostics socket on the device (if available) and via frequency inverter

Installation

Installation location	In defined option slot inside the NORDAC device.
Fastening	with screw fastenings

- 1) With NORDAC *LINK*, this assembly must be selected when ordering. The installation is then carried out at the factory. Subsequent installation is not possible.

Installation steps

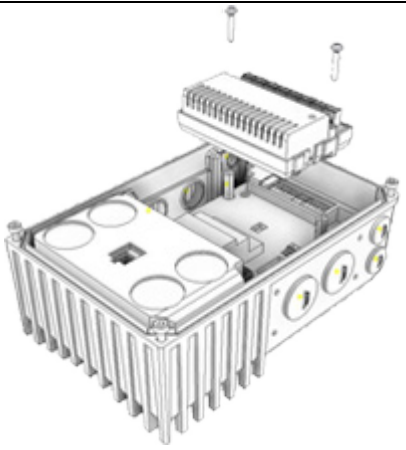
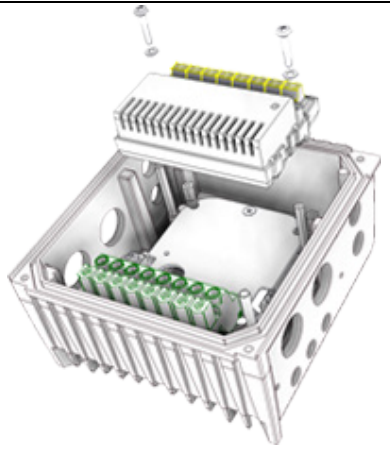
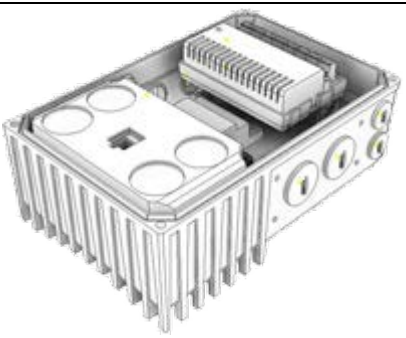
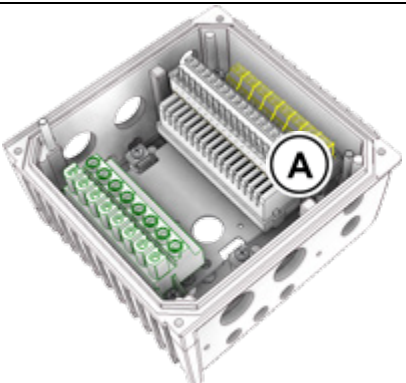
	NORDAC BASE	NORDAC FLEX *)
1.		
2.		

*) Before carrying out installation step 1 it may be necessary to remove the control terminal bar (A), The control terminal bar (A) must be fitted after installation step 2.

Connections

Connection is via the terminal strip of the bus interface.

Potential	Contact	Designation	Description	
1	System bus level and digital inputs	44	24 V	Supply potential (+24 V ±20%, 50 mA)
		40	GND	Reference potential (0 V/GND)
		C1	DIN1	Digital input 1
		C2	DIN2	Digital input 2
		77	Sys +	System bus data line +
		78	Sys -	System bus data line -
		40	GND	Reference potential (0 V/GND)
		2	CANopen	45
75	CANopen+			CANopen connection 1 Receive Data + (CAN H)
76	CANopen			CANopen connection 1 Receive Data - (CAN L)
46	GND Bus			Bus reference potential
90	SHLD			Bus shield
45	24 V Bus			Supply potential (+24 V ±20%, 50 mA)
75	CANopen+			CANopen connection 2 Transmit Data +
76	CANopen			CANopen connection 2 Transmit Data -
46	GND Bus	Bus reference potential		

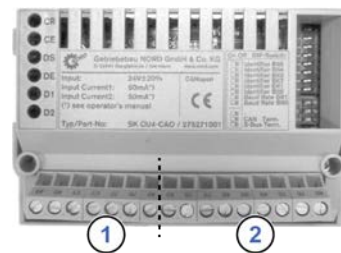

Connection examples

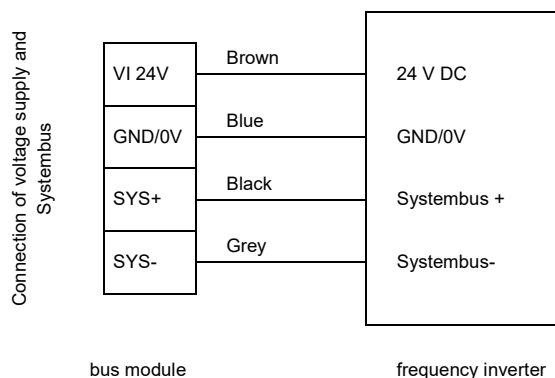

Configuration

The bus address (node ID), the bus interface (1) and the baud rate (2) are set via the DIP switches. The DIP switch setting results in the node identifier, which is read after a “Power On” of the bus interface.

If the bus interface is the final subscriber on the CANopen field bus or the NORD system bus, the terminating resistor (3) must be activated.

DIP switch	Meaning	Department	Meaning
8	Identifier bit 5	Addressing	Bus address (Node ID) of bus interface
7	Identifier bit 4		
6	Identifier bit 3		
5	Identifier bit 2		
4	Identifier bit 1		
3	Identifier bit 0		
2	Baud rate bit 1	Baud rate	Bus interface baud rate
1	Baud rate bit 0		
3	—	Bus terminal	Not used
2	CANopen		Termination resistor for CANopen field bus
1	System bus		Termination resistor for NORD system bus

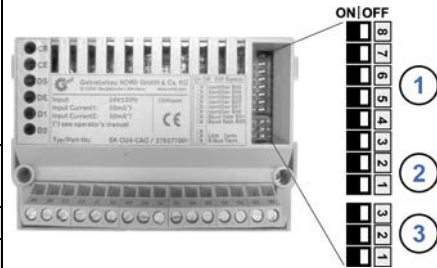

Factory settings DIP switches: **OFF**

1. Addressing (DIP 8 ... 3)

The setting of the node ID takes place with binary coding using DIP switches 8...3. Address area "1"..."63".

2. Baud rate (DIP 2 ... 1)

The setting of the node ID takes place with binary coding using DIP switches 2...1.

DIP switch 2	DIP switch 1	Baud rate
OFF	OFF	125 kBaud
OFF	ON	250 kBaud
ON	OFF	500 kBaud
ON	ON	1 MBaud

3. Termination resistor (DIP 3... 1)

Set DIP switch 2 to the “ON” position if the bus interface is the final subscriber on the field bus. Set DIP switch 1 to the “ON” position if the bus interface is the final subscriber on the NORD system bus.

Information

NORDAC LINK

With the NORDAC LINK, the DIPP switch settings can only be adjusted at the factory. Subsequent adaptation is not possible. The configuration of the module must therefore be defined when ordering.

LED indicators

The operating statuses of the bus interface are visualised using LED indicators.

No.	Name	Colour	Meaning
1	CR	green	CANopen State
	CE	red	CANopen Error
2	DS	green	Device State
	EN	red	Device error
3	D1	green	Digital input D1
	D2	green	Digital input D2

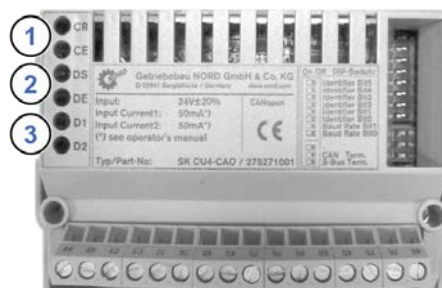

CANopen-specific LED

CR (CANopen State)	Meaning
OFF	No operating voltage, initialisation
Flashing green (1 s)	CANopen operating state "stopped"
Flashing green (0.5 s)	CANopen operating state "pre-operational"
Flashing green (0.25 s)	No other subscribers on the bus or wiring defective (only if the "CE" LED is flashing)
Green ON	CANopen operating state "operational"

CE (CANopen Error)	Meaning
OFF	No error
Flashing red	Bus warning, error counter of the CANopen controller has reached or exceeded the warning limit. → Check wiring / shielding / termination resistors. CANopen error → there is no physical connection to another subscriber
Red ON	CANopen controller disconnected from bus, since a serious error has occurred such as <ul style="list-style-type: none"> • Wiring error • Incorrect baud rate set

NORD-specific LEDs

DS (Device State)	DE (Device Error)	Meaning
		long flashing = 0.5 s on / 1 s off short flashing = 0.25 s on / 1 s off
OFF	OFF	Bus interface not ready, no control voltage
ON	OFF	Bus interface ready, no error, at least one frequency inverter is communicating via the system bus
ON	Short flashing	Bus interface ready, but <ul style="list-style-type: none"> • One or more of the connected frequency inverters has fault status
Long flashing	OFF	Bus interface ready and at least one other subscriber is connected to the system bus, but <ul style="list-style-type: none"> • No frequency inverter on the system bus (or connection interrupted) • One or more system bus subscriber has an address error • Software incompatible (bus interface software and FI software incompatible - update required)
Long flashing	Short flashing Flash interval 1 x - 1s pause	System bus is in status "Bus Warning" <ul style="list-style-type: none"> • Communication on system bus disrupted • No other subscribers present on system bus • Module not inserted correctly or no connection to system bus • Frequency inverter has no supply voltage
Long flashing	Short flashing Flash interval 2 x - 1s pause	System bus is in status "Bus Off" <ul style="list-style-type: none"> • The system bus 24 V power supply has been interrupted during operation
Long flashing	Short flashing Flash interval 3 x - 1s pause	System bus is in status "Bus Off" <ul style="list-style-type: none"> • The 24V voltage supply of the system bus is missing
Long flashing	Short flashing Flash interval 4 x - 1s pause	Bus interface error <ul style="list-style-type: none"> • See parameter P170
OFF	Short flashing Flash interval 1...7 - 1s pause	System error, internal program sequence interrupted <ul style="list-style-type: none"> • EMC interference (observe the wiring guidelines!) • Bus interface defective

Digital input LEDs

LED (green)	Display		Meaning
D1	ON		"High" potential present at terminal "C1".
		OFF	"Low" potential present at terminal "C1".
D2	ON		"High" potential present at terminal "C2".
		OFF	"Low" potential present at terminal "C2".

Parameter access and diagnosis

The NORDCON software or optional control units such as the SK PAR-3H ParameterBox provide convenient access to the parameters of the bus interface and allow status information to be read out. In addition, the NORDCON *APP* – in connection with the NORDAC *ACCESS BT* Bluetooth stick – offers a practical way of mobile and wireless maintenance as well as commissioning of NORD frequency inverters.

Access is via the RJ12 diagnostics socket of the frequency inverter. The prerequisite for this is that the bus interface is connected to the frequency inverter via the system bus.

Further documentation and software (www.nord.com)

Software	Description
EDS-file	Electronic Data Sheet (Object data file)

Software	Description
NORDCON	Parametrisation and diagnostic software

Document	Description
BU 0000	Description of NORDCON software
BU 0040	Parameter box manual
BU 0180	Frequency inverter manual NORDAC <i>BASE</i>
BU 0200	Frequency inverter manual NORDAC <i>FLEX</i>
BU 0250	Frequency inverter manual NORDAC <i>LINK</i>

Document	Description
BU 2500	CANopen bus communication manual
TI 275274505	SK TIE4-M12-SYSM System bus connection expansion exit
TI 275274506	SK TIE4-M12-SYSS System bus connection expansion entrance
TI 275274515	SK TIE4-M12-CAO-OUT CANopen connection expansion output
TI 275274501	SK TIE4-M12-CAO CANopen connection expansion entrance