

SK TU4-EIP

Part number: 275 281 119

EtherNet/IP® – External Bus Interface

The bus interface may only be installed and commissioned by qualified electricians. An electrician is a person who, because of their technical training and experience, has sufficient knowledge with regard to

- Switching on, switching off, isolating, earthing and marking power circuits and devices,
- Proper maintenance and use of protective devices in accordance with defined safety standards.

DANGER

Danger of electric shock

The frequency inverter carries hazardous voltage for up to 5 minutes after being switched off.

- Work must not be carried out unless the frequency inverter has been disconnected from the voltage and at least 5 minutes has elapsed since the mains was switched off.

Validity of document

This document is only valid in conjunction with the operating instructions of the respective frequency inverter and the bus communication manual for this bus interface ( See overview at end of document). These documents contain all of the information that is required for safe commissioning of the bus interface module and the frequency inverter.

Scope of delivery

1 x	Bus interface	SK TU4-EIP
4 x	Hexagonal socket screw	M4 x 40 mm
Accessories required:		
1 x	Bus connection unit TI 275280000	SK TI4-TU-BUS (Part No.: 275 280 000)



Usage area

External technology unit for connecting a distributed frequency inverter (SK 180E...SK 2xxE) to an **EtherNet/IP** field bus. The bus interface can be mounted on, or in the immediate vicinity of the frequency inverter. This is connected to the inverter via the system bus, and can directly access up to 4 frequency inverters. 8 digital inputs and 2 digital outputs are available.

Technical Information / Datasheet	SK TU4-EIP			
EtherNet/IP Bus module	TI 275281119	V 1.5	3621	en

Technical Data

Bus interface

Temperature range	-25 °C...50 °C
Temperature class	Class 3K3
Protection class	IP55
Supply voltage	24 V ± 20 %, ≈ 100 mA Reverse polarity protected

Vibration resistance	3M7
Firmware version	V1.4 R0
Hardware version	AA
Dimensions [mm]*	H x W x D: 95 x 136 x 99

*bus interface fitted to bus connection unit
Depth: 108 mm with cover caps on M12 connection

Digital input - working range	Low: 0 V ... 5 V, High: 15 V ... 30 V
Digital input - specific data	$R_i = 8 \text{ k}\Omega$, input capacity: 10 nF, response time 1 ms, inputs as per EN 61131-2 type 1
Digital output - 24 VDC power supply	≤ 400 mA (input)
Digital output - working range	Low = 0 V, High = 24 V; max. 200 mA

Bus specification

Ethernet/IP	max. 100 MBaud
	electrical isolation 500 V _{eff}
Bus connection	2 x M12
Bus termination	performed automatically
Status display	8 LEDs
Topology	Star*, ring, linear bus

Cable	Min. Ethernet CAT-5
Max. cable length	100 m between two bus interfaces
Shield	via M12 direct to PE
PE connection	via PE screw cap in the terminal box

* additional switch for "star" topology required

Power

Update interval for process data between bus interface and frequency inverter	≤ 5 ms
Parameter read access on the frequency inverter	≈ 15 ms
Parameter write access with storage in EEPROM	≈ 25 ms
Cycle times	≥ 1 ms

Bus interface characteristics

IO messages (process data connections)	1 "Exclusive Owner"
	max. 2 "Listen Only" connections
	Type "Cyclic", min. cycle time 1 ms
Explicit messages	Yes
UCMM	Supported
DLR	Supported
Switch with two ports	integrated
Addressing via	DIP switches, bus interface parameters, BOOTP and DHCP possible
Access for NORD diagnostics tool via	Diagnostic socket on the device (if available) or possibly via frequency inverter and the UDP or TCP/IP Ethernet protocols

Installation

The bus interface must be attached to a suitable connection unit (SK TI4-TU...) and connected using the 4 provided M4 x 40 mm hexagon socket collar screws. Installation details can be found in the data sheet for the relevant connection units.

Connections

The two Ethernet lines are connected exclusively via the two M12 sockets on the front. If the bus interface is the final subscriber on the line, one M12 socket can remain unoccupied. The use of EMC cable glands is recommended.

PIN	Signal	Description
1	TX+	Transmission Data +
2	RX+	Receive Data +
3	TX-	Transmission Data -
4	RX-	Receive Data -

PIN assignment
M12-4 socket
("D"- coded)

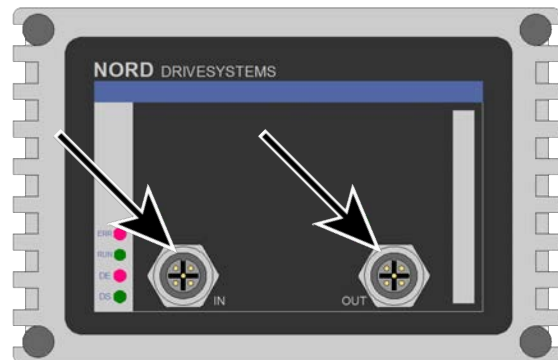

The connection to other signal and control lines takes place via the bus connection unit **SK TI4-TU-BUS(-C)**.

Terminals	Double-sprung terminal bar	2 x 18 contacts
Cable cross section	AWG 14-26	rigid: 0,14 ... 2,5 mm flexible: 0.14 ... 1.5 mm with wire end sleeves
PE connection	Via housing	
RJ12	RJ45 - socket	Interface for connecting a parameterisation tool

NOTICE

Short circuit possible

Attention must be paid to the fact that the GND connection (terminals 7 and 8) on the blue block is basically *not* short-circuit protected. In case of a short circuit between the 24 V connection (terminals 9 and 10) and the GND connection, the module may become defective.

- To remain short-circuit protected, the GND connection of the grey block must be used, even if the remaining connections are applied to the blue block.

Potential	Contact	Designation	Description	
1	Digital inputs	1	24 V	Supply potential (+24 V, ≤ 200 mA)
		2	24 V	Supply potential (+24 V, ≤ 200 mA)
		3	DIN5	Digital input 5
		4	DIN7	Digital input 7
		5	DIN6	Digital input 6
		6	DIN8	Digital input 8
		7	0 V	Reference potential (0 V / GND)
		8	0 V	Reference potential (0 V / GND)
		9	24 V	Supply potential (+24 V, ≤ 200 mA)
		10	24 V	Supply potential (+24 V, ≤ 200 mA)
2	System bus level and digital inputs	11	24 V	Supply voltage (+24 V)
		12	24 V	Supply voltage (+24 V)
		13	24 V	Supply voltage (+24 V)
		14	SYS +	System bus data line +
		15	0 V	Reference potential (0 V / GND)
		16	SYS -	System bus data line -
		17	0 V	Reference potential (0 V / GND)
		18	0 V	Reference potential (0 V / GND)
		19	DIN1	Digital input 1
		20	DIN3	Digital input 3
		21	0 V	Reference potential (0 V / GND)
		22	0 V	Reference potential (0 V / GND)
		23	24 V	Supply voltage (+24 V)
		24	24 V	Supply voltage (+24 V)
		25	DIN2	Digital input 2
		26	DIN4	Digital input 4
		27	0 V	Reference potential (0 V / GND)
		28	0 V	Reference potential (0 V / GND)
		29	24 V	Supply voltage (+24 V)
		30	24 V	Supply voltage (+24 V)
3	Digital outputs	31	VI 24V2	Supply potential (+24 V - in) of the digital outputs
		32	0V2	Reference potential (0 V / GND) of the digital outputs
		33	DOUT1	Digital output 1 (+24 V, ≤ 200 mA)
		34	DOUT2	Digital output 2 (+24 V, ≤ 200 mA)
		35	0V2	Reference potential (0 V / GND) of the digital outputs
		36	0V2	Reference potential (0 V / GND) of the digital outputs
4	Diagnosis	RJ12 - 1	RS485_A	Data cable RS485
		RJ12 - 2	RS485_B	Data cable RS485
		RJ12 - 3	GND	Reference potential (GND)
		RJ12 - 4	RS232_TxD	Data cable RS232
		RJ12 - 5	RS232_RxD	Data cable RS232
		RJ12 - 6	24 V	Supply voltage (+24 V)

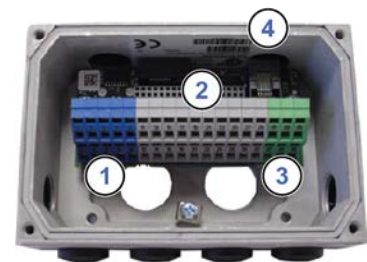

Connection examples

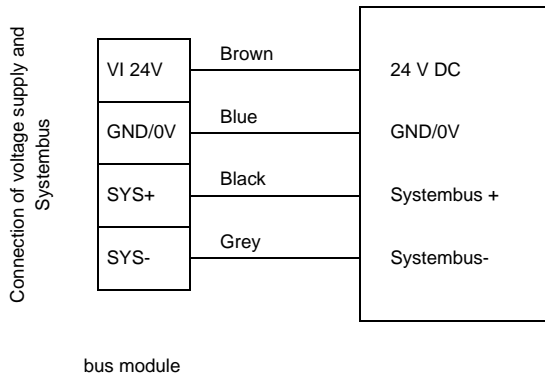

Configuration

The basic configuration of the module is primarily carried out via its DIP switches. The DIP switch settings are read after a "Power On" of the bus interface.

DIP switch												Meaning
12	11	10	9	8	7	6	5	4	3	2	1	Address
X	X	X	0	0	0	0	0	0	0	0	X	0
X	X	X	0	0	0	0	0	0	0	1	X	1
X	X	X	0	0	0	0	0	0	1	0	X	2
X	X	X	0	-	-	-	-	-	-	-	X	-
X	X	X	1	1	1	1	1	1	1	1	X	255
											0	System bus terminating resistor not set.
											1	System bus terminating resistor set.
Access rights for remote maintenance												
		0										Only read access to parameters possible.
		1										Read and write access to parameters possible.
		0										No control possible.
		1										Control is possible.
0												TCP/IP open connection.
1												Secure TCP/IP connection.

1. System bus (DIP 1)

The system bus must be terminated at both physical ends.

2. IP address (DIP 2 ... 9)

The final byte of the IP address can be set via this switch and is controlled in parameter **P185**. However, parameter **P165** must be set to the default setting (setting value "0").

3. Access rights for remote maintenance (DIP 10 ... 12)

The bus interface and the connected frequency inverter can be accessed using remote maintenance via the Ethernet TCP and UDP protocols. The type of access is defined via the DIP switch with inputs 10 to 12.



Factory settings DIP switches: **OFF**

LED indicators

The operating statuses of the bus interface are visualised using LED indicators.

No.	Name	Colour	Meaning
1	MS	dual (red/green)	Module State
	NS	dual (red/green)	Network State
	DS	green	Device State
	EN	red	Device error
2	Link	green	Link
	Activity	yellow	Activity



EtherNet/IP-specific LEDs

MS (Module State)	Meaning
OFF	No operating voltage
Flashing green	Bus interface not configured
Green	Bus interface working correctly
Flashing red	Minor error, faulty configuration
Red	Unrecoverable error
Flashing red/green	Power up, self test

NS (Network State)	Meaning
OFF	No operating voltage
Flashing green	IP address configured but no CIP connection available
Green	CIP connection(s) available
Flashing red	Time-out, an "exclusive owner connection" has a time-out error
Red	Dual IP whose IP address is already being used by the bus interface
Flashing red/green	Power up, self test

Link (Green LED)	Activity (Yellow LED)	Meaning
OFF	OFF	<ul style="list-style-type: none"> Bus interface not ready, no control voltage No bus connection (check cable connection)
ON	OFF	<ul style="list-style-type: none"> Bus connection (cable connection) to another Ethernet device exists No bus activity present
ON	Flashing (Blinking)	<ul style="list-style-type: none"> Bus connection (cable connection) to another Ethernet device exists Bus activity present

NORD-specific LEDs

DS (Device State)	EN (Device Error)	Meaning long flashing = 0.5 s on / 1 s off short flashing = 0.25 s on / 1 s off
OFF	OFF	Bus interface not ready, no control voltage
ON	OFF	Bus interface ready, no error, at least one frequency inverter is communicating via the system bus
ON	Short flashing	Bus interface ready, but <ul style="list-style-type: none"> One or more of the connected frequency inverters has fault status
Long flashing	OFF	Bus interface ready and at least one other subscriber is connected to the system bus, but <ul style="list-style-type: none"> No frequency inverter on the system bus (or connection interrupted) One or more system bus subscriber has an address error Software incompatible (bus interface software and FI software incompatible - update required)
Long flashing	Short flashing Flash interval 1 x - 1s pause	System bus is in status "Bus Warning" <ul style="list-style-type: none"> Communication on system bus disrupted No other subscribers present on system bus Module not inserted correctly or no connection to system bus Frequency inverter has no supply voltage
Long flashing	Short flashing Flash interval 2 x - 1s pause	System bus is in status "Bus Off" <ul style="list-style-type: none"> The system bus 24 V power supply has been interrupted during operation
Long flashing	Short flashing Flash interval 3 x - 1s pause	System bus is in status "Bus Off" <ul style="list-style-type: none"> The 24V voltage supply of the system bus is missing
Long flashing	Short flashing Flash interval 4 x - 1s pause	Bus interface error <ul style="list-style-type: none"> See parameter P170
OFF	Short flashing Flash interval 1...7 - 1s pause	System error, internal program sequence interrupted <ul style="list-style-type: none"> EMC interference (observe the wiring guidelines!) Bus interface defective

Error messages

Error messages from the bus interface - current or archived message relating to the last fault - can be read out via bus interface parameter **P170**. The error messages are lost if the bus interface is switched off.

Error	Meaning	Remarks
100.0	EEPROM error	EMC faults, bus interface defective
102.0	Timeout	via P151/P513 monitoring
103.0	System bus BUS OFF	No 24 V supply to the bus, connections not correct
104.0	Module temperature > 97 °C	SK CU4-... only, permissible internal temperature of bus interface exceeded for approx. 60 sec
550.1	DIP switch error	The DIP switches (IP address) could not be read correctly
560.0 ... 560.9	Internal error	Bus interface not ready
561.0	General network error	
561.1	Ethernet Watchdog timeout	
561.2	Bus cable fault	Bus cable connection interrupted
561.3	IP address error	IP address of bus interface has been doubly assigned
563.0	Firmware version incompatible	The firmware version cannot be used for the device
564.0	MAC address error	

Bus interface-related errors are depicted as follows in the error memory of the frequency inverter (**P700 / P701**).

Error (E010)	Meaning	Remarks
10.0	Connection error	Contact to SK xU4 lost
10.1	ASIC error	Communication to Ethernet - ASIC lost <ul style="list-style-type: none"> • Supply voltage shut-off • for SK CU4-... e.g.: Temperature > 97 °C
10.2	Ethernet/IP Watchdog timeout	Telegram transfer error <ul style="list-style-type: none"> • Check the connections and links, program sequence and Bus Master
10.3	Timeout by P151/P513	Telegram transfer error <ul style="list-style-type: none"> • Check the connections and links • Check the Watchdog time
10.4	IP address error	IP address of bus interface has been doubly assigned
10.5	Internal error	Bus interface not ready
10.6	Bus cable fault	Bus cable connection interrupted
10.8	The connection between inverter and bus interface had timeout	SK TU3 bus interface only
10.9	Bus interface missing (P120)	SK xU4 bus interface only

Parameters

Frequency inverter: The following frequency inverter parameters must be adapted for setting up communication between the frequency inverter and the bus interface (for details please refer to the frequency inverter manual).



Parameter [-Array]	Meaning	Remarks	
P120 [-01]	Option monitoring	"Auto" (default setting)	Only SK xU4
P509	Source Control Word	SK TU3-... on SK 5xxE: "Ethernet TU" SK xU4-... on SK 180/SK 2xxE: "System bus"	
P510 [-01]...[-02]	Setpoint source	"Auto" (default setting)	
P513	Time-out	Monitoring of the SK TU3 bus interface	Only SK 5xxE
P543 [-01]...[-03] ([-05]) and P543...P545	Bus actual value (1...3 (...5))	Possible settings according to P418	
P546 [-01]...[-03] ([-05]) and P546...P548	Bus setpoint value (1...3 (...5))	Possible settings according to P400	
P700 [-01]/P701	Current/last faults	Information parameter	
P740/P741	Process data bus In / Out	Information parameter	
P745	Module version	Information parameter	Only SK TU3
P746	Module status	Information parameter	Only SK TU3
P748	CANopen/System bus status	Information parameter	

Bus interface: The bus interface provides a selection of appropriate parameters for setting or displaying special operating values. Parameters can be adapted using the NORDCON software or an SK PAR-3H / -3E parameter box. All parameters can still be read and written by the bus master via EtherNet/IP.

Parameter [-Array]	Meaning	Remarks	-TU3-	-TU4-	-CU4-
P150	Set relays	Set DOUT directly or control via BUS		X	
P151	External bus time-out	Monitoring of SK xU4 bus interface		X	X
P152	Factory setting	Reset bus interface parameters	X	X	X
P153 [-01 ... -02]	Minimum system bus cycle	Reduction of bus load on the system bus caused by the bus interface		X	X
P154 [-01 ... -02]	Access to option card I/O	Administration of read and write permissions to the IOs of the bus interface		X	X
P160 [-01...-04]	IP address	Alternative to setting the array value [-04]: DIP switch, → Value from DIP-switch has priority	X	X	X
P161 [-01...-04]	IP subnet mask		X	X	X
P164 [-01...-04]	IP Gateway		X	X	X
P165	Addressing mode	Setting "0" = value from DIP-switch or P160 (default setting)	X	X	X
P166	Process data transmit format	Leave at default setting	X	X	X
P169	Password		X	X	X
P170 [-01 ... -02]	Present errors	Display bus interface errors	X	X	X
P171 [-01 ... -03]	Software version	Firmware version / Revision	X	X	X
P172	Configuration	Bus interface type	X	X	X
P173	Module status	Status of system bus or the connected FI	X	X	X
P174	Status of digital inputs	Image of the switching status of DIN		X	X
P175	Digital output state	Image of the switching status of DOUT		X	
P176 [-01...]	Process data bus In	Information parameter	X	X	X
P177 [-01...]	Process data bus Out	Information parameter	X	X	X
P178	Internal temperature	Information parameter			X
P180 [-01 ... -02]	Active assembly	Information parameter	X	X	X
P181 [-01 ... -06]	MAC address	Information parameter	X	X	X
P185 [-01 ... -04]	Present IP address	Information parameter	X	X	X
P186 [-01 ... -04]	Current IP subnet mask	Information parameter	X	X	X

Parameter access and diagnostics

The NORD CON software and optional control units such as the SK PAR-3H parameter box provide convenient access to the parameters of the bus interface and allow status information to be read out.

SK TU3-	SK TU4-	SK CU4- / SK TU4-
Access via RJ12 diagnostics socket of the SK 5xxE 	Access via RJ12 diagnostics socket of the bus connection unit SK TI4-TU-BUS(-C) 	Access via RJ12 frequency inverter diagnostics socket, if connected to the bus interface via the system bus. 

Further documentation and software (www.nord.com)

Software	Description
EDS - file	Electronic Data Sheet (Object data file)

Software	Description
NORD CON	Parametrisation and diagnostic software

Document	Description
BU 0000	Description of NORD CON software
BU 0040	Parameter box manual
BU 0180	Frequency inverter manual SK 180E, SK 190E
BU 0200	Frequency inverter manual SK 2xxE

Document	Description
BU 2100	Ethernet/IP bus communication manual
TI 275280000	Bus connection unit SK TI4-TU-BUS
TI 275274505	SK TIE4-M12-SYSS System bus connection expansion exit
TI 275274506	SK TIE4-M12-SYSS System bus connection expansion entrance