

GETRIEBEBAU NORD

Member of the NORD DRIVESYSTEMS Group



Getriebebau NORD GmbH & Co. KG

Getriebebau-Nord-Straße 1 • 22941 Bargteheide, Germany • www.nord.com

SK TU4-PNS-C

Part number: 275 281 166

PROFIsafe® – Bus interface

The bus interface may only be installed and commissioned by qualified electricians. An electrician is a person who, because of their technical training and experience, has sufficient knowledge with regard to

- Switching on, switching off, isolating, earthing and marking power circuits and devices,
- Proper maintenance and use of protective devices in accordance with defined safety standards.



Danger of electric shock

The frequency inverter carries hazardous voltage for up to 5 minutes after being switched off.

- Work must not be carried out unless the frequency inverter has been disconnected from the voltage and at least 5 minutes has elapsed since the mains was switched off.

Validity of document

This document is only valid in conjunction with the operating instructions of the respective frequency inverter and the bus communication manual for this bus interface (📖 See overview at end of document). These documents contain all of the information that is required for safe commissioning of the bus interface module and the frequency inverter.

Scope of delivery

1 x	Bus interface	SK TU4-PNS-C
4 x	Hexagonal socket screw	M4 x 40 mm
Required accessories:		
1 x	Bus connection unit TI 275280800	SK TI4-TU-SAFE-C (Part no.: 275280800)



Technical Information / Datasheet		SK TU4-PNS-C			
PROFIsafe bus interface		TI 275281166	V 1.4	3821	en

Field of use

External technology unit for connecting a decentralised frequency inverter (SK 2xxE) to a **PROFIsafe** field bus. The bus interface can be mounted on or in the immediate vicinity of the frequency inverter. It is connected to the frequency inverter via the system bus.

The bus interface can directly control up to four frequency inverters via PROFINET IO based on the system bus.

Two secure digital inputs, two clock outputs and three secure digital outputs are available. Therefore a maximum of three frequency inverters (devices with safe inputs) can be directly controlled via the safe outputs of the bus interface.

Technical Data

Applied standards

"Functional safety" standards	EMC standards
EN ISO 13849-1	EN 61326-1: 2013 ¹⁾
EN 62061	EN 61326-3-1: 2008
EN 61508 Part 1-7	

¹⁾ With regard to resistance from interference due to electromagnetic fields, in the range of 80 MHz to 1 GHz, the module is only suitable for the basic electromagnetic environment. The safety criterion according to EN 61326-3-1 is not affected.

Bus interface

Temperature range	-25 °C...40 °C
Temperature class	Class 3k4
Protection class	IP66
Supply voltage	24 V + 25 % / - 20 %, ≈ 140 mA reverse polarity protected

Vibration resistance	3M7
Firmware (PROFINET)	V2.1 R1
Firmware (PROFIsafe)	V1.5 R0
Dimensions [mm] ¹⁾	H x W x D: 95 x 136 x 109

¹⁾

- Bus interface fitted to bus connection unit
- Depth: 154 mm with cover caps at RJ45 connection

		Key values according to	
		EN 62061 / IEC 61508	EN ISO 13849-1
Classification / Basic standards		Up to SIL 3 according to IEC 61508 ¹⁾	PL e ¹⁾
Operating mode		"High demand" according to IEC 61508	
Probability of a hazardous failure per hour (PFH value)	SI, SO	3 x 10 ⁹ 1/h	
	Sin/Cos encoder	30 x 10 ⁹ 1/h	
Operational life		20 years	
Proof test interval		20 years	-

1)

 **WARNING**
Loss of safe function

- An external cross circuit between + 24 V and a safe input (SI) is not detected!
- An external cross circuit between + 24 V and a safe output (SO) results in the module being switched off with an error message to the fail-safe control. The applied 24 V cross circuit is, however, not switched off!

If an exclusion of errors by means of safe wiring is not possible, both the safe input as well as the safe output can be connected with two channels. Double channel operation must be set by parameterisation.

Bus specification

PROFIsafe	Max. 100 MBaud
	Electrical isolation 500 V _{eff}
Bus connection	2 x RJ45
Bus termination	Automatically
Status display	6 LED
Topology	Star, tree, ring, line

Cable	Min. Ethernet CAT-5
Max. cable length	100 m between two bus interfaces
Shield	See Shielding information
PE port	Via PE screw terminal in connection box

 **Information**
Wiring / Shielding

The wiring between the bus module and the frequency inverter must comply with the section "**Exclusion of wiring errors**" in the **Functional Safety** section of the manual for the particular frequency inverter ([BU 0230](#) / [BU 0235](#) / [BU 0530](#)).

The PE is connected to the various circuit board levels via the screw fastenings of the circuit boards.

- Shielding of the bus cable is connected directly to PE via the RJ45 connection.
- Shielding of the IOs must be connected to the PE connection (PE screw terminal in the connection box).
- A separate cable with its own shielding must be used for the digital outputs.

Power

Update interval for process data between bus interface and frequency inverter	≥ 5 ms
Parameter read access to frequency inverter	≈ 15 ms
Parameter write access with saving in EEPROM	≈ 25 ms
Cycle times	≥ 1 ms

Additional information for SAFE

Topic	Specification	Unit	Min.	Typical	Max.
Voltage supply	Voltage supply to the module via a safely isolated power supply unit (SELV or PELV). • Fuse protection required (fuse (8 A))	[V]	19.2	24	30
	• 24 V consumption of SK TU4-PNS-C when idle	[mA]		140	
	• Additional requirement for digital outputs and clock outputs (for details, also refer to “Digital outputs”)				1000
	• Additional requirement for SIN/COS encoder supply (depends on manufacturer)				150
Digital outputs	Low Signal output voltage	[V]		0	0.8
	High Signal output voltage	[V]	17	24	30
	Output current (OSSD 1...3) ^{1, 2)} peak	[mA]			300 500
	T _{OSSD} = Test pulse cycle	[ms]	50	50	50
	t _{OSSDoff} = Pulse length (variable in 200 µs steps)	[ms]	0.3	0.5	2.0
	t _{OSSDon} = Pulse pause (t _{OSSDoff} x 2)	[ms]	0.8	1.2	4.0
	t _{OSSDerror} = Detection of an OSSD error t _{OSSDerror} = T _{OSSD} x 3	[ms]	100	-	150
Digit inputs	Low Signal input voltage	[V]	-3	0	5
	High Signal input voltage	[V]	15	24	30
	High Signal input current	[mA]			6
	Reaction time	[ms]			30
	T _{OSSD} = Test pulse cycle (contact test)	[ms]	50		
	t _{Testoff} = Pulse length	[ms]	0.3	0.5	2.0
	Switch-on delay	[ms]	0	0	100
Clock outputs	Low Signal output voltage	[V]		0	0.8
	High Signal output voltage	[V]	17	24	30
	Output current	[mA]			50
	T _{Takt} = Test pulse cycle	[ms]	50		
	t _{Taktoff} = Pulse length	[ms]			2.0
Encoder	Voltage supply	[V]	19.2	24	30
	Input voltage (sin/cos)	[V]	2.25		2.75
	Maximum encoder frequency	[kHz]			150
Temperatures	Ambient temperature	[°C]	-25		40
	Bearing temperature	[°C]	-25		85
Protection class	Dust-tight and protected against (strong) water jets	IP	55	55	66

1 A maximum of 1 A can be provided for the three OSSD outputs and two clock outputs. The typical power for the STO control of the NORDAC FLEX is 125 mA (see [BU 0230](#)) (average value). This leaves a total of 875 mA for the remaining outputs. The respective limits of the outputs (300 mA for OSSD and 50 mA per clock output) must be taken into account.

The average values of the current loads of the STO controls are considered here. Short-term peak loads with STO control (500 mA, see [BU 0230](#)) are neither affected by the limit of the individual OSSD output (300 mA) nor by the max. current sum 1 A. Thus, a maximum of three STO controls can be operated by three different inverters with one module.

2 If the NORDAC FLEX with STO is used, the SO3 / OSSD3 will always be used for the STO.

Bus interface characteristics

Communication	RT (Real Time) → Real time communication of process data
	IRT (Isochronous Real Time) → Isochronous real time communication of synchronised process data
Addressing PROFINET IO	Automatic address assignment via IO controller using DCP (Discovery Configuration Protocol)
Data transfer	via Switched Ethernet
Autonegotiation	Negotiation of transfer parameters
Autocrossover	Transmission and receiver cables are automatically crossed in the switch as necessary
Conformity classes	CC-B and CC-C
Access for NORD diagnosis tool via	<ul style="list-style-type: none"> • Diagnostics socket on the device (if available) and via frequency inverter • Ethernet protocols UDP or TCP/IP possible

Safety communication	Monitoring of process data, sequential numbering of PROFIsafe telegrams (24-bit counter) and checksum test (CRC)
PROFIsafe addressing	F address via DIP - switches

Installation

The bus interface must be attached to a suitable connection unit (SK TI4-TU...) and connected using the 4 provided M4 x 40 mm hexagon socket collar screws. Installation details can be found in the data sheet for the relevant connection units.

Connections

The two Ethernet lines are connected exclusively via the two RJ45 sockets on the front. If the module is the final participant on the line, one RJ45 socket can remain unoccupied.

RJ45 PIN	Signal	Description
1	TX+	Transmission Data +
2	TX-	Transmission Data -
3	RX+	Receive Data +
6	RX-	Receive Data -

PIN connections
RJ45 socket:

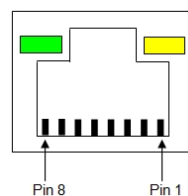

Connection of the other signal and control cables is made via the Bus: connection unit **SK TI4-TU-SAFE(-C)**

Terminals	Double spring-loaded terminal bar	2 x 18 contacts
Cable cross section	AWG 14-26	rigid: 0.14 ... 2.5 mm flexible: 0.14 ... 1.5 mm with wire end sleeves
PE connection	via housing	
RJ12	RJ12 socket	Interface for connecting parametrisation tool

Area	Contact	Designation	Description	
1	Encoders	1	A Out	Track A for external processing – 24V square wave signal
		2	B Out	Track B for external processing – 24V square wave signal
		3	A+	Differential SIN signal +
		4	B+	Differential COS signal +
		5	A-	Differential SIN signal -
		6	B-	Differential COS signal -
		7	0V	Reference potential (0 V / GND)
		8	0V	Reference potential (0 V / GND)
		9	24V	Supply potential (+24 V, ≤ 200 mA)
		10	24V	Supply potential (+24 V, ≤ 200 mA)
2	System bus level and digital inputs	11	24V	Supply voltage (+24 V)
		12	24V	Supply voltage (+24 V)
		13	24V	Supply voltage (+24 V)
		14	SYS +	System bus data line +
		15	0V	Reference potential (0 V / GND)
		16	SYS -	System bus data line -
		17	0V	Reference potential (0 V / GND)
		18	0V	Reference potential (0 V / GND)
		19	SI1	Safe digital input 1
		20	SI2	Safe digital input 2
		21	0V	Reference potential (0 V / GND)
		22	0V	Reference potential (0 V / GND)
		23	24V	Supply voltage (+24 V)
		24	24V	Supply voltage (+24 V)
3	Digital outputs	25	Clock 1	Clock output for safe input 1 ¹⁾ (p-switching, OSSD)
		26	Clock 2	Clock output for safe input 2 ¹⁾ (p-switching, OSSD)
		27	0V	Reference potential (0 V / GND)
		28	0V	Reference potential (0 V / GND)
		29	24V	Supply voltage (+24 V)
		30	24V	Supply voltage (+24 V)
		31	SO1	Safe output 1 (pp switching, OSSD)
		32	0V	Reference potential (0 V / GND)
		33	SO2	Safe output 2 (pp switching, OSSD)
		34	SO3	Safe output 3 (pp switching, OSSD)
		35	0V	Reference potential (0 V / GND)
		36	0V	Reference potential (0 V / GND)
4	Diagnostics	RJ12 - 1	RS485_A	Data cable RS485
		RJ12 - 2	RS485_B	Data cable RS485
		RJ12 - 3	GND	Reference potential (GND)
		RJ12 - 4	RS232_TxD	Data cable RS232
		RJ12 - 5	RS232_RxD	Data cable RS232
		RJ12 - 6	5 V	Supply voltage (+5 V)



1) Clock output is not safety-rated.

NOTICE

Defect on the safe output through incorrect connection

The connection of an external voltage to the safe outputs SO1, SO2 and SO3, or to the clock outputs Clock1 and Clock2 may destroy them.

Connection of the cable sets (scope of delivery)

The following cable sets are included in scope of delivery:

- Systembus
- HTL-signal (for signal processing in the frequency inverter) ^{a)}
- Safe Stop
- Voltage supply
- PE

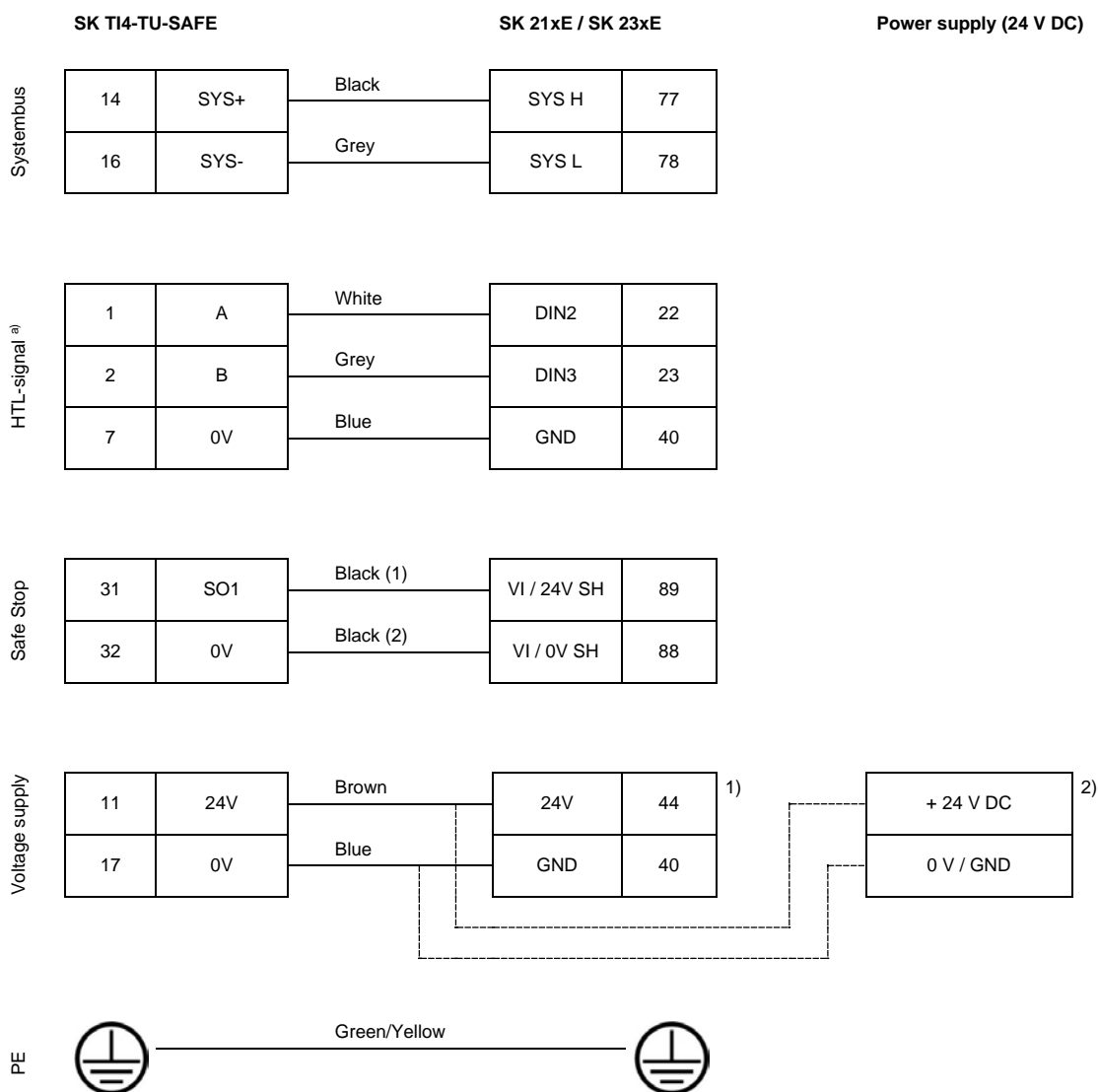

SK TI4-TU-SAFE...

SK 21xE / SK 23xE

Power supply (24 V DC)

1) Only valid for devices SK 215E / SK 235E.

2) For devices SK 210E / SK 230E or for higher power requirements of the bus interface (eg due to IOs) an external power supply have to be used.

a) **REMARK:** Don't connect encoder!

Encoder connection

A safety SIN /COS encoder can be connected to implement the safety functions.

i Information

Measurement precision

The encoder is evaluated by measuring the frequency. The higher the working frequency which is selected, the greater the precision.

To prevent large incorrect measurements, at least 500 measuring steps per second should be selected.

The number of measuring steps per second is calculated from the speed of rotation of the encoder and the selected encoder resolution.

$$inc/s = \frac{RPM \times Resolution}{1500}$$

The following diagram shows the percentage measuring error for the set number of steps.

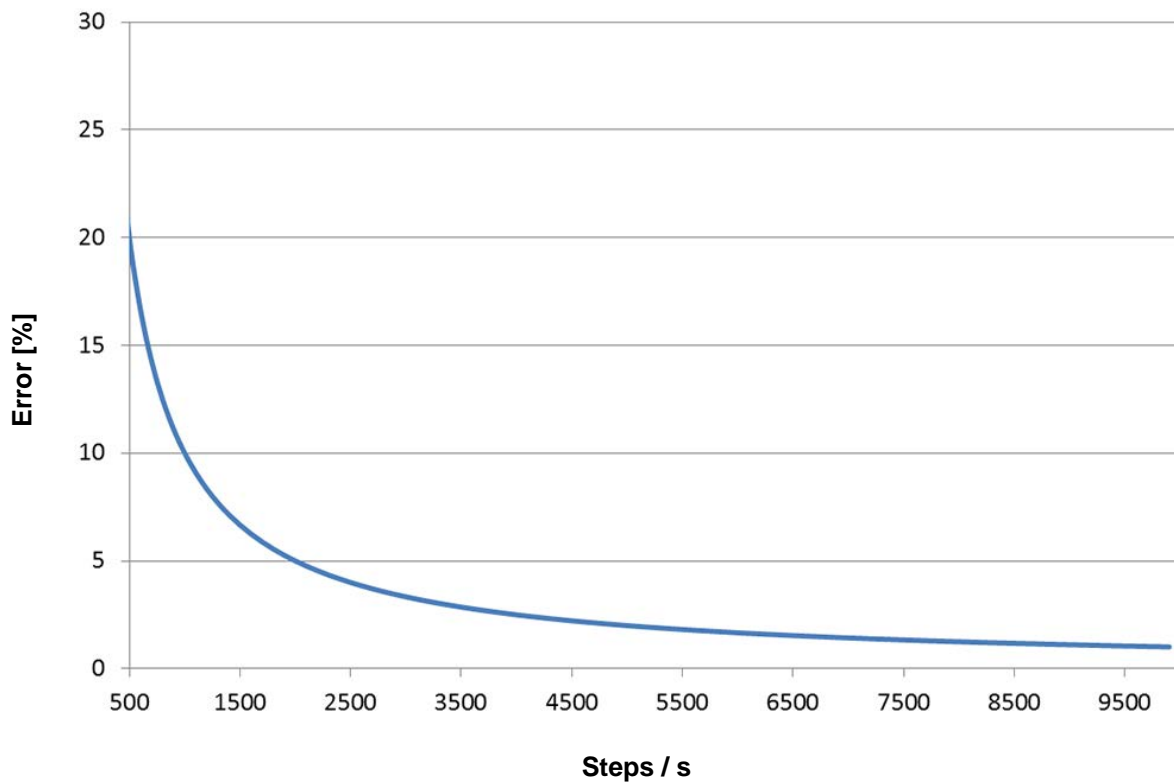

i Information

Standstill detection

With the use of a single encoder for standstill detection, reduced availability is to be expected under unfavourable EMC conditions. This must be taken into account during planning and compensated for by setting a larger maximum position error.

Configuration

Configuration of the module for remote maintenance or for the system bus is carried out via the DIP switches. The DIP - switch settings are read after a "Power On" of the module.

DIP switch												Meaning	
12	11	10	9	8	7	6	5	4	3	2	1		
X	X	X	F-address									X	
												0	System bus terminating resistor not set
												1	System bus terminating resistor set
Access rights for remote maintenance													
		0											Only read access to parameters possible.
		1											Read and write access to parameters possible.
		0											No control possible.
		1											Control is possible.
0													TCP/IP open connection.
1													Secure TCP/IP connection.

1. System bus (DIP 1)

The system bus must be terminated at both physical ends.

2. F-address (DIP 2 - 9)

Setting the F-address

3. Access rights for remote maintenance (DIP 10 – 12)

Via the Ethernet protocols TCP and UDP the module and the connected frequency inverter can be accessed using remote maintenance. The type of access is determined via the DIP - switch with inputs 10 to 12.



Factory settings DIP switches: **OFF**

LED indicators

The operating statuses of the bus interface are visualised using LED indicators.

No.	Name	Colour	Meaning
1	FE	red	F Data Error
	FS	green	F Data State
2	RUN	green	Ethernet State
	BF	red	Ethernet Error
	DS	green	Device State
	EN	red	Device error
3	Link	green	Link
	Act	yellow	Activity

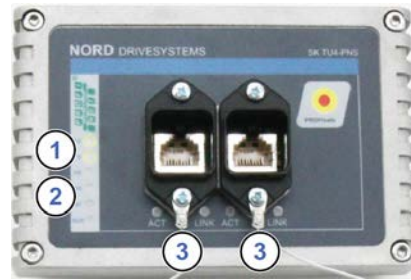

PROFINET-specific LED

RUN (Ethernet State)	Meaning
OFF	No operating voltage Initialisation
Flashing green	No connection to PROFINET IO controller No parameter communication No process data communication
Green ON	Parameter communication active Process data communication active

BF (Ethernet Error)	Meaning
OFF	No error
Flashing red	No process data communication → e.g. incorrect GSDML file
Red ON	Ethernet error → there is no physical connection to a further subscriber
Double-flashing red (2 x 0.25 s,+ 1sec pause)	PROFINET or FU timeout, (see also P151, P513)

Link (Green LED)	Activity (Yellow LED)	Meaning
OFF	OFF	<ul style="list-style-type: none"> Bus interface not ready, no control voltage, No bus connection (check cable connection)
ON	OFF	<ul style="list-style-type: none"> Bus connection (cable connection) to another Ethernet device exists No bus activity present
ON	Flashing (Blinking)	<ul style="list-style-type: none"> Bus connection (cable connection) to another Ethernet device exists Bus activity present

PROFIsafe-specific LED

FS (F Data State)	Meaning
OFF	No operating voltage Initialisation
Brief flashing	No cyclic SAFE data exchange
Flashing	Cyclic exchange of data, bus interface waiting for reintegration
On	Cyclic data exchange in operation

FE (F Data Error)	Meaning
OFF	No error
Red ON	SAFE- bus interface hardware error
Flashing red	PROFIsafe error (for flashing code and error codes see Manual BU 2800)

NORD-specific LEDs

DS (Device State)	EN (Device Error)	Meaning long flashing = 0.5 s on / 1 s off short flashing = 0.25 s on / 1 s off
OFF	OFF	Bus interface not ready, no control voltage
ON	OFF	Bus interface ready, no error, at least one frequency inverter is communicating via the system bus
ON	Short flashing	Bus interface ready, but <ul style="list-style-type: none"> One or more of the connected frequency inverters has fault status
Long flashing	OFF	Bus interface ready and at least one other subscriber is connected to the system bus, but <ul style="list-style-type: none"> No frequency inverter on the system bus (or connection interrupted) One or more system bus subscriber has an address error Software incompatible (bus interface software and FI software incompatible - update required)
Long flashing	Short flashing Flash interval 1 x - 1s pause	System bus is in status "Bus Warning" <ul style="list-style-type: none"> Communication on system bus disrupted No other subscribers present on system bus Module not inserted correctly or no connection to system bus Frequency inverter has no supply voltage
Long flashing	Short flashing Flash interval 2 x - 1s pause	System bus is in status "Bus Off" <ul style="list-style-type: none"> The system bus 24 V power supply has been interrupted during operation
Long flashing	Short flashing Flash interval 3 x - 1s pause	System bus is in status "Bus Off" <ul style="list-style-type: none"> The 24V voltage supply of the system bus is missing
Long flashing	Short flashing Flash interval 4 x - 1s pause	Bus interface error <ul style="list-style-type: none"> See parameter P170
OFF	Short flashing Flash interval 1...7 - 1s pause	System error, internal program sequence interrupted <ul style="list-style-type: none"> EMC interference (observe the wiring guidelines!) Bus interface defective

Error messages

Error messages from the bus interface can be read out via parameter **P170** of the bus interface (Array [-01] = Actual error, Array [-02] = Previous error).

Error	Meaning	Comments
100.0	EEPROM error	EMC fault, bus interface defective
101.0	System bus 24 V missing	No 24 V voltage on bus, connections not correct
102.0	Bus timeout P151	By means of timeout supervision parameter P151
103.0	System bus Off	No 24 V voltage on bus, connections not correct
550.0	General configuration error	No Ethernet connection (see E10.5)
550.2	Hardware error System bus	EMC fault (see E10.6)
550.3	SAFE hardware error	Error in the safety module (see E10.7)
550.4	FI lost	Connection to system bus participant (FI) lost
550.5	AR lost	PROFINET telegram failure, connection to the IO controller lost (see E10.2)
564.0	MAC address error	MAC address defective

Error messages which occur in relation to the bus interface are depicted as follows in the error memory of the frequency inverter (Parameter **P700** and **P701**).

Error (E010)	Meaning	Comments
10.0	Connection error	<ul style="list-style-type: none"> Contact to bus interface lost
10.2	PROFINET telegram failure	<ul style="list-style-type: none"> Check physical bus connections Check the status of the PROFINET IO controller
10.3	Timeout through P151	<ul style="list-style-type: none"> System bus monitoring has triggered. <ul style="list-style-type: none"> Check time setting parameter P151 Telegram transfer is faulty. <ul style="list-style-type: none"> Reception of cyclic telegrams Check physical bus connections
10.5	General PROFINET connection error	<ul style="list-style-type: none"> Connection to the Ethernet lost.
10.6	System bus hardware error	<ul style="list-style-type: none"> Remedy EMC fault
10.7	Hardware error, Safe bus interface	<ul style="list-style-type: none"> An error has occurred in the safe hardware. <ul style="list-style-type: none"> Remedy EMC fault Restart the bus interface
10.8	Timeout connection error	<ul style="list-style-type: none"> Connection between bus interface and frequency inverter interrupted due to timeout.
10.9	Module missing P120	<ul style="list-style-type: none"> The module entered in parameter P120 is not available.

PROFIsafe error messages

Error	Meaning	Remarks
5711	Incorrect client address	DIP switch setting or parameterised target address incorrect
5712	Invalid client address	
5713	Invalid host address	Incorrect source address
5714	Watchdog time is zero	A watchdog time of zero is invalid
5715	Incorrect F-SIL	F-SIL level set too high in the control
5716	Incorrect F-Par version	The F-Par version is not compatible with the bus interface
5717	Incorrect checksum	The checksum for the F-parameter is incorrect
5718	General F-Parameter error	

Error	Meaning	Remarks
5719	Incorrect i-parameter checksum	Different checksum in control and bus interface
5721	Different CRC length	
5722	i-parameters have been changed	
5723	Different i-parameter checksum	The checksum and the i-parameter do not match
5724	Incorrect i-parameter checksum	The checksum and the i-parameter do not match
5725	Incorrect F parameter telegram	
5726	Error when reading in DIP switches	DIP switches possibly set to zero
5731	Discrepancy test	Discrepancy at inputs
5732	Diagnostic error at output 1	Short circuit or cross circuit
5733	Diagnostic error at output 2	
5734	Diagnostic error at output 3	
5735	Diagnostic error at clock output 1	
5736	Diagnostic error at clock output 2	Short circuit, cross circuit or wrong assignment of clock output
5737	Diagnostic error (OSSD) at input 1	
5738	Diagnostic error (OSSD) at input 2	
5741	iPar error OSSD1 channel activation	Output activated without activating channel
5742	iPar error OSSD2 channel activation	
5743	iPar error OSSD3 channel activation	
5744	iPar error Clock Cycle 1 channel activation	
5745	iPar error Clock Cycle 2 channel activation	
5746	iPar error SI1 channel activation	Input activated without activating channel
5747	iPar error SI2 channel activation	
5748	iPar error i-Parameter channel activation	Incorrect setting of P802 Enable Channel
5749	iPar error OSSD signal pulse length	Incorrect setting of parameter P804 OSSD Pulse
5751	iPar error Digital Input filter time	Incorrect setting of parameter P805 Filter Time
5752	iPar error Single/double channel operation	Incorrect setting of parameter P800 I/O operating mode
5753	iPar error Input time discrepancy	Incorrect setting of parameter P803 Discrepancy time
5754	iPar error Passivation	Incorrect setting of parameter P801 Error response
5755	iPar error encoder parameter	Incorrect setting of parameters P810 Encoder , P811 Ratio or P813 Encoder resolution
5756	iPar error SLS activation	Incorrect setting of parameter P820 and/or P810
5757	iPar error SSR activation	
5758	iPar error SDI-P activation	
5759	iPar error SDI-N activation	
5761	iPar error SOS activation	
5762	iPar error Activation time	Incorrect setting of parameter P821 Activation time
5763	iPar error Response time	Incorrect setting of parameter P822 Reaction time
5764	iPar error speed	Incorrect setting of parameter P823 Speed
5765	iPar error Tolerance	Incorrect setting of parameter P824 Max. position offset
5766	iPar error Limit frequency	Incorrect setting of parameter P811 , P812 or P823
5771	Temperature outside of specification	Excess temperature (system error)
5772	Encoder safety condition breached	Error at encoder connection (system fault)
5773	SYNC signal not "Low"	Bus interface synchronisation error (system error)
5774	Supply voltage error	The supply voltage is too high or too low
5775	Supply voltage error	The supply voltage is too high or too low
5776	Speed difference error	The difference between the speeds measured by the two processors is too high
5781	SLS error	The set SLS speed has been exceeded
5782	SSR error	The set SSR speed has been exceeded or undershot
5783	SDI_P error	The encoder has detected a negative direction
5784	SDI_N error	The encoder has detected a positive direction
5785	SOS error	Number of values counted by the encoder larger than the set tolerance
5791	System error saved in flash memory	The triggered system error is saved
5792	Maximum number of system errors	More than 15 system errors have occurred (replace bus interface)
5797	Flash memory access error	Flash memory access error cannot be saved

Parameters

Frequency inverter: The following frequency inverter parameters must be adapted for setting up communication between the frequency inverter and the bus interface (for details please refer to the frequency inverter manual).

Parameter [-Array]	Meaning	Remarks
P120 [-01]	Option monitoring	"Auto" (default setting)
P509	Source Control Word	"System bus"
P510 [-01]...[-02]	Setpoint source	"Auto" (default setting)
P543 [-01]...[-03]	Bus actual value (1...3)	Possible settings according to P418
P546 [-01]...[-03]	Bus setpoint value (1...3)	Possible settings according to P400
P700 [-01]/P701	Current/last faults	Information parameter
P740/P741	Process data bus In / Out	Information parameter
P748	CANopen/System bus status	Information parameter

Bus interface: The bus interface provides a selection of appropriate parameters for setting or displaying special operating values. Parameters can be adapted using the NORDCON software or an SK PAR-3H / -3E parameter box. All parameters can still be read from and written to by the bus master via PROFINET IO.



Parameter [-Array]	Meaning	Remarks	-TU3-	-TU4-	-CU4-
P150	Set relays	Set DOUT directly or control via bus		X	
P151	External bus time-out	Monitoring of SK xU4 bus interface		X	X
P152	Factory setting	Reset bus interface parameters	X	X	X
P153 [-01 ...]	Minimum system bus cycle	Reduction of bus load on the system bus caused by the bus interface		X	X
P154 [-01 ...]	Access to option card I/O	Administration of read and write permissions to the IOs of the bus interface		X	X
P160 [-01...]	IP address		X	X	X
P161 [-01...]	IP subnet mask		X	X	X
P162	Device name	Up to 240 characters (ASCII codes 45 ... 122), save by entering "0" as the final character	X	X	X
P163 [-01 ...]	Alarm test	Sets a diagnostic alarm	X	X	X
P164 [-01 ...]	IP Gateway	IP-Address for Gateway functionality	X	X	X
P170 [-01 ...]	Present errors	Indication of a bus interface error	X	X	X
P171 [-01 ...]	Software version	Firmware version/Revision	X	X	X
P172	Configuration	Bus interface type	X	X	X
P173 [-01 ...]	Module status	Status of system bus or the connected FI	X	X	X
P174	Status of digital inputs	Image of the switching status of DIN		X	X
P175	Digital output state	Image of the switching status of DOUT		X	
P176 [-01...]	Process data bus In	Information parameter	X	X	X
P177 [-01...]	Process data bus Out	Information parameter	X	X	X
P178	Internal temperature	Information parameter			X
P180 [-01 ...]	PPO Type	Information parameter	X	X	X
P181 [-01 ...]	MAC address	Information parameter	X	X	X
P185 [-01 ...]	Present IP address	Information parameter	X	X	X
P186 [-01 ...]	Current IP subnet mask	Information parameter	X	X	X
P187 [-01 ...]	Actual IP Gateway	Information parameter	X	X	X
P190	Status DIP-switches	Information parameter	X	X	X

Additional parameters for PROFIsafe

Parameter [array]	Meaning	Remarks		-TU4-	-CU4-
P800 [-01...]	I/O operating mode	Digital input/output operating mode: single or double channel		X	X
P801	Error response	Safe output response to an error		X	X
P802 [-01...]	Enable Channel	Activate inputs and outputs		X	X
P803	Discrepancy time	Permissible time difference for double-channel mode (→P800)		X	X
P804	OSSD Pulse	Pulse width for testing outputs		X	X
P805	Filter Time	Filter time for digital inputs SI1 and SI2		X	X
P806	Cycletime monitoring	Monitoring of clock outputs by coupled safety input.		X	X
P810	Encoder	Activate encoder evaluation		X	X
P811	Ratio	Set speed ratio "motor speed/encoder speed" (→P810)		X	X
P812	Incremental encoder	Set encoder resolution		X	X
P820 [-01...]	Safety function	Switch safety functions On/Off		X	X
P821 [-01...]	Activation time	Safety function activation time (→P820)		X	X
P822 [-01...]	Reaction time	Reaction time of safety function (→P820) to an error		X	X
P823 [-01...]	Speed limit	Set the speed limit for safety functions (→P820)		X	X
P824 [-01...]	Max. position offset	Set maximum position deviation for safety function		X	X
P830	Save I-Para	Save settings P800...P824 in flash memory		X	X
P831	F-Address	Setting the F-Address.		X	X
P840	I-Para CRC	Display i parameter checksum (CRC)		X	X
P841	Current fault	Display of the actual error present		X	X
P842	Last fault	Display last error		X	X
P843	Software-Version	Display software version		X	X
P844 [-01...]	Temperature	Display actual temperature of bus interface		X	X
P845 [-01...]	Current voltage	Display current voltage of bus interface		X	X
P846 [-01...]	Status Dip-switches	Display DIP - switch settings		X	X
P847	Speed	Display the speed measured by the encoder		X	X
P848 [-01...]	System error	Display system errors (incl. total number of errors)		X	X

Parameter access and diagnostics

The NORD CON software and optional control units such as the SK PAR-3H parameter box provide convenient access to the parameters of the bus interface and allow status information to be read out.

SK TU3-	SK TU4-	SK CU4- / SK TU4-
Access via RJ12 diagnostics socket of the SK 5xxE	Access via RJ12 diagnostics socket of the bus connection unit SK TI4-TU-SAFE(-C)	Access via RJ12 frequency inverter diagnostics socket, if connected to the bus interface via the system bus.
		

Further documentation and software (www.nord.com)

Software	Description
GSDML-file	Device characteristics and parameters

Software	Description
NORD CON	Parametrisation and diagnostic software

Document	Description
BU_0000	Description of NORD CON software
BU_0040	Parameter box manual
BU_0200	Frequency inverter manual SK 2xxE

Document	Description
BU_2800	PROFsafe bus communication manual
TI_275280800	Bus connection unit SK TI4-TU-SAFE-C