

GETRIEBEBAU NORD

Member of the NORD DRIVESYSTEMS Group



Getriebebau NORD GmbH & Co. KG

Getriebebau-Nord-Straße 1 • 22941 Bargteheide, Germany • www.nord.com

SK CU4-DEV

Part number: 275 271 002

DeviceNet® – Internal Bus Interface

The bus interface may only be installed and commissioned by qualified electricians. An electrician is a person who, because of their technical training and experience, has sufficient knowledge with regard to

- Switching on, switching off, isolating, earthing and marking power circuits and devices,
- Proper maintenance and use of protective devices in accordance with defined safety standards.

DANGER

Danger of electric shock

The frequency inverter carries hazardous voltage for up to 5 minutes after being switched off.

- Work must not be carried out unless the frequency inverter has been disconnected from the voltage and at least 5 minutes has elapsed since the mains was switched off.

Validity of document

This document is only valid in conjunction with the operating instructions of the respective frequency inverter and the bus communication manual for this bus interface (📖 See overview at end of document). These documents contain all of the information that is required for safe commissioning of the bus interface module and the frequency inverter.

Scope of delivery

1 x	Bus interface	SK CU4-DEV
1 x	System bus cable set	grey/black
1 x	24 VDC cable set	brown/blue
2 x	Connecting screws	M4 x 20, cross-head



Usage area

Internal interface for connecting a decentralised frequency inverter (NORDAC *BASE*, NORDAC *FLEX*, NORDAC *LINK*) to a **DeviceNet** field bus. This is connected to the inverter via the system bus, and can directly access up to 4 frequency inverters. 2 digital inputs are available.

Technical Information / Datasheet	SK CU4-DEV			
DeviceNet Bus module	TI 275271002	V 1.3	0623	en

Technical Data

Bus interface

Temperature range	-25 °C...50 °C	Vibration resistance	3M7
Temperature class	Class 3K3	Protection class	IP20
		Supply voltage	24 V ± 20 %, ≈ 100 mA Reverse polarity protected

Digital input - working range	Low: 0 V ... 5 V, High: 15 V ... 30 V
Digital input - specific data	R _i = 8.1 kΩ, input capacity: 10 nF, response time 1 ms, inputs as per EN 61131-2 type 1

Bus specification

DeviceNet	Max. 500 kBit/s								
	electrical isolation 500 V _{eff}								
Bus connection	Screw terminals								
Bus termination	via DIP switch on the bus interface								
Status display	6 LEDs								
Topology	Linear bus								
Cable	twisted, shielded two-conductor cable								
Cable length	depending on transmission speed:								
	<table border="1" data-bbox="470 1077 933 1205"> <thead> <tr> <th>Bus cable length</th> <th>Transfer rate</th> </tr> </thead> <tbody> <tr> <td>Up to 100 m</td> <td>500 KBit/s</td> </tr> <tr> <td>100...250 m</td> <td>250 KBit/s</td> </tr> <tr> <td>250...500 m</td> <td>125 KBit/s</td> </tr> </tbody> </table>	Bus cable length	Transfer rate	Up to 100 m	500 KBit/s	100...250 m	250 KBit/s	250...500 m	125 KBit/s
	Bus cable length	Transfer rate							
	Up to 100 m	500 KBit/s							
100...250 m	250 KBit/s								
250...500 m	125 KBit/s								
Shield	Direct to PE								
PE connection	via PE screw cap in terminal box								

Power

Update interval for process data between bus interface and frequency inverter	≥ 5 ms
Parameter read access on the frequency inverter	< 12 ms
Parameter write access with storage in EEPROM	≈ 25 ms

Bus interface characteristics

Parametrisation	DeviceNet via Explicit Messages
Addressing	SK TU3-DEV SK xU4-DEV
	via Rotary coding switch via DIP switch
Setting the baud rate	SK TU3-DEV SK xU4-DEV
	via Rotary coding switch via DIP switch
Supported DeviceNet connection types	Explicit Messaging Connection
	Polled I/O Connection
	Bit Strobe I/O Connection
	Change of State/Cyclic I/O Connection
Access for NORD diagnosis tool via	diagnostics socket on the device (if available) and via frequency inverter

Installation

Installation location	In defined option slot inside the NORDAC device.
Fastening	with screw fastenings

1) With NORDAC *LINK*, this assembly must be selected when ordering. The installation is then carried out at the factory. Subsequent installation is not possible.

Installation steps

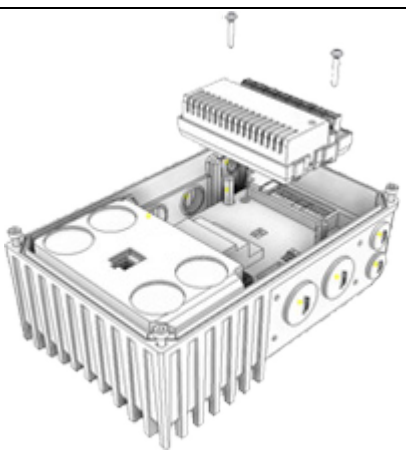
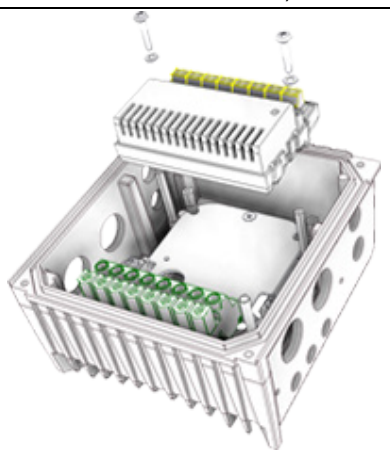
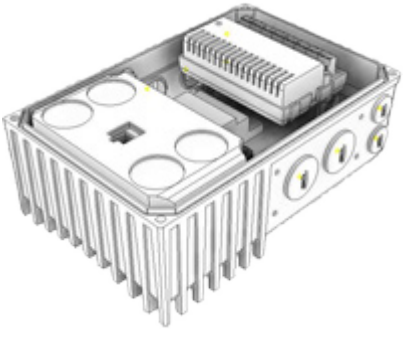
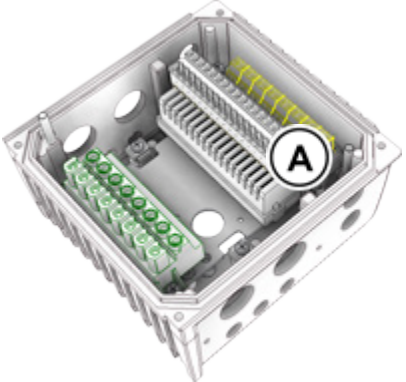
	NORDAC BASE	NORDAC FLEX *)
1.		
2.		

*) Before carrying out installation step 1 it may be necessary to remove the control terminal bar (A),
The control terminal bar (A) must be fitted after installation step 2.

Connections

Connection is via the terminal strip of the bus interface.

Potential	Contact	Designation	Description	
1	System bus level and digital inputs	44	24 V	Supply potential (+24 V ±20%, 50 mA)
		40	GND	Reference potential (0 V/GND)
		C1	DIN1	Digital input 1 (I/O DeviceNet DIN1)
		C2	DIN2	Digital input 2 (I/O DeviceNet DIN2)
		77	Sys +	System bus data line +
		78	Sys -	System bus data line -
		40	GND	Reference potential (0 V/GND)
2	DeviceNet	45	24 V Bus	24 V supply voltage field bus
		75	DeviceNet+	Bus connection 1 Receive Data +
		76	DeviceNet-	Bus connection 1 Receive Data -
		46	GND Bus	Bus reference potential
		90	SHLD	Bus line shield
		45	24 V Bus	Supply potential (+24 V ±20%, 50 mA)
		75	DeviceNet+	Bus connection 2 Transmit Data +
		76	DeviceNet-	Bus connection 2 Transmit Data -
46	GND Bus	Bus reference potential		

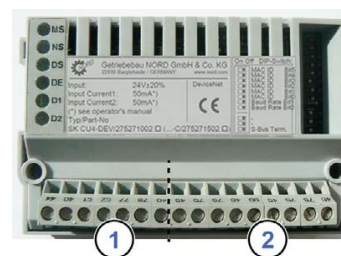

Connection examples

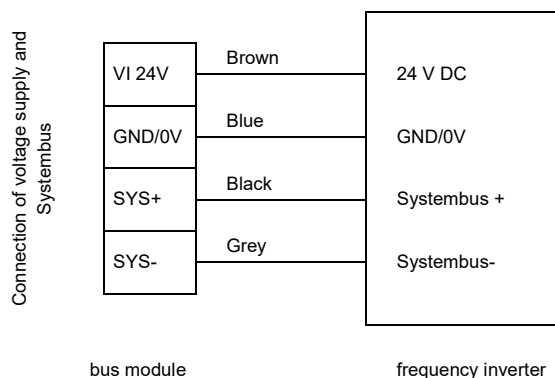

Configuration

The bus address (MAC ID), the bus interface (1) and the baud rate (2) are set via the DIP switches. The DIP switch settings are read in after a “Power On” of the bus interface.

If the bus interface is the final subscriber on the DeviceNet field bus or the NORD system bus, the terminating resistor (3) must be activated.

DIP switch	Meaning	Department	Meaning
8	MAC ID Bit 5	Addressing	Bus address (MAC ID) of bus interface
7	MAC ID Bit 4		
6	MAC ID Bit 3		
5	MAC ID Bit 2		
4	MAC ID Bit 1		
3	MAC ID Bit 0	Baud rate	Bus interface baud rate
2	Baud rate bit 1		
1	Baud rate bit 0	Bus terminal	Not used
3	—		Not used
2	—		Terminating resistor for DeviceNet field bus and NORD system bus
1	S-Bus Term.		

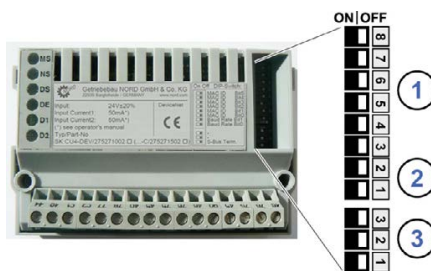

Factory settings DIP switches: **OFF**

1. Addressing (DIP 8 ... 3)

The setting of the bus address takes place with binary coding using DIP switches 8...3.
Address area "0"..."63".

2. Baud rate (DIP 2 ... 1)

The setting of the node ID takes place with binary coding using DIP switches 2...1.

DIP switch 2	DIP switch 1	Baud rate
OFF	OFF	125 kBaud
OFF	ON	250 kBaud
ON	OFF	500 kBaud

3. Termination resistor (DIP 3...1)

Set DIP switch 1 to the “ON” position if the bus interface is the final subscriber on the NORD system bus.
DIP switches “3” and “2” must be in the “OFF” position.

Information

Field bus termination

In accordance with the DeviceNet specification, an external terminating resistor of 120 Ω must be set at each physical end of the DeviceNet field bus.

Information

NORDAC LINK

With the NORDAC LINK, the DIPP switch settings can only be adjusted at the factory. Subsequent adaptation is not possible. The configuration of the module must therefore be defined when ordering.

LED indicators

The operating statuses of the bus interface are visualised using LED indicators.

No.	Name	Colour	Meaning
1	MS	red/green	DeviceNet Module status
	NS	red/green	DeviceNet Network status
2	DS	green	Device State
	EN	red	Device error
3	D1	green	Digital input D1
	D2	green	Digital input D2

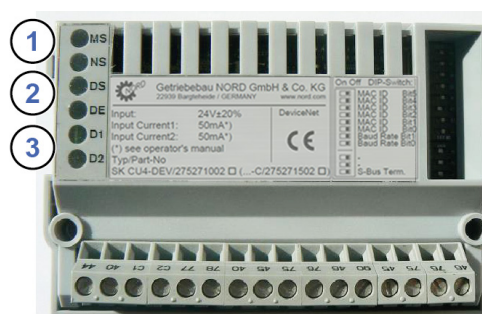

DeviceNet-specific LED

MS (DeviceNet Module status)	Meaning
OFF	No voltage supply
Steady illumination in green	Bus interface ready
Flashing green (0.5 s)	Bus interface in standby mode. No connection to one or more frequency inverters. No parameters exchanged, setpoint specifications via the AC profile not possible. Baud rate setting for DeviceNet field bus is invalid.
Steady illumination in red	A fault that cannot be acknowledged has occurred. The bus interface may be defective and must be replaced.
Flashing red (0.5 s)	A fault that can be acknowledged has occurred on the bus interface.

NS (DeviceNet Network status)	Meaning
OFF	No voltage supply. The bus interface has not performed the "DUP_MAC_ID" test.
Steady illumination in green	Normal operation, cyclic data exchange via DeviceNet field bus.
Flashing green (0.5 s)	Bus interface is "Online" and has performed the "Dup_Mac_ID" test but has not established a connection to field bus subscribers.
Steady illumination in red	A serious communication error has occurred (e.g. bus off, duplicated bus address or invalid baud rate setting).
Flashing red (0.5 s)	The I/O connection or the function of parameter P151 has triggered a timeout error. The flash code is displayed for at least 5 seconds.

NORD-specific LEDs

DS (Device State)	DE (Device Error)	Meaning
		long flashing = 0.5 s on / 1 s off short flashing = 0.25 s on / 1 s off
OFF	OFF	Bus interface not ready, no control voltage
ON	OFF	Bus interface ready, no error, at least one frequency inverter is communicating via the system bus
ON	Short flashing	Bus interface ready, but <ul style="list-style-type: none"> • One or more of the connected frequency inverters has fault status
Long flashing	OFF	Bus interface ready and at least one other subscriber is connected to the system bus, but <ul style="list-style-type: none"> • No frequency inverter on the system bus (or connection interrupted) • One or more system bus subscriber has an address error • Software incompatible (bus interface software and FI software incompatible - update required)
Long flashing	Short flashing Flash interval 1 x - 1 s pause	System bus is in status "Bus Warning" <ul style="list-style-type: none"> • Communication on system bus disrupted • No other subscribers present on system bus • Module not inserted correctly or no connection to system bus • Frequency inverter has no supply voltage
Long flashing	Short flashing Flash interval 2 x - 1 s pause	System bus is in status "Bus Off" <ul style="list-style-type: none"> • The system bus 24 V power supply has been interrupted during operation
Long flashing	Short flashing Flash interval 3 x - 1 s pause	System bus is in status "Bus Off" <ul style="list-style-type: none"> • The 24 V voltage supply of the system bus is missing
Long flashing	Short flashing Flash interval 4 x - 1 s pause	Bus interface error <ul style="list-style-type: none"> • See parameter P170
OFF	Short flashing Flash interval 1 x - 1 s pause	System error, internal program sequence interrupted <ul style="list-style-type: none"> • EMC interference (observe the wiring guidelines!) • Bus interface defective

Digital input LEDs

LED (green)	Display		Meaning
D1	ON		"High" potential present at terminal "C1".
		OFF	"Low" potential present at terminal "C1".
D2	ON		"High" potential present at terminal "C2".
		OFF	"Low" potential present at terminal "C2".

Parameter access and diagnosis

The NORDCON software or optional control units such as the SK PAR-3H ParameterBox provide convenient access to the parameters of the bus interface and allow status information to be read out. In addition, the NORDCON *APP* – in connection with the NORDAC *ACCESS BT* Bluetooth stick – offers a practical way of mobile and wireless maintenance as well as commissioning of NORD frequency inverters.

Access is via the RJ12 diagnostics socket of the frequency inverter. The prerequisite for this is that the bus interface is connected to the frequency inverter via the system bus.

Further documentation and software (www.nord.com)

Software	Description
EDS-file	Electronic Data Sheet (Object data file)

Software	Description
NORDCON	Parametrisation and diagnostic software

Document	Description
BU 0000	Description of NORDCON software
BU 0040	Parameter box manual
BU 0180	Frequency inverter manual NORDAC <i>BASE</i>
BU 0200	Frequency inverter manual NORDAC <i>FLEX</i>
BU 0250	Frequency inverter manual NORDAC <i>LINK</i>

Document	Description
BU 2600	DeviceNet bus communication manual
TI 275274505	SK TIE4-M12-SYSM System bus connection expansion exit
TI 275274506	SK TIE4-M12-SYSS System bus connection expansion entrance
TI 275274515	SK TIE4-M12-CAO-OUT CANopen connection expansion output
TI 275274501	SK TIE4-M12-CAO CANopen connection expansion entrance