

UNICASE[®] Helical Inline Gearboxes Installation and Maintenance Instructions

BIM 1010

USA

CDN

Retain These Safety Instructions For Future Use

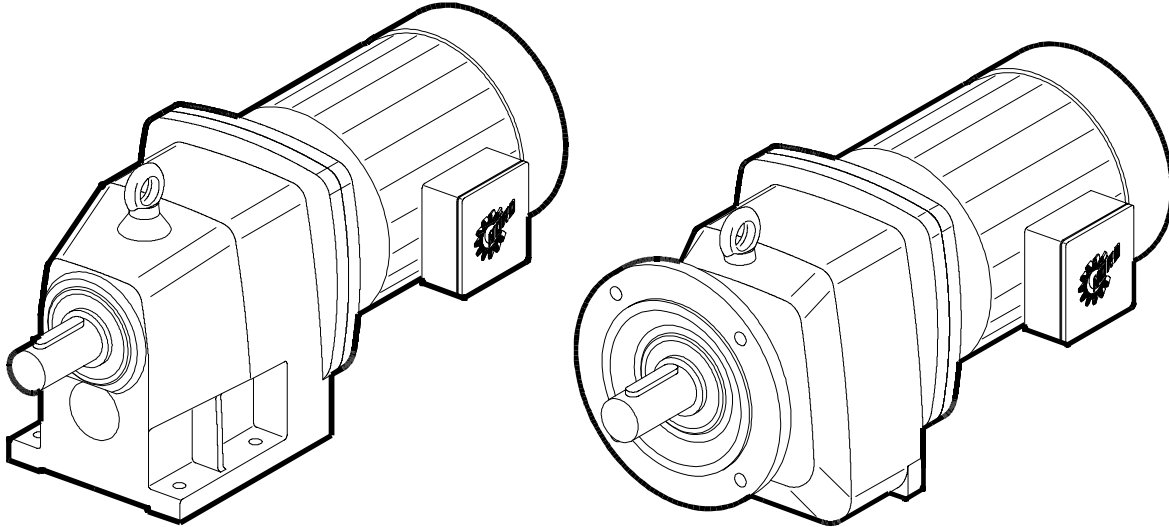

INSPECTION OF UNIT

Thoroughly inspect the equipment for any shipping and handling damage before accepting shipment from the freight company. If any of the goods called for in the bill of lading or express receipt are damaged or the quantity is short, do not accept until the freight or express agent makes an appropriate notation on your freight bill or express receipt. If any concealed loss or damage is discovered later, notify your freight carrier or express agent at once and request him to make an inspection. We will be very happy to assist you in collecting claims for loss or damage during shipment; however, this willingness on our part does not remove the transportation company's responsibility in reimbursing you for collection of claims or replacement of material. Claims for loss or damage in shipment must not be deducted from the NORD Gear invoice, nor should payment of the NORD Gear invoice be withheld awaiting adjustment of such claims, as the carrier guarantees safe delivery.

If considerable damage has been incurred and the situation is urgent, contact the nearest NORD Gear Sales Office for assistance. Please keep a written record of all communications.

RECORD NAMEPLATE DATA

Locate the gear reducer nameplate and record all nameplate data for future reference.

SK _____ S/N _____

RATIO _____ MAX TORQUE _____ RPM _____ MTG. POS _____

STORAGE

PROPER STORAGE UNTIL INSTALLED

Keep unit in a dry, temperature controlled area. If stored other than said, long term storage methods must be applied to the unit including complete fill with lubricant. Protect machined surfaces and rotate shafts periodically. Prior to putting unit into service, drain lubricant and refill to proper level as determined by the mounting position.

PROPER HANDLING OF THE UNIT

Exercise care to prevent damage to the unit when moving. Lift only at designed lifting points. Do not attach other machinery and lift by the unit lifting points. The lifting points are to be used to lift the unit only. Insure that adequate safety measures are taken to protect personnel during transportation. Protect the mounting surface from damage.

INSTALLATION OF UNIT

To ensure long service and dependable performance, an enclosed gear drive must be rigidly supported and the shafts accurately aligned. The following describes the minimum precautions required to accomplish this end.

FOUNDATION

The responsibility for the design and construction of the foundation lies with the user. The foundation must be adequate to withstand normal operating loads and possible overloads while maintaining alignment to attached system components under such loads.

MOUNTING POSITION

Unless a unit is specifically ordered for inclined mounting, the foundation must be level and flat. The lubrication system may not operate properly if the unit is not mounted in the position for which it is designed. It may be desirable to elevate the foundation to facilitate oil drainage.

CONCRETE FOUNDATION

If a concrete foundation is used, steel mounting pads and bolts of sufficient size to distribute the stress into the concrete should be grouted into the foundation.

STEEL FOUNDATION

If a structural steel foundation is used (i.e. wide flange beams or channels), a base plate or sole plate of suitable thickness should be used and should extend under the entire unit.

FOOT MOUNTED UNITS

Use shims under the feet of the unit to align the output shaft to the driven equipment. Make sure that all feet are supported so that the housing will not distort when it is bolted down. Improper shimming will reduce the life of the unit and may cause failure. Dowel pins may be installed to prevent misalignment and ensure proper realignment if removed for service.

FLANGE MOUNTED UNITS

If a structural steel foundation is used (i.e. wide flange beams or channels), a base plate or sole plate of suitable thickness should be used and should extend under the entire unit. If a bulk head plate is used it should be of proper strength to minimize buckling distortions.

Flange Pilot 'AK' or 'AK1' tolerance

Metric (mm)

- > $\varnothing 50 \leq \varnothing 80 = +0.012/-0.007$
- > $\varnothing 80 \leq \varnothing 120 = +0.013/-0.009$
- > $\varnothing 120 \leq \varnothing 180 = +0.014/-0.011$
- > $\varnothing 180 \leq \varnothing 230 = +0.016/-0.013$
- > $\varnothing 230 \leq \varnothing 315 = +0.000/-0.032$
- > $\varnothing 315 \leq \varnothing 400 = +0.000/-0.036$
- > $\varnothing 400 \leq \varnothing 500 = +0.000/-0.040$

Inch

- > $\varnothing 1.969 \leq \varnothing 3.150 = +0.005/-0.0003$
- > $\varnothing 3.150 \leq \varnothing 4.724 = +0.005/-0.0004$
- > $\varnothing 4.724 \leq \varnothing 7.087 = +0.006/-0.0004$
- > $\varnothing 7.087 \leq \varnothing 9.055 = +0.006/-0.0005$
- > $\varnothing 9.055 \leq \varnothing 12.402 = +0.000/-0.0013$
- > $\varnothing 12.402 \leq \varnothing 15.748 = +0.000/-0.0014$
- > $\varnothing 15.748 \leq \varnothing 19.685 = +0.000/-0.0016$

BOLT STRENGTH

Bolt size, strength and quantity should be verified to insure proper torque reaction capacity whatever the mounting arrangement.

PRIME MOVER MOUNTING

Align the prime mover to the reducer-input shaft using shims under the feet. Make sure that the feet are supported. Dowel the prime mover to its foundation.

SHAFT CONNECTIONS

When connecting shafts to either the input or output of the reducer, consider the following instructions.

FITS

Clearance or interference fits for coupling hubs should be in accordance with ANSI/AGMA 9002-A86 or as follows.

Output and Input shaft Diameter tolerance

Metric (mm)

- $\leq \varnothing 18 = +0.012/+0.001$
- > $\varnothing 18 \leq \varnothing 30 = +0.015/+0.002$
- > $\varnothing 30 \leq \varnothing 50 = +0.018/+0.002$
- > $\varnothing 50 \leq \varnothing 80 = +0.030/+0.011$
- > $\varnothing 80 \leq \varnothing 120 = +0.035/+0.013$
- > $\varnothing 120 \leq \varnothing 180 = +0.040/+0.015$

Inch

- $\leq \varnothing 1.750 = +0.0000/-0.0005$
- > $\varnothing 1.750 = +0.0000/-0.0010$

Output and Input shaft Drill and tap shaft end

Metric (mm)

- $\leq \varnothing 16 = M5$
- > $\varnothing 16 \leq \varnothing 21 = M6$
- > $\varnothing 21 \leq \varnothing 24 = M8$
- > $\varnothing 24 \leq \varnothing 30 = M10$
- > $\varnothing 30 \leq \varnothing 38 = M12$
- > $\varnothing 38 \leq \varnothing 50 = M16$
- > $\varnothing 50 \leq \varnothing 85 = M20$
- > $\varnothing 85 \leq \varnothing 130 = M24$

Inch

- $\leq \varnothing 0.438 = \#10-24 \times 0.4 \text{ deep}$
- > $\varnothing 0.438 \leq \varnothing 0.813 = \#1/4-20 \times 0.6 \text{ deep}$
- > $\varnothing 0.813 \leq \varnothing 0.938 = 5/16-18 \times 0.7 \text{ deep}$
- > $\varnothing 0.938 \leq \varnothing 1.125 = 3/8-16 \times 0.9 \text{ deep}$
- > $\varnothing 1.125 \leq \varnothing 1.375 = 1/2-13 \times 1.1 \text{ deep}$
- > $\varnothing 1.375 \leq \varnothing 1.875 = 5/8-11 \times 1.4 \text{ deep}$
- > $\varnothing 1.875 \leq \varnothing 3.250 = 3/4-10 \times 1.7 \text{ deep}$
- > $\varnothing 3.250 = 1-8 \times 2.2 \text{ deep}$

Outboard pinion and sprocket fits should be as recommended by the pin sprockets with interference fits should be heated according to the manufacturer's recommendations, generally 250°F to 300°F, (120°C to 150°C) before assembling to the shaft.

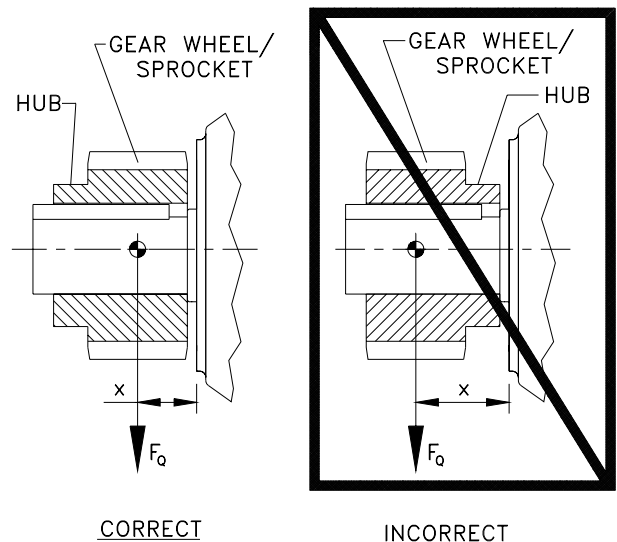

LOCATION

Coupling hubs should be mounted flush with the shaft ends, unless specifically ordered for overhung mounting. Pinions, sprockets and sheaves should be mounted as close as possible to the unit housing to minimize bearing loads and shaft deflections.

COUPLING ALIGNMENT

Shaft couplings should be installed according to the coupling manufacturer's recommendations for gap, angular and parallel alignment. In many installations, it is necessary to allow for thermal and mechanical shaft movement when determining shaft alignment. The coupling manufacturer's recommendations should be followed.

AXIAL DISPLACEMENT

The gap between shaft ends should be the same as the specified coupling gap unless overhung mounting of the coupling hub is specified. The coupling gap and shaft gap must be sufficient to accommodate any anticipated thermal or mechanical axial movement.

ANGULAR ALIGNMENT

Insert a spacer or shim stock equal to the required coupling gap between the coupling hub faces and measure the clearance using feeler gauges. Repeat this at the same depth at 90-degree intervals to determine the amount of angular misalignment.

PARALLEL ALIGNMENT

Mount a dial indicator to one coupling hub, and rotate this hub, sweeping the outside diameter of the other hub. The parallel misalignment is equal to one-half of the total indicator reading. Another method is to rest a straight edge squarely on the outside diameter of the hubs at 90-degree intervals and measure any gaps with feeler gauges. The maximum gap measurement is the parallel misalignment.

CHECKING ALIGNMENT

After both angular and parallel alignments are within specified limits, tighten all foundation bolts securely and repeat the above procedure to check alignment. If any of the specified limits for alignment are exceeded, realign the coupling.

SPROCKET OR SHEAVE ALIGNMENT

Align the sheaves or sprockets square and parallel by placing a straight edge across their faces. Alignment of bushed sheaves and sprockets should be checked after bushings have been tightened. Check horizontal shaft alignment by placing a level vertically against the face of the sheave or sprocket. Adjust belt or chain tension per the manufacturer's specified procedure.

OUTBOARD PINION ALIGNMENT

Align the pinion by adjusting the gear tooth clearance according to the manufacturer's recommendations and checking for acceptable outboard pinion tooth contact. The foundation bolts may have to be loosened and the unit moved slightly to obtain this contact. When the unit is moved to correct tooth contact, the prime mover should be realigned.

RECHECK ALIGNMENT

After a period of operation, recheck alignment and adjust as required.

1. Properly install unit on a rigid foundation
 - adequately supported
 - securely bolted into place
 - leveled so as not to distort the gear case
2. Properly install couplings suitable for the application and connected equipment.
3. Ensure accurate alignment with other equipment.
4. Furnish and install adequate machinery guards as needed to protect operating personnel and as required by the applicable standards of the Occupational Safety and Health Administration (OSHA), and by other applicable safety regulations;

5. Ensure that driving equipment is running in the correct direction before coupling to reducers with backstops (designed to operate only in a specific direction) or machinery designed to operate only in one direction.

CHANGES IN PERFORMANCE SPECIFICATIONS

Owner has the responsibility to consult with NORD GEAR if such items such as applied loads, operating speeds or other operating conditions have changed.



WARNING:

LOCK OUT POWER before any maintenance is performed. Make absolutely sure that no voltage is applied while work is being done on the gearbox.

START-UP

1. Ensure that switches, alarms, heaters, coolers and other safety and protection devices are installed and operational for their intended purpose.
2. Verify that the installed mounting position is the same as the nametag mounting position. If not, adjust the oil level accordingly and relocate the vent plug, fill plug and drain plug according to the mounting position. See following.

AUTOVENT PLUG

The Autovent plug is brass in color and will be located at the highest point on the gearbox. It operates like a check-valve to allow the reducer to relieve internal pressure while preventing lubricant contamination during cooling. A spring presses a ball or plunger against a machined orifice until pressure exceeds 2 psi. Above 2 psi the air is allowed to escape depressurizing the gearcase. When internal pressure drops below 2 psi, the autovent re-seals closing the unit to the outside environment. After shutdown, the reducer cools along with the air inside the reducer. The unit will temporarily maintain a slight vacuum until normalization occurs. NORD Gear supplies an Autovent as a standard feature.

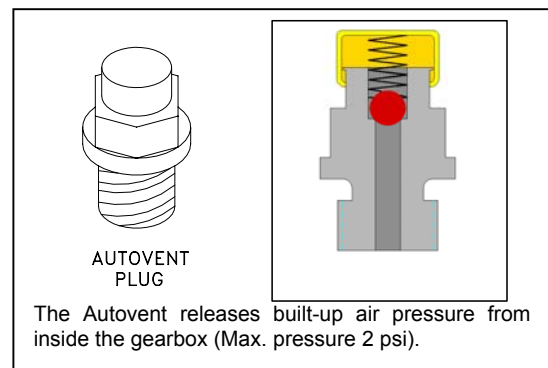

FILL LEVEL & DRAIN PLUGS

The drain plugs are metric socket head cap screws. They will be located at the lowest part of the gearbox for ease of draining. The fill level plug is a hex head cap screw. It will be located between the Autovent and drain plug. Both types of plugs will have gaskets included to prevent oil from leaking.

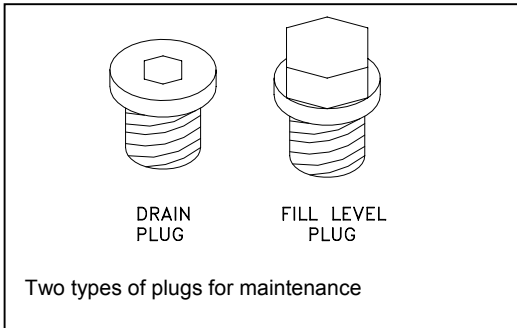

LUBRICANT

All NORD reducers are shipped from the factory properly filled with lubricant and all plugs are installed according to the mounting position given on the reducer nametag. Acceptable oil fill level is within $\frac{1}{2}$ inch of the bottom of the fill plug threads.

OPERATION AND MAINTENANCE CHECKLIST

1. Operate the equipment as it was intended to be operated
2. Do not overload.
3. Run at correct speed.
4. Maintain lubricant in good condition and at proper level.
5. Dispose of used lubricant in accordance with applicable laws and regulations.
6. Apply proper maintenance to attached equipment at prescribed intervals recommended by the manufacturer.
7. Perform periodic maintenance of the gear drive as recommended by NORD.

MOUNTING POSITIONS

These charts detail the mounting positions for horizontal and vertical mounting. The Autovent, oil fill plug and drain plug are indicated on each mounting position picture. The factory set mounting position and plug locations match that shown on the gearbox nametag. For mounting orientations other than shown consult NORD Gear.



VERTICAL POSITION

	SK 11E - SK 51 E	SK 02 - SK 52	SK 03 - SK 53	SK 62 - SK 103
V1 *				
V3				
V5 *				
V6				

Symbols: Vent plug Oil level Drain plug Mounting surface

* Mounting position V1 or V5 with lubricant expansion unit

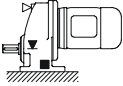
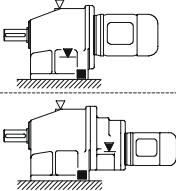
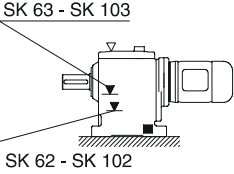
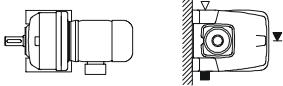
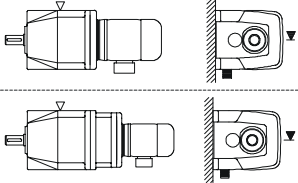
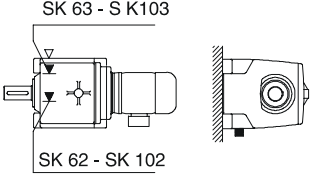
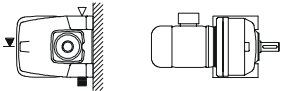
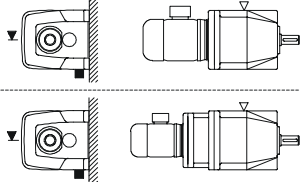
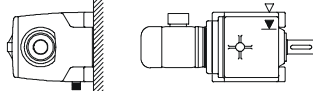
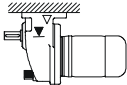
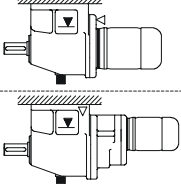
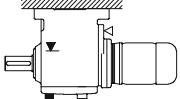
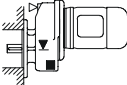
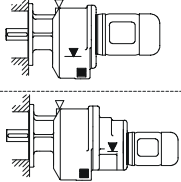
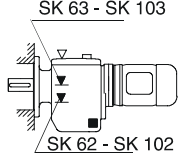
HORIZONTAL POSITION

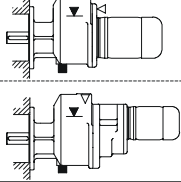
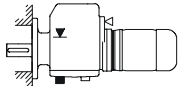
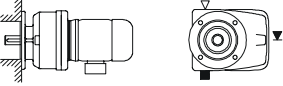
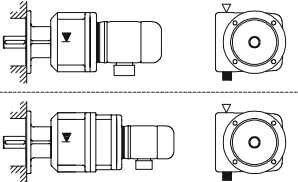
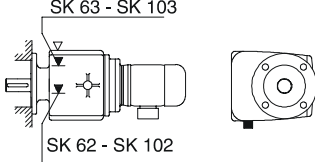
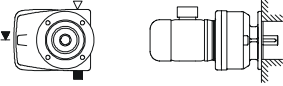
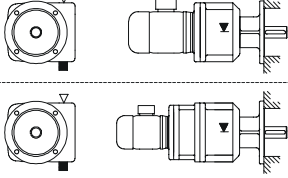
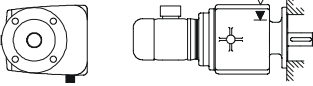
	SK 11 E - SK 51 E	SK 02 - SK 52 SK 03 - SK 53	SK 62 - SK 103
B3			
B6			
B7			
B8			
B5			
B5I			
B5II			
B5III			

Symbols:  Vent plug  Oil level  Drain plug  Mounting surface

MAINTENANCE

Mineral lubricant should be changed every 10,000 service hours or after two years. For synthetic oils, the lube should be changed every 20,000 service hours or after four years. In case of extreme operating (e.g. high humidity, aggressive environment or large temperature variations), shorter intervals between changes are recommended.







OIL SPECIFICATIONS

NORD supplies all reducers filled with oil from the factory. Consult the sticker adjacent to the fill plug to determine the type of lubricant installed at the factory. Standard lubricant is ISO VG220 mineral-based oil. However, some units have special lubricants designed to operate in certain environments or to extend the service life of the lubricant. If in doubt about which lubricant is needed, contact NORD Gear.

STANDARD OIL – ISO VG220

Ambient Temperature	Formulation
20 to 104°F (-5 to 40°C)	Mineral

TYPICAL OILS

Viscosity ISO NLGI	Formulation	Service Temperature Range						
VG 460	Conventional Mineral	20°C to +50°C 68F to +122°F	Mobilgear 634	Omala 460	7EP	Klüberoil GEM 1-460	Energol GR-XP 460	Tribol 1100/460
	Synthetic PAO	-30°C to +80°C -22°F to +176°F	Mobil SHC 634	Omala 460 HD	Isolube EP 460	Klübersynth EG 4-460	N/A	Tribol 1510/460
VG 320	Conventional Mineral	0°C to +30°C 32°F to +86°F	Mobilgear 632	Omala 320	6EP	Klüberoil GEM 1-320	Energol GR-XP 320	Tribol 1100/320
	Synthetic PAO	-35°C to +80°C -31°F to +176°F	Mobil SHC 632	Omala 320 HD	Isolube EP 460	Klübersynth EG 4-320	N/A	Tribol 1510/320
VG 220	Conventional Mineral	-5°C to +40°C +20°F to +104°F	Mobilgear 630	Omala 220	5EP	Klüberoil GEM 1-220	Energol GR-XP 220	Tribol 1100/220
	Synthetic PAO	-34°C to +80°C -30°F to +176°F	Mobil SHC 630	Omala 220 HD	Isolube EP 220	Klübersynth EG 4-220	N/A	Tribol 1510/220
VG 150 & VG 100	Conventional Mineral	-15°C to +25°C 5°F to +77°F	Mobilgear 629	Omala 100	4EP	Klüberoil GEM 1-150	Energol GR-XP 100	Tribol 1100/100
	Synthetic PAO	-37°C to +10°C -35°F to +50°F	Mobil SHC 629	Omala 150 HD	Isolube EP 150	Klübersynth EG 4-150	N/A	N/A
VG 68	Conventional Mineral	-15°C to +25°C 5°F to +77°F	Mobilgear 626	Omala 68	2EP	Klüberoil GEM 1-68	Energol GR-XP 68	Tribol 1100/68
	Synthetic PAO	-40°C to +10°C -40°F to +50°F	Mobil SHC 626	N/A	Isolube EP 68	N/A	N/A	N/A
VG 32	Synthetic PAO	-40°C to +10°C -40°F to +50°F	Mobil SHC 624	N/A	N/A	Klüber-Summit HySyn FG-32	N/A	N/A

PAO = Poly Alpha Olefin

SPECIAL PURPOSE LUBRICANTS

Ambient Temperature	Formulation	Manufacturer	Oil Brand Name
20 to 104°F (-5 to 40°C)	Food Grade Oil - Synthetic	Chevron	FM ISO 220
20 to 104°F (-5 to 40°C)	Food Grade Oil - Synthetic	OilJAX	Magnaplate 85W/140-FG
5 to 125°F (-20 to 50°C)	Fluid Grease	Mobil	Mobilux EP023
-30 to 140°F (-35 to 60°C)	Fluid Grease - Synthetic	Mobil	Mobilith SHC 007
-30 to 140°F (-35 to 60°C)	Fluid Grease - Synthetic	Shell	Albida LC

STANDARD BEARING GREASE – NLGI 2EP Lithium

Ambient Temperature	Formulation
-20 to 140°F (-30 to 60°C)	Mineral

OPTIONAL BEARING GREASES

Ambient Temperature	Formulation	Manufacturer	Grease Brand Name
-40 to 230°F (-40 to 110°C)	Synthetic	Shell	Aeroshell 6
-40 to 230°F (-40 to 110°C)	Food Grade - Synthetic	Lubriplate	SFL1

LUBRICANT CAPACITY

Each reducer has the oil level and oil quantity adjusted according to the mounting position shown in the tables. When replacing the oil, consult the tables below to determine the proper amount of oil to be installed according to the reducer size and mounting position. Note that this is approximate and the final level will be adjusted when the reducer is installed. Acceptable oil fill level is within 1/2 inch of the bottom of the fill plug threads.

LUBRICATION CAPACITY – HELICAL INLINE GEARBOXES													
Mounting position		Horizontal position								Vertical position			
		single reduction											
		B 3	B 6	B 7	B 8	B 5	B 5I	B 5II	B 5III	V 1	V 3	V 5	V 6
SK 11E	quarts	0.26	0.37	0.37	0.58	0.32	0.53	0.42	0.42	0.32	0.37	0.42	0.53
	liters	0.25	0.35	0.35	0.55	0.30	0.50	0.40	0.40	0.30	0.35	0.40	0.50
SK 21E	quarts	0.63	1.06	1.06	1.27	0.53	1.16	0.95	0.95	0.74	1.48	1.06	1.27
	liters	0.60	1.00	1.00	1.20	0.50	1.10	0.90	0.90	0.70	1.40	1.00	1.20
SK 31E	quarts	1.16	1.80	1.80	2.32	0.85	1.74	2.11	2.11	1.16	1.37	2.43	2.85
	liters	1.10	1.70	1.70	2.20	0.80	1.65	2.00	2.00	1.10	1.30	2.30	2.70
SK 41E	quarts	1.80	2.75	2.75	3.49	1.06	2.96	3.49	3.49	1.69	2.75	2.64	2.75
	liters	1.70	2.60	2.60	3.30	1.00	2.80	3.30	3.30	1.60	2.60	2.50	2.60
SK 51E	quarts	2.32	3.59	3.59	4.97	1.90	4.33	4.02	4.02	3.17	3.70	4.23	4.65
	liters	2.20	3.40	3.40	4.70	1.80	4.10	3.80	3.80	3.00	3.50	4.00	4.40
Mounting position		double reduction											
		B 3	B 6	B 7	B 8	B 5	B 5I	B 5II	B 5III	V 1	V 3	V 5	V 6
SK 02	quarts	0.16	0.42	0.42	0.74	0.26	0.63	0.53	0.53	0.63	0.63	0.63	0.63
	liters	0.15	0.40	0.40	0.70	0.25	0.60	0.50	0.50	0.60	0.60	0.60	0.60
SK 12	quarts	0.26	0.53	0.53	0.90	0.37	0.95	0.63	0.63	0.95	0.90	0.79	0.79
	liters	0.25	0.50	0.50	0.85	0.35	0.90	0.60	0.60	0.90	0.85	0.75	0.75
SK 22	quarts	0.53	1.43	1.43	2.11	0.74	2.11	1.64	1.64	1.90	2.11	1.90	1.90
	liters	0.50	1.35	1.35	2.00	0.70	2.00	1.55	1.55	1.80	2.00	1.80	1.80
SK 32	quarts	0.95	2.11	2.11	3.17	1.37	3.49	2.54	2.54	3.28	3.06	3.06	2.64
	liters	0.90	2.00	2.00	3.00	1.30	3.30	2.40	2.40	3.10	2.90	2.90	2.50
SK 42	quarts	1.37	3.38	3.38	4.76	1.90	4.76	3.91	3.91	4.23	4.65	4.54	6.13
	liters	1.30	3.20	3.20	4.50	1.80	4.50	3.70	3.70	4.00	4.40	4.30	5.80
SK 52	quarts	2.64	5.39	5.39	7.19	3.17	6.55	5.92	5.92	7.82	7.19	7.19	7.40
	liters	2.50	5.10	5.10	6.80	3.00	6.20	5.60	5.60	7.40	6.80	6.80	7.00
SK 62	quarts	6.87	15.85	15.85	13.74	7.40	14.79	16.91	16.91	19.55	15.85	16.91	15.85
	liters	6.50	15.00	15.00	13.00	7.00	14.00	16.00	16.00	18.50	15.00	16.00	15.00
SK 72	quarts	9.51	24.30	24.30	19.02	10.57	19.55	24.30	24.30	29.59	24.30	27.47	24.30
	liters	9.00	23.00	23.00	18.00	10.00	18.50	23.00	23.00	28.00	23.00	26.00	23.00
SK 82	quarts	14.79	33.81	33.81	28.53	15.85	30.64	36.46	36.46	47.55	39.10	46.49	36.98
	liters	14.00	32.00	32.00	27.00	15.00	29.00	34.50	34.50	45.00	37.00	44.00	35.00
SK 92	quarts	26.42	54.95	54.95	49.66	27.47	49.66	54.95	54.95	82.42	77.14	80.31	77.14
	liters	25.00	52.00	52.00	47.00	26.00	47.00	52.00	52.00	78.00	73.00	76.00	73.00
SK 102	quarts	38.04	75.02	75.02	69.74	42.27	69.74	76.08	76.08	109.90	85.59	107.78	83.48
	liters	36.00	71.00	71.00	66.00	40.00	66.00	72.00	72.00	104.00	81.00	102.00	79.00
Mounting position		triple reduction											
		B 3	B 6	B 7	B 8	B 5	B 5I	B 5II	B 5III	V 1	V 3	V 5	V 6
SK 03	quarts	0.32	0.63	0.63	0.85	0.53	0.95	0.85	0.85	1.16	0.86	0.95	1.32
	liters	0.30	0.60	0.60	0.80	0.50	0.90	0.80	0.80	1.10	0.81	0.90	1.25
SK 13	quarts	0.63	0.74	0.74	1.16	0.85	1.27	1.00	1.00	1.27	1.27	1.27	1.32
	liters	0.60	0.70	0.70	1.10	0.80	1.20	0.95	0.95	1.20	1.20	1.20	1.25
SK 23	quarts	1.37	1.69	1.69	2.43	2.64	1.59	2.96	2.96	2.96	2.75	2.48	2.54
	liters	1.30	1.60	1.60	2.30	2.50	1.50	2.80	2.80	2.80	2.60	2.35	2.40
SK 33	quarts	1.69	2.43	2.43	3.38	2.01	3.70	2.75	2.75	4.65	3.59	4.44	3.06
	liters	1.60	2.30	2.30	3.20	1.90	3.50	2.60	2.60	4.40	3.40	4.20	2.90
SK 43	quarts	3.17	3.80	3.80	5.49	3.70	5.28	4.33	4.33	6.45	6.02	6.97	5.92
	liters	3.00	3.60	3.60	5.20	3.50	5.00	4.10	4.10	6.10	5.70	6.60	5.60
SK 53	quarts	4.76	6.34	6.34	8.14	5.49	7.40	7.08	7.08	9.40	8.88	9.19	9.19
	liters	4.50	6.00	6.00	7.70	5.20	7.00	6.70	6.70	8.90	8.40	8.70	8.70
SK 63	quarts	10.57	13.74	13.74	11.62	11.62	12.68	14.79	14.79	19.02	14.79	16.91	15.32
	liters	10.00	13.00	13.00	11.00	11.00	12.00	14.00	14.00	18.00	14.00	16.00	14.50
SK 73	quarts	14.79	21.13	21.13	18.49	14.79	19.02	21.13	21.13	29.06	23.78	28.53	21.13
	liters	14.00	20.00	20.00	17.50	14.00	18.00	20.00	20.00	27.50	22.50	27.00	20.00
SK 83	quarts	23.25	34.87	34.87	27.47	24.30	28.53	35.93	35.93	42.27	35.93	39.10	32.76
	liters	22.00	33.00	33.00	26.00	23.00	27.00	34.00	34.00	40.00	34.00	37.00	31.00
SK 93	quarts	42.27	51.78	51.78	46.49	42.27	46.49	51.78	51.78	78.19	73.97	76.08	73.97
	liters	40.00	49.00	49.00	44.00	40.00	44.00	49.00	49.00	74.00	70.00	72.00	70.00
SK 103	quarts	58.12	70.80	70.80	58.12	58.12	62.34	70.80	70.80	104.61	82.42	102.50	75.02
	liters	55.00	67.00	67.00	55.00	55.00	59.00	67.00	67.00	99.00	78.00	97.00	71.00

Note: Filling quantities are approximate figures. Oil level must be checked according to oil level plug after final installation. Acceptable oil fill level is within 1/2 inch of the bottom of the fill plug threads. For mounting angles not shown, consult factory.

PARTS LIST

SK 11 E - SK 51 E

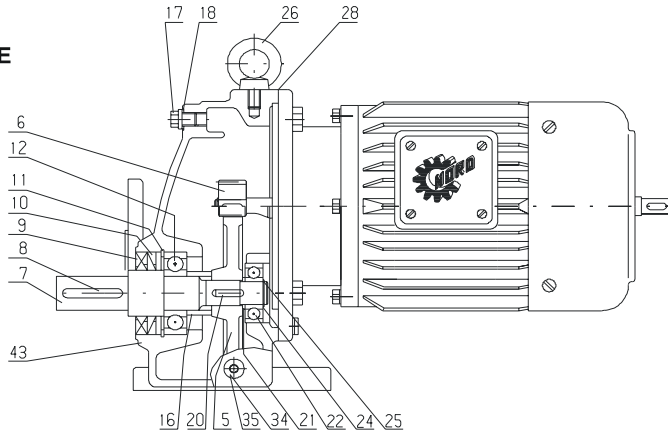

SK 02 - SK 52

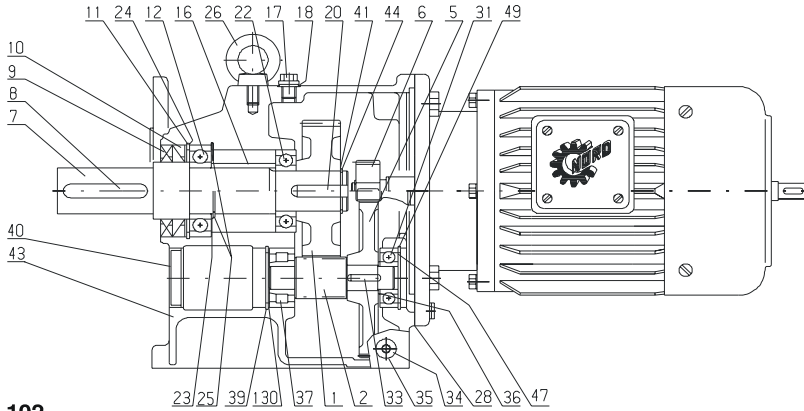

SK 62 - SK 102

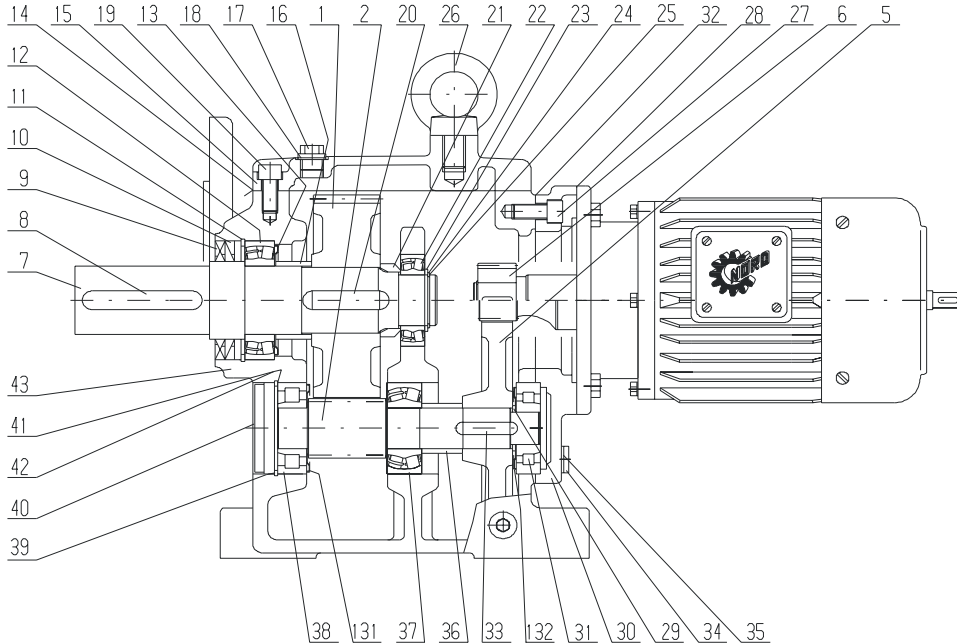

- 1 Driven gear
- 2 Pinion shaft
- 5 Driving gear
- 6 Driving pinion
- 7 Output shaft
- 8 Key
- 9 Shaft seal
- 10 Shaft seal
- 11 Circlip
- 12 Output shaft bearing
- 13 NILOS ring
- 14 Seal
- 15 Gearcase cover
- 16 Spacer
- 17 Vent plug
- 18 Seal
- 19 Socket head screw
- 20 Key
- 21 Spacer
- 22 Output shaft bearing
- 23 Supporting disc
- 24 Shim
- 25 Circlip
- 26 Flanged eye bolt
- 27 Bolt
- 28 Seal
- 29 Spacer
- 30 Gearbox cover
- 31 Pinion shaft bearing
- 32 Seal
- 33 Key
- 34 Drain plug
- 35 Seal
- 36 Spacer
- 37 Pinion shaft bearing
- 38 Pinion shaft bearing
- 39 Circlip
- 40 Locking cap
- 41 Shim
- 42 Supporting disc
- 43 Gear case
- 44 Circlip
- 47 Shim
- 49 Circlip
- 130 Shim
- 131 NILOS ring
- 132 NILOS ring

RECOMMENDED SPARE PARTS

Bearings – all Gaskets – all Shims – all
 Seals – all Seal Plugs – all

IMPORTANT!

When ordering parts, it is necessary to have the **NORD SERIAL NUMBER** from the unit the parts are for. The serial number will dictate the correct parts for that particular unit. The gearbox nameplate will have the serial number on it.

PARTS LIST

SK 03 - SK 53

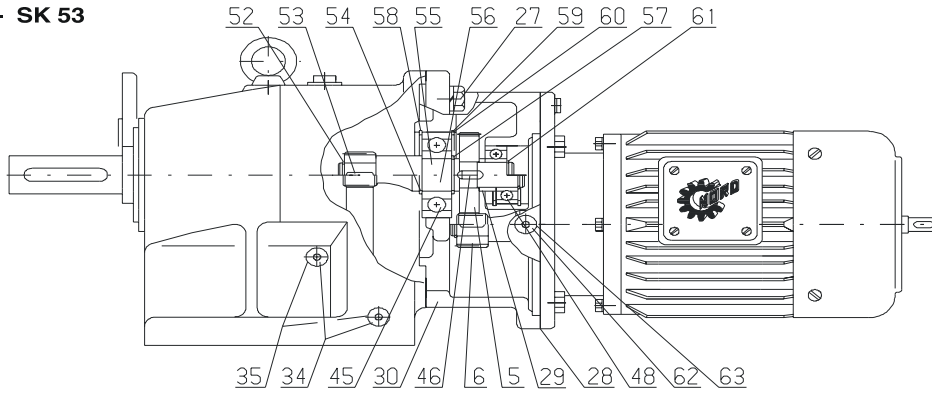

SK 63 - SK 103

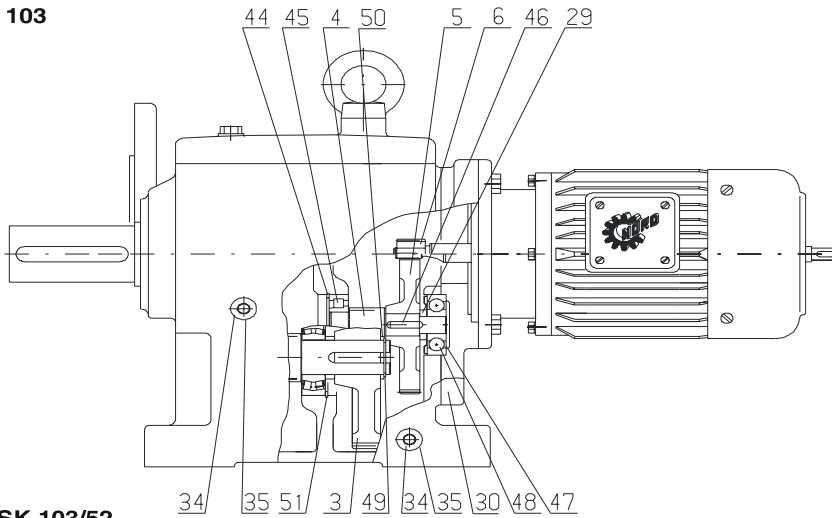

SK 12/02 - SK 103/52

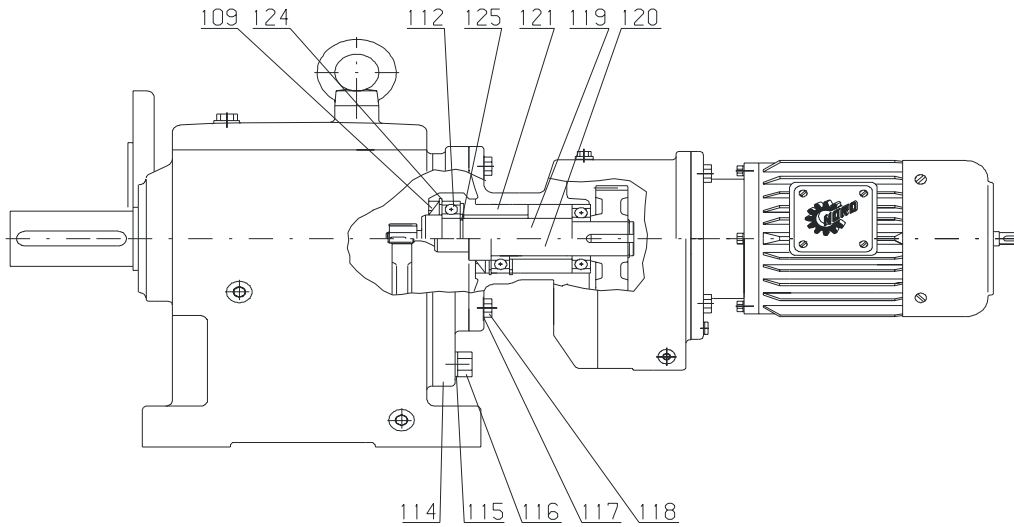

- 3 Driven gear
- 4 Pinion shaft
SK 63 - SK 103
- 5 Driving gear
- 6 Driving pinion
- 27 Fixing bolt
- 28 Seal
- 29 Spacer
- 30 Third reduction gearcase
- 34 Drain plug
- 35 Seal
- 44 Circlip
- 45 Ball bearing
- 46 Key
- 47 Shim
- 48 Ball bearing
- 49 Circlip
- 50 Supporting disc
- 51 Circlip
- 52 Circlip
- 53 Key
- 54 Circlip
- 55 Intermediate shaft, plain
- 56 Intermediate shaft, gearcut
- 57 Circlip
- 58 Circlip
- 59 Shim
- 60 Circlip
- 61 Circlip
- 62 Oil-plug
- 63 Seal
- 109 Shaft seal
- 112 Ball bearing
- 114 Intermediate flange
- 115 Spring washer
- 116 Bolt
- 118 Bolt
- 119 Intermediate shaft, plain
- 120 Intermediate shaft, gearcut
- 121 Bearing sleeve
- 124 Circlip
- 125 Circlip

NOTES

TROUBLE SHOOTING

PROBLEM WITH THE REDUCER		POSSIBLE CAUSES	SUGGESTED REMEDY
Runs Hot	Overloading	Load exceeds the capacity of the reducer	Check rated capacity of reducer, replace with unit of sufficient capacity or reduce load
	Improper lubrication	Insufficient lubrication	Check lubricant level and adjust up to recommended levels
		Excessive lubrication	Check lubricant level and adjust down to recommended levels
		Wrong lubrication	Flush out and refill with correct lubricant as recommended
Runs Noisy	Loose foundation bolts	Weak mounting structure	Inspect mounting of reducer. Tighten loose bolts and/ or reinforce mounting and structure
		Loose hold down bolts	Tighten bolts
	Worn RV Disc	Overloading unit may result in damage to disc	Disassemble and replace disc. Recheck rated capacity of reducer.
	Failure of Bearings	May be due to lack of lubricant	Replace bearing. Clean and flush reducer and fill with recommended lubricant.
		Overload	Check rated capacity of reducer.
Insufficient Lubricant	Level of lubricant in the reducer not properly maintained.	Check lubricant level and adjust to factory recommended level.	
Output Shaft Does Not Turn	Internal parts are broken	Overloading of reducer can cause damage.	Replace broken parts. Check rated capacity of reducer.
		Key missing or sheared off on input shaft.	Replace key.
		Coupling loose or disconnected.	Properly align reducer and coupling. Tighten coupling.
Oil Leakage	Worn Seals	Caused by dirt or grit entering seal.	Replace seals. Autovent may be clogged. Replace or clean.
		Overfilled reducer.	Check lubricant level and adjust to recommended level.
		Autovent clogged.	Clean or replace, being sure to prevent any dirt from falling into the reducer.
		Improper mounting position, such as wall or ceiling mount of horizontal reducer.	Check mounting position. Name tag & verify with mounting chart in manual.

NORD Gear Corporation

National Customer Service Toll Free 888-314-6673

www.nord.com

NORD Gear Limited

Toll Free in Canada 800-668-4378

WEST

1121 Railroad Street
Building 101
Corona, CA 92882
Phone 951-279-2600
Fax 888-408-6673

MIDWEST

PO Box 367
800 Nord Drive
Waunakee, WI 53597
Phone 608-849-7300
Fax 800-373-6673

SOUTH

100 Forsyth Hall Dr.
Building 100B
Charlotte, NC 28273
Phone 704-529-1255
Fax 888-259-6673

CANADA

41 West Drive
Brampton, Ontario L6T 4A1
Phone 905-796-3606
Fax 905-796-8130