

SK CU4-CAO

Part number: 275 271 001

CANopen® – Internal Bus Interface

The bus interface may only be installed and commissioned by qualified electricians. An electrician is a person who, because of their technical training and experience, has sufficient knowledge with regard to

- Switching on, switching off, isolating, earthing and marking power circuits and devices,
- Proper maintenance and use of protective devices in accordance with defined safety standards.

⚠ DANGER

Danger of electric shock

The frequency inverter carries hazardous voltage for up to 5 minutes after being switched off.

- Work must not be carried out unless the frequency inverter has been disconnected from the voltage and at least 5 minutes has elapsed since the mains was switched off!

NOTICE

Validity of document

This document is only valid in conjunction with the operating instructions of the respective frequency inverter and the bus communication manual for this bus interface (📖 See overview at end of document). These documents contain all of the information that is required for safe commissioning of the bus interface module and the frequency inverter.

Scope of delivery

1 x	Bus interface	SK CU4-CAO
1 x	System bus cable set	grey/black
1 x	24 VDC cable set	brown/blue
2 x	Connecting screws	M4 x 20, cross-head



Usage area

Internal interface for connecting a decentralised frequency inverter (SK 180E...SK 2xxE) to a **CANopen** field bus. This is connected to the inverter via the system bus, and can directly access up to 4 frequency inverters. 2 digital inputs are available.

Technical Information / Datasheet	SK CU4-CAO			
CANopen Bus module	TI 275271001	V 1.0	4116	EN

Technical Data

Bus interface

Temperature range	-25 °C...50 °C	Vibration resistance	3M7
Temperature class	Class 3K3	Firmware version	V2.2 R2
Protection class	IP20	Supply voltage	24 V ± 20 %, ≈ 100 mA Reverse polarity protected

Digital input - working range	Low: 0 V ... 5 V, High: 11 V ... 30 V
Digital input - specific data	R _i = 8.1 kΩ, input capacity: 10 nF, response time 1 ms, inputs as per EN 61131-2 type 1

Bus specification

CANopen	Max. 1 MBit/s			
	electrical isolation 500 V _{eff}			
Bus connection	Screw terminals			
Bus termination	via DIP switch on the bus interface			
Status display	6 LEDs			
Topology	Linear bus			
Cable	twisted, shielded two-conductor cable			
Cable length	depending on transmission speed:			
	Bus cable length	Resistance	Cross-section	Transfer rate
	Up to 25 m	70 mΩ/m	≥ 0.25 mm ² , AWG23	1 Mbit/s
	25...50 m	70 mΩ/m	≥ 0.25 mm ² , AWG23	800 KBit/s
	50...80 m	< 60 mΩ/m	≥ 0.34 mm ² , AWG22	500 KBit/s
	80...230 m	< 40 mΩ/m	≥ 0.5 mm ² , AWG21	250 KBit/s
	230...480 m	< 26 mΩ/m	≥ 0.75 mm ² , AWG18	125 KBit/s
	480...1000 m	< 20 mΩ/m	≥ 1 mm ² , AWG...	50 KBit/s
Shield	Direct to PE			
PE connection	via PE screw cap in terminal box			

Power

Update interval for process data between bus interface and frequency inverter	≤ 8 ms ^{1,2}
Parameter read/write access on the frequency inverter	> 20 ms ²

¹ depending on bus utilisation

² depending on the setting of the **P153 min. system bus cycle** parameter

Bus interface characteristics

Parametrisation	CANopen via SDO
Addressing	via DIP switch
Setting the baud rate	via DIP switch
Supported CANopen profile	Communication profile DS -301
	Drive profile DS -402
Error Messages (Emergency Messages)	to CANopen communication profile DS-301
Access for NORD diagnosis tool via	diagnostics socket on the device (if available) and via frequency inverter

Installation

Installation location	Within the connection unit of a frequency inverter (SK 180E, SK 190E, 2xxE)
Fastening	with screw fastenings

Installation steps

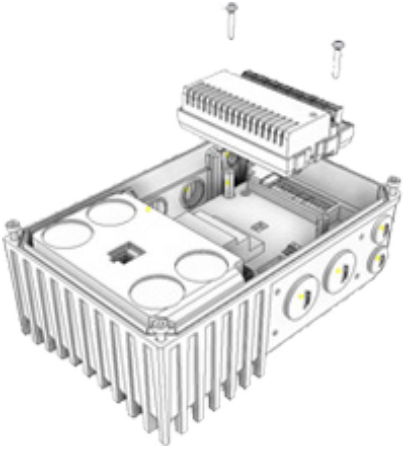
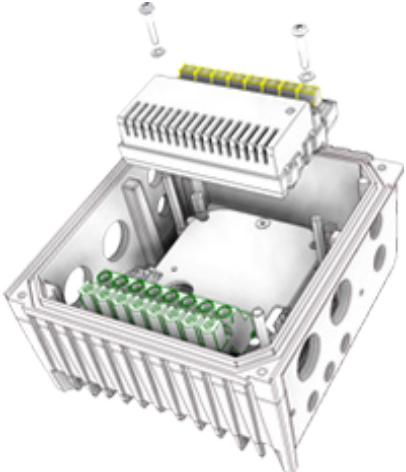
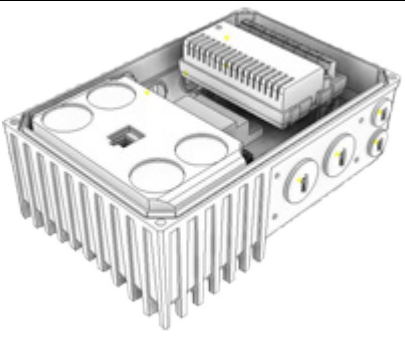
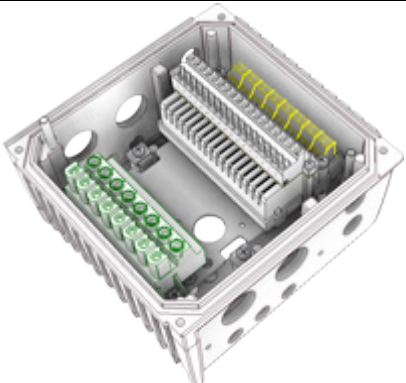
	SK 1xxE	SK 2xxE
1.		
2.		

Connections

Connection is via the terminal strip of the bus interface.

Potential	Contact	Designation	Description	
1	System bus level and digital inputs	44	24 V	Supply potential (+24 V ±20%, 50 mA)
		40	GND	Reference potential (0 V/GND)
		C1	DIN1	Digital input 1
		C2	DIN2	Digital input 2
		77	Sys +	System bus data line +
		78	Sys -	System bus data line -
		40	GND	Reference potential (0 V/GND)
2	CANopen	45	24 V Bus	24 V supply voltage field bus
		75	CANopen+	CANopen connection 1 Receive Data + (CAN H)
		76	CANopen	CANopen connection 1 Receive Data - (CAN L)
		46	GND Bus	Bus reference potential
		90	SHLD	Bus shield
		45	24 V Bus	Supply potential (+24 V ±20%, 50 mA)
		75	CANopen+	CANopen connection 2 Transmit Data +
		76	CANopen	CANopen connection 2 Transmit Data -
46	GND Bus	Bus reference potential		

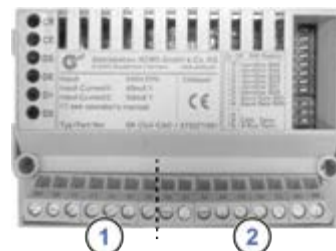

Schematic diagram - electrical connection

(Terminal designation for the example of NORD frequency inverters SK 180E ... SK 2xxE)

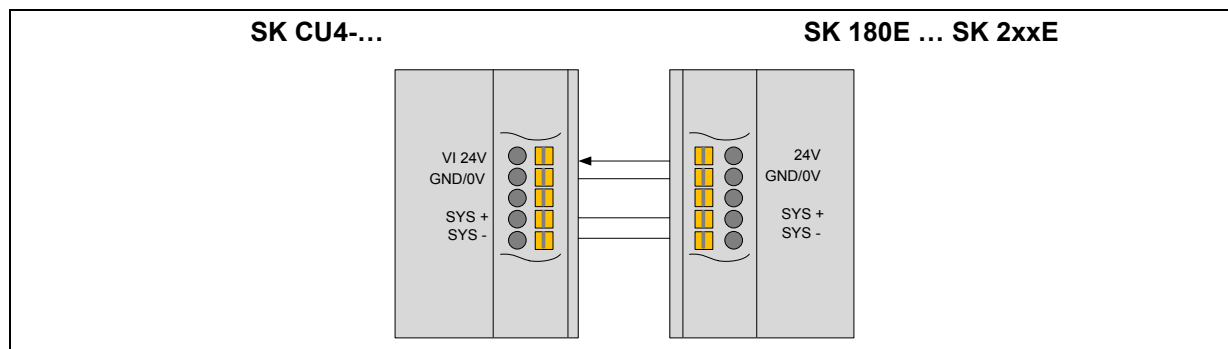

Configuration

The bus address (node ID), the bus interface (1) and the baud rate (2) are set via the DIP switches. The DIP switch setting results in the node identifier, which is read after a “Power On” of the bus interface.

If the bus interface is the final subscriber on the CANopen field bus or the NORD system bus, the terminating resistor (3) must be activated.

DIP switch	Meaning	Department	Meaning
8	Identifier bit 5	Addressing	Bus address (Node ID) of bus interface
7	Identifier bit 4		
6	Identifier bit 3		
5	Identifier bit 2		
4	Identifier bit 1		
3	Identifier bit 0	Baud rate	Bus interface baud rate
2	Baud rate bit 1		
1	Baud rate bit 0	Bus terminal	Not used
E	—		Termination resistor for CANopen field bus
2	CANopen		Termination resistor for NORD system bus
1	System bus		

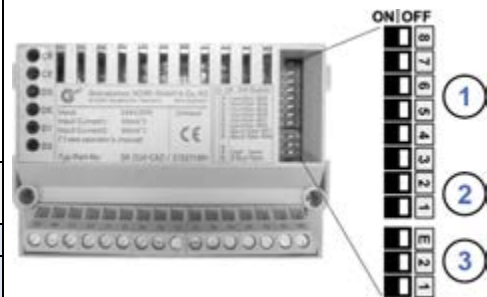

1. Addressing (DIP 8 ... 3)

The setting of the node ID takes place with binary coding using DIP switches 8...3.

Address area "1"... "63".

2. Baud rate (DIP 2 ... 1)

The setting of the node ID takes place with binary coding using DIP switches 2...1.

DIP switch 2	DIP switch 1	Baud rate
OFF	OFF	125 kBaud
OFF	ON	250 kBaud
ON	OFF	500 kBaud
ON	ON	1 MBaud

3. Termination resistor (DIP E... 1)

Set DIP switch 2 to the “ON” position if the bus interface is the final subscriber on the field bus. Set DIP switch 1 to the “ON” position if the bus interface is the final subscriber on the NORD system bus.

LED indicators

The operating statuses of the bus interface are visualised using LED indicators.

No.	Name	Colour	Meaning
1	CR	green	CANopen State
	CE	red	CANopen Error
2	DS	green	Device State
	EN	red	Device error
3	D1	green	Digital input D1
	D2	green	Digital input D2



CANopen-specific LED

CR (CANopen State)	Meaning
OFF	No operating voltage, initialisation
Flashing green (1 s)	CANopen operating state "stopped"
Flashing green (0.5 s)	CANopen operating state "pre-operational"
Flashing green (0.25 s)	No other subscribers on the bus or wiring defective (only if the "CE" LED is flashing)
Green ON	CANopen operating state "operational"

CE (CANopen Error)	Meaning
OFF	No error
Flashing red	Bus warning, error counter of the CANopen controller has reached or exceeded the warning limit. → Check wiring / shielding / termination resistors. CANopen error → there is no physical connection to another subscriber
Red ON	CANopen controller disconnected from bus, since a serious error has occurred such as <ul style="list-style-type: none"> Wiring error Incorrect baud rate set

NORD-specific LEDs

DS (Device State)	EN (Device Error)	Meaning long flashing = 0.5 s on / 1 s off short flashing = 0.25 s on / 1 s off
OFF	OFF	Bus interface not ready, no control voltage
ON	OFF	Bus interface ready, no error, at least one frequency inverter is communicating via the system bus
ON	Short flashing	Bus interface ready, but <ul style="list-style-type: none"> One or more of the connected frequency inverters has fault status
Long flashing	OFF	Bus interface ready and at least one other subscriber is connected to the system bus, but <ul style="list-style-type: none"> No frequency inverter on the system bus (or connection interrupted) One or more system bus subscriber has an address error Software incompatible (bus interface software and FI software incompatible - update required)
Long flashing	Short flashing Flash interval 1 x - 1s pause	System bus is in status "Bus Warning" <ul style="list-style-type: none"> Communication on system bus disrupted No other subscribers present on system bus Module not inserted correctly or no connection to system bus Frequency inverter has no supply voltage
Long flashing	Short flashing Flash interval 2 x - 1s pause	System bus is in status "Bus Off" <ul style="list-style-type: none"> The system bus 24 V power supply has been interrupted during operation
Long flashing	Short flashing Flash interval 3 x - 1s pause	System bus is in status "Bus Off" <ul style="list-style-type: none"> The 24V voltage supply of the system bus is missing
Long flashing	Short flashing Flash interval 4 x - 1s pause	Bus interface error <ul style="list-style-type: none"> See parameter P170
OFF	Short flashing Flash interval 1..7 - 1s pause	System error, internal program sequence interrupted <ul style="list-style-type: none"> EMC interference (observe the wiring guidelines!) Bus interface defective

Digital input LEDs

LED (green)	Display		Meaning
D1	ON		"High" potential present at terminal "C1".
		OFF	"Low" potential present at terminal "C1".
D2	ON		"High" potential present at terminal "C2".
		OFF	"Low" potential present at terminal "C2".

Error messages

Error messages from the bus interface - current or archived message relating to the last fault - can be read out via module parameter **P170**. The error messages are lost if the bus interface is switched off.

Error	Meaning	Remarks
100.0	EEPROM error	EMC faults, bus interface defective
101.0	System bus 24 V missing	No 24 V voltage on bus, connections not correct
102.0	Bus timeout P151	By means of timeout supervision parameter P151/P513
103.0	System bus BUS OFF	No 24 V supply to the bus, connections not correct
511.0	CANopen BUS OFF	Bus subscriber not connected to bus
511.1	CANopen warning	Bus error
511.2	CANopen overrun	Message buffer of bus interface overwritten with new telegram before processing
511.3	Invalid CANopen address	Incorrect/duplicated bus address
512.0	CANopen timeout	Telegram transfer error

Bus interface-related errors are depicted as follows in the error memory of the frequency inverter (**P700 / P701**).

Error (E010)	Meaning	Remarks
10.2	External bus interface telegram timeout	Telegram transfer error <ul style="list-style-type: none"> Check the connections and links, program sequence and Bus Master.
10.3	Timeout by P151/P513	System bus supervision has triggered. <ul style="list-style-type: none"> Check time setting of parameter P151/P513. The release bit is missing in the control word.
10.4	External bus interface initialisation error	Unable to address bus interface. <ul style="list-style-type: none"> Check power supply of bus interface.
10.8	External bus interface communication error	SK TU3-CAO bus interface only: Connection between bus interface and frequency inverter interrupted.
10.9	Bus interface missing (P120)	Only bus interfaces SK CU4-CAO and SK TU4-CAO: Connection between bus interface and frequency inverter interrupted (see setting of parameter P120).

Parameters

Frequency inverter: The following frequency inverter parameters must be adapted for setting up communication between the frequency inverter and the bus interface (for details please refer to the frequency inverter manual).



Parameter [-Array]	Meaning	Remarks
P120 [-01]	Option monitoring	"Auto" (default setting) Only SK xU4
P509	Source Control Word	SK TU3-... on SK 5xxE: "Ethernet TU" SK xU4-... on SK 180/SK 2xxE: "System bus"
P510 [-01]...[-02]	Setpoint source	"Auto" (default setting)
P513	Time-out	Monitoring of the SK TU3 bus interface Only SK 5xxE
P543 [-01]...[-03] ([-05]) and P543 ... P545	Bus actual value (1...3 (...5))	Possible settings according to P418
P546 [-01]...[-03] ([-05]) and P546 ... P548	Bus setpoint value (1...3 (...5))	Possible settings according to P400
P700 [-01]/ P701	Current/last faults	Information parameter
P740 / P741	Process data bus In / Out	Information parameter
P745	Module version	Information parameter Only SK TU3
P746	Module status	Information parameter Only SK TU3
P748	CANopen/System bus status	Information parameter

Bus interface: The bus interface provides a selection of appropriate parameters for setting or displaying special operating values. Parameters can be adapted using the NORDCON software or an SK PAR-3H / -3E parameter box. All parameters can still be read and written by the bus master via CANopen.

Parameter [-Array]	Meaning	Remarks
P150	Set relays	Set DOUT directly or control via BUS
P151	External bus time-out	Monitoring of SK xU4 bus interface
P152	Factory setting	Reset bus interface parameters
P153 [-01]...[-02]	Minimum system bus cycle	Reduction of bus load on the system bus caused by the bus interface
P154 [-01]...[-02]	Access to option card I/O	Administration of read and write rights to the IO of the module
P160 [-01]...[-10]	COB-ID On/Off	Assignment of process data and service data objects
P161 [-01]...[-19]	COB-ID	Assignment of COB-ID for process data and service data objects
P162 [-01]...[-10]	PDO transmission type	Confirm transmission type for process data objects
P163 [-01]...[-05]	TxPDO Inhibit time	Confirm transmission break for process data objects
P164 [-01]...[-05]	TxPDO Event time	Confirm delay time for process data transfer
P165 [-01]...[-34]	PDO Mapping Para	Specify PDO objects
P166 [-01]...[-02]	Timeout Control	Set supervision interval
P167	Life time factor	Set supervision factor
P168 [-01]...[-17]	Drive profile	Set profile parameters (velocity mode)
P170 [-01]...[-02]	Present errors	Display bus interface errors
P171 [-01]...[-03]	Software version	Firmware version/Revision
P172	Configuration	Bus interface type
P173	Module status	Status of system bus or the connected FI
P174	Status of digital inputs	Image of the switching status of DIN
P175	Digital output state	Image of the switching status of DOUT
P176 [-01]...[-17]	Process data bus In	Information parameter
P177 [-01]...[-17]	Process data bus Out	Information parameter
P180	CANopen address	Information parameter
P181	CANopen baud rate	Information parameter

Parameter access and diagnostics

The NORD CON software and optional control units such as the SK PAR-3H parameter box provide convenient access to the parameters of the bus interface and allow status information to be read out.

SK TU3-	SK TU4-	SK CU4- / SK TU4-
Access via RJ12 diagnostics socket of the SK 5xxE	Access via RJ12 diagnostics socket of the bus connection unit SK TI4-TU-BUS(-C)	Access via RJ12 frequency inverter diagnostics socket, if connected to the bus interface via the system bus.
		

Further documentation and software (www.nord.com)

Software	Description
EDS-file	Device characteristics and parameters

Software	Description
NORD CON	Parametrisation and diagnostic software

Document	Description
BU 0000	Description of NORD CON software
BU 0040	Parameter box manual
BU 0180	Frequency inverter manual SK 180E, SK 190E
BU 0200	Frequency inverter manual SK 2xxE
BU 2500	Description of CANopen bus communication

Document	Description
TI 275274505	SK TIE4-M12-SYSM System bus connection expansion exit
TI 275274506	SK TIE4-M12-SYSS System bus connection expansion entrance
TI 275274515	SK TIE4-M12-CAO-OUT CANopen connection expansion output
TI 275274501	SK TIE4-M12-CAO CANopen connection expansion entrance